

SULZER

Nordic Water

Filtration solutions

DynaDisc microscreen filter

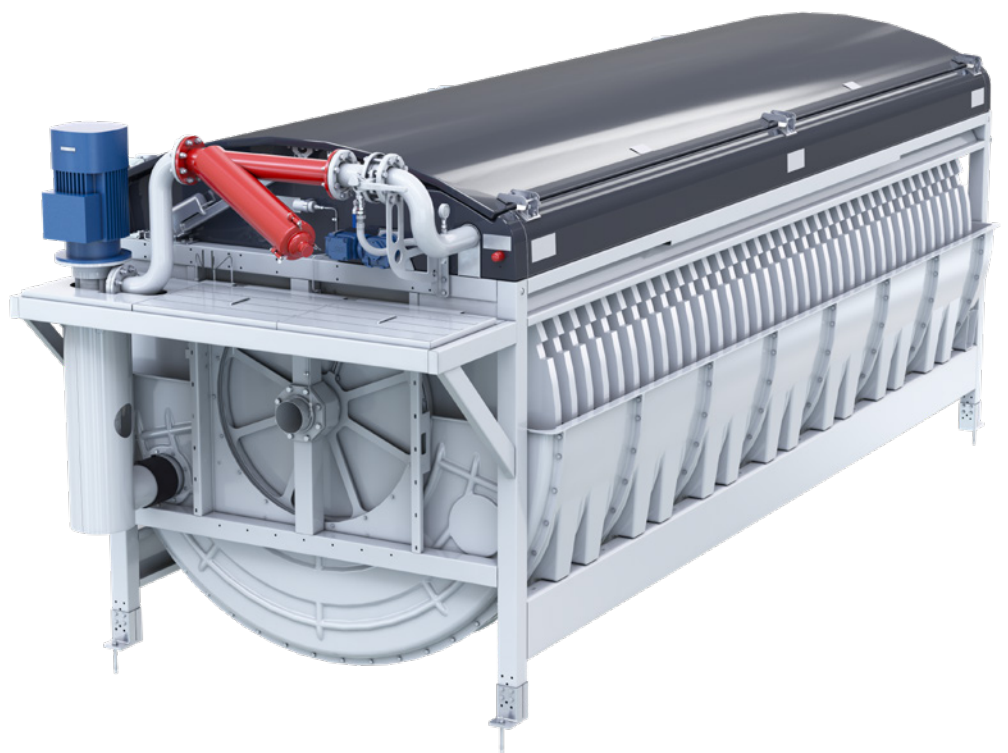

Main industries and applications

The DynaDisc filters deliver superior filtration performance in water and wastewater applications such as raw water screening and wastewater polishing and are part of Nordic® ZeroP applications.

The DynaDisc consists of multiple rotating filter discs and is a well proven system that uses fine woven filter media. This sophisticated design produces a highly effective filtration process that can achieve high filtration efficiencies.

DynaDisc filter is designed for use in applications such as:

- Effluent polishing of wastewater
- Raw water filtration
- Water reuse
- Process water filtration
- Cooling water filtration
- Pre-filtration before sand filters
- Pulp and paper industry
- Aquaculture operations
- Phosphorous removal



Superior design, superior performance

How DynaDisc filter works

The water to be filtered enters into the rotor drum and flows by gravity into the filter discs. The water is filtered through the filter cloth and the suspended solids accumulates on the inside of the filters.

The backwash system starts automatically to clean the filters using the already filtered water to safely remove the suspended solids from the discs and in to the reject trough.

The filter discs are submerged up to 65% and the filtered water is collected in the level tank surrounding the discs. The filtered water gently overflows the edges of the level tank and flows on towards reuse or final discharge.

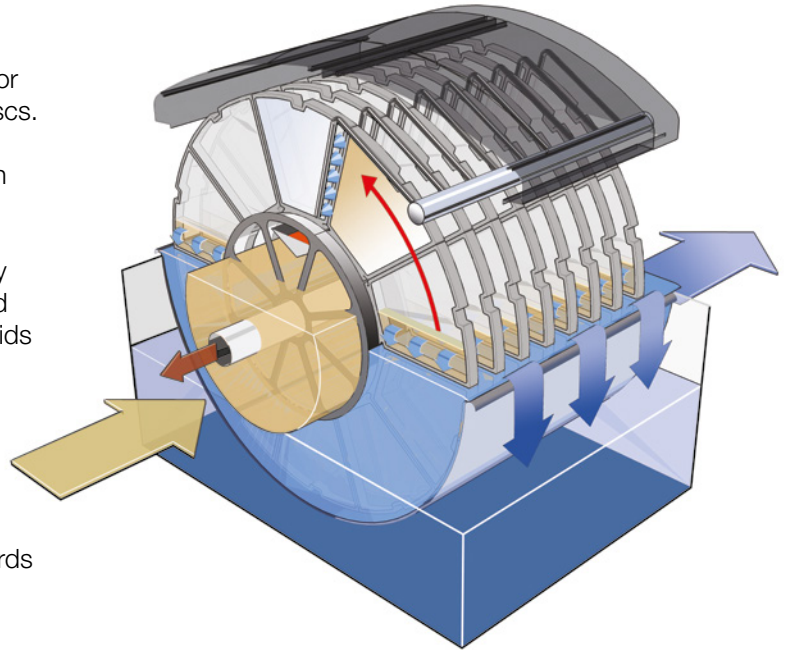

When the water level inside the filter discs increases to a pre-set point, the filter rotor starts rotating and the backwash of the filter cloth starts. The high-pressure backwash spray nozzles remove the accumulated suspended solids into the reject trough inside the filter. The suspended solids are discharged by gravity.

The rotation of the disc filter is driven by a helical-bevel gear drive via a non-corrosive synchronous carbon fibre reinforced cog belt.

High capacity on a small footprint

The DynaDisc filter offers a distinct advantage in filtration applications. The unique design enables professionals in the water and wastewater industries to get maximum reliability day in and day out, year in and year out.

Models – two versions, one method

The DynaDisc filter is available as a freestanding unit with filter discs contained in a stainless-steel tank and another version for installation in a concrete tank.

The two versions have the same design regarding drive system, backwash system, level tank, disc cassettes, etc. The effective filter area can be up to 251 m² per filter on less than 25 m² floor area.

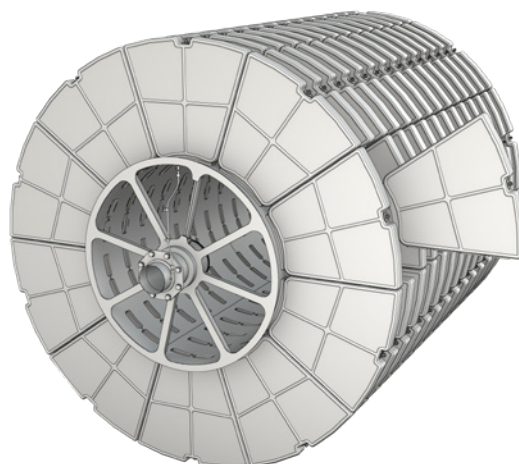
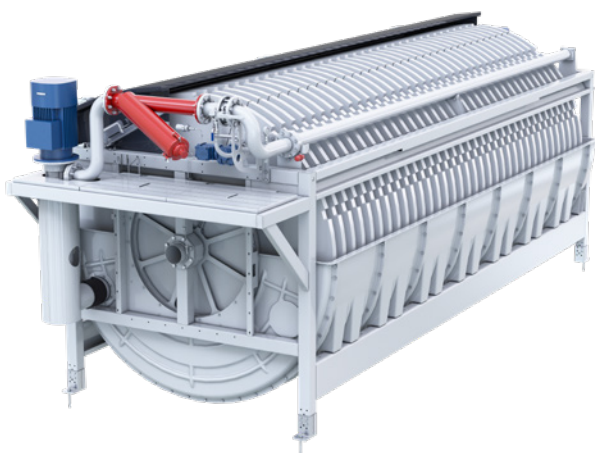

Easy maintenance

The backwash system with oscillating spray nozzles and the integrated level tank are some of the specific design details that make the DynaDisc a reliable filtration unit which requires a minimum of maintenance.

The filter cassettes are easily replaced in least possible down-time. Each disc consists of 8 or 10 filter cassettes. The cassettes are easily removed by loosening a nut. The new cassette is then installed by sliding the cassette over the rod and tightening the nut again.

Features and benefits

1 Patented filter cassette for quick and easy maintenance

- Faster replacement and less weight ensured by the 8 or 10 cassettes per disc
- Low weight allows for up to 45 pcs 2.4 m diameter discs to be installed in one unit, providing up to 251 m² effective filter area

2 Compact and robust design for reliable operation

- Filter cloth bonded directly to the cassette body – reduces the seal length to a minimum to avoid leakage
- Strong cassette body gives long service life as it allows high tension on the filter cloth

3 Integrated level tank for longer lifetime

- An integrated level tank provides a long overflow weir, which controls the head differential and maximizes the filter capacity, gives less tension on the filter cloths and increases their life span
- Residual chemicals after cleaning the filter cloth are collected in the level tank, thus reducing acid corrosion of the concrete

4 Backwash system protects the filter cloth

- To minimize clogging and to protect the filter cloths from grit, the backwash system uses the already filtered water in the level tank
- The slowly oscillating spray nozzles ensure an even and efficient cleaning which also increases the lifetime of the filter cloth

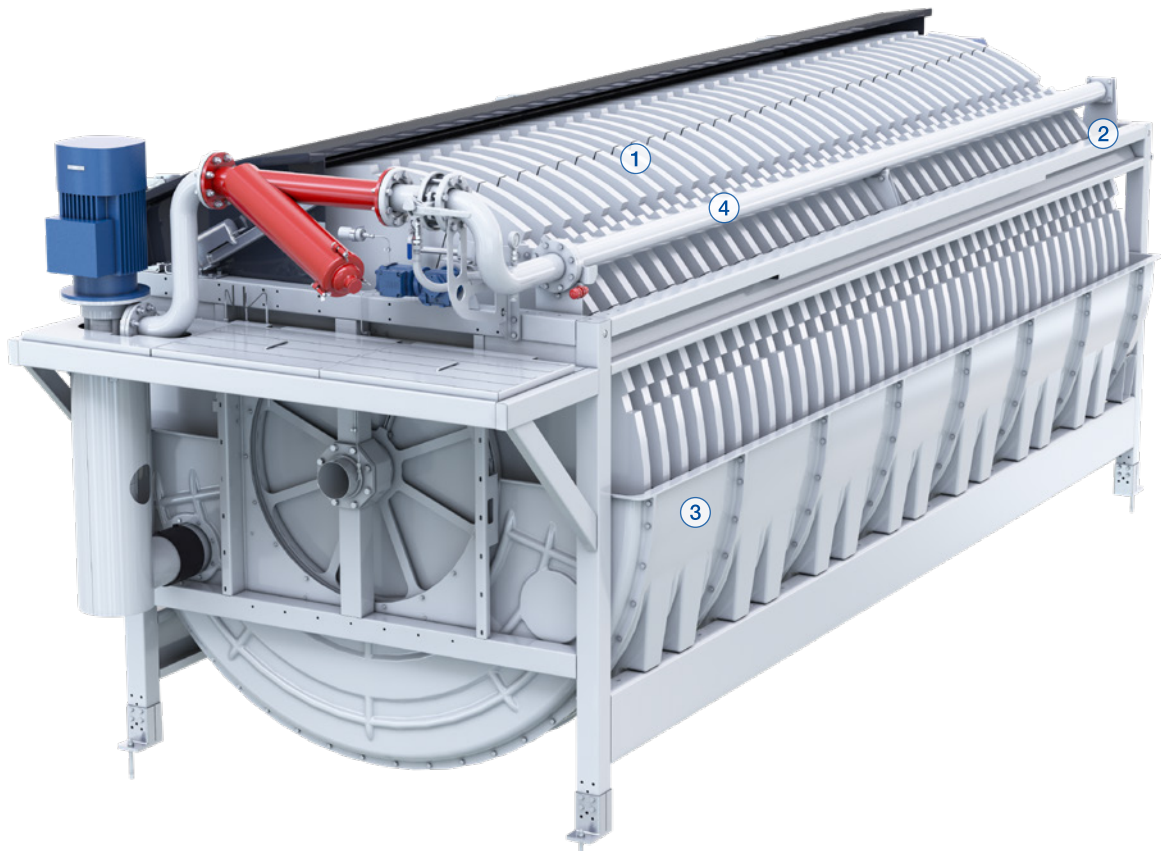

DynaDisc in worldwide applications

Wastewater varies between different sites and conditions. That is why we provide flexible products that offer you plenty of versatility in all areas of a wastewater treatment plant. They are also efficient enough to cope with the challenges of the future as the global population growth, space becomes increasingly scarce and ever-stricter requirements are placed on us to ensure that we can maintain and improve the quality of the world's lakes, seas and rivers.

Our DynaDiscs have provided users with compact, efficient and reliable filtration worldwide in many different types of applications since 1996. The DynaDisc contributes to improved environmental quality and enable potential reuse of treated wastewater, which helps to secure future high-quality fresh water.

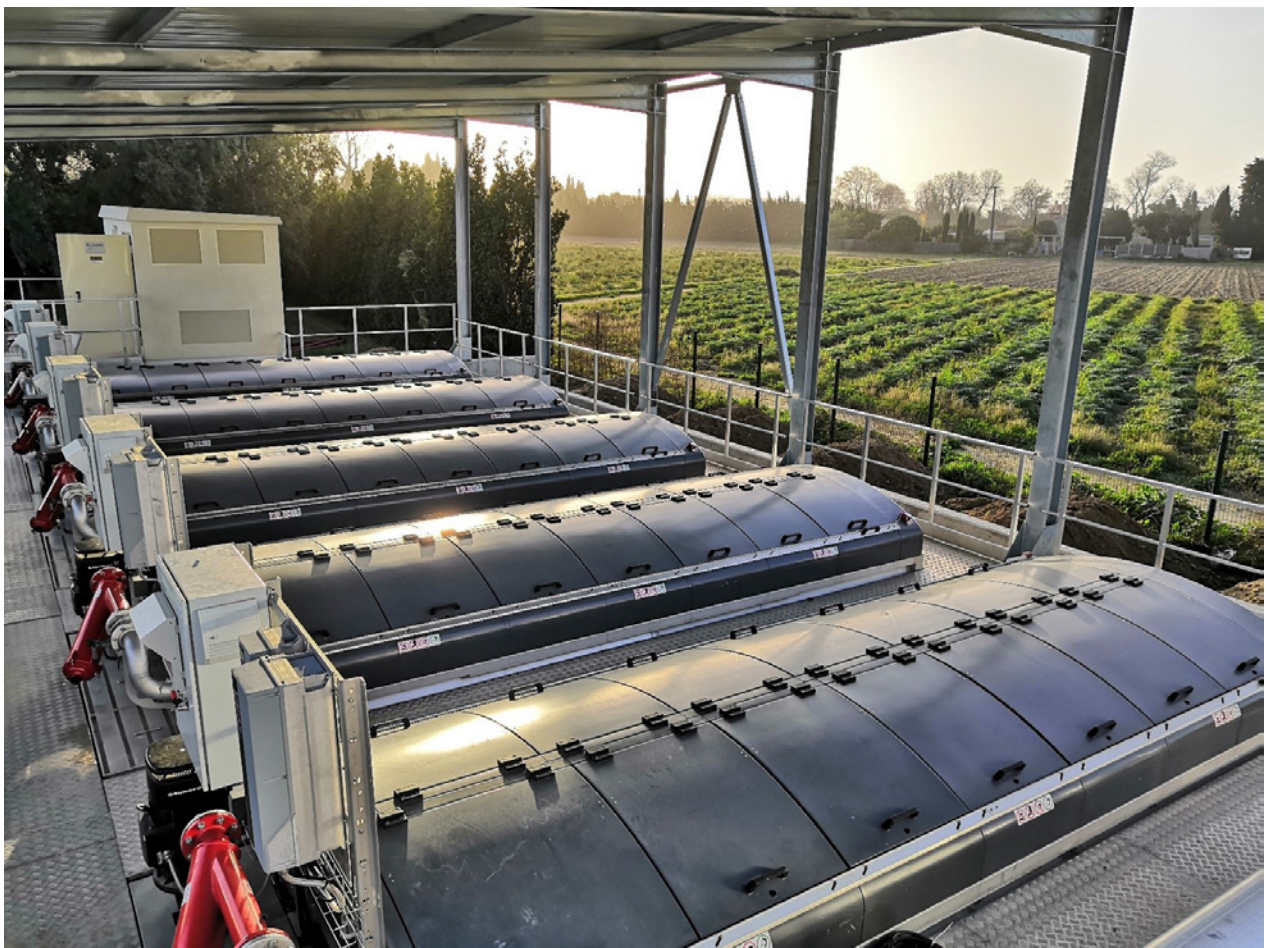

Complete systems streamlined operations

We fulfill the demands from municipalities and industrial facilities requiring complete water and wastewater package solutions.

Our proven system configurations meet the strict requirements and increase water recovery. They minimize the need to use resources for detailed planning and implementation costs.

Nordic® ZeroP

We offer several products used in tertiary treatment stages proven to keep outlet phosphorus levels less than 0.1 mg/l. The products are based on efficient usage of chemical precipitation and are one of the most cost/energy effective and reliable method available for municipal wastewater treatment plants.

- Deep-bed filtration using DynaSand filter
- Pile cloth filtration using DynaCloth or
- Surface filtration using DynaDisc

The use of mechanical final processing of outflowing water from the treatment process is a highly effective way of removing any phosphorus bound to particles. To achieve extremely low phosphorus levels, the dissolved phosphorus also needs to be separated, which is done through a process of using aluminum or iron salts as precipitants. The total phosphorus output levels can then be controlled based on the metal salt dosage.

DynaDisc surface filtration will give you the smallest overall footprint and lowest investment costs. This system often shows low phosphorus while giving extremely low levels of wash water. The height of the units as well as the head-loss over the DynaDisc filters are very low which means it is easy to gravitate flows without pumping as a final treatment stage without excavations. Even if you select a filter system based upon DynaSand, DynaCloth or DynaDisc you will get the most reliable method available for keeping the phosphorus levels down to a minimum.

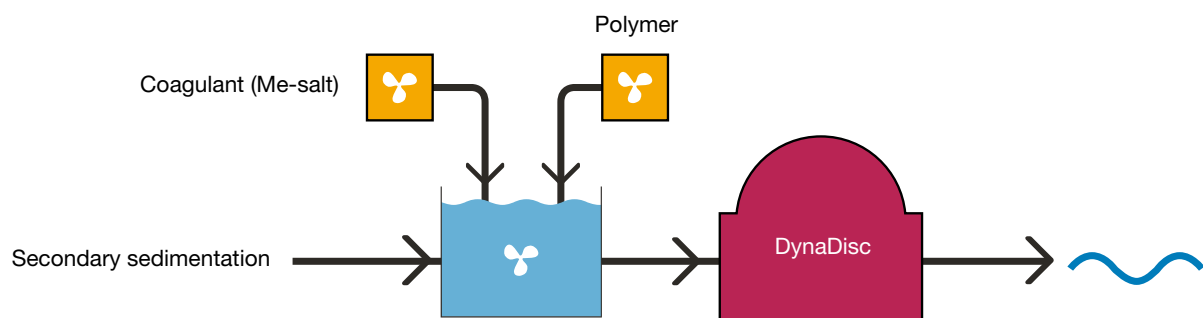

Example of flowchart for Nordic® ZeroP

The Sulzer Flow division keeps your processes flowing. Wherever fluids are treated, pumped, or mixed, we deliver highly innovative and reliable solutions for the most demanding applications.

The Flow division specializes in pumping solutions specifically engineered for the processes of our customers. We provide pumps, agitators, compressors, grinders, screens and filters developed through intensive research and development in fluid dynamics and advanced materials. We are a market leader in pumping solutions for water, oil and gas, power, chemicals and most industrial segments.

E10791 en 9.2024, Copyright © Sulzer Ltd 2024

This brochure is a general presentation. It does not provide any warranty or guarantee of any kind. Please, contact us for a description of the warranties and guarantees offered with our products. Directions for use and safety will be given separately. All information herein is subject to change without notice.

