

# SULZER

## Your partner for offshore floating production

Sulzer is a world leader in the energy industry. We provide state-of-the-art pumping solutions for oil and gas production, transportation, refining, and petrochemical processing. [sulzer.com/upstream](https://www.sulzer.com/upstream)

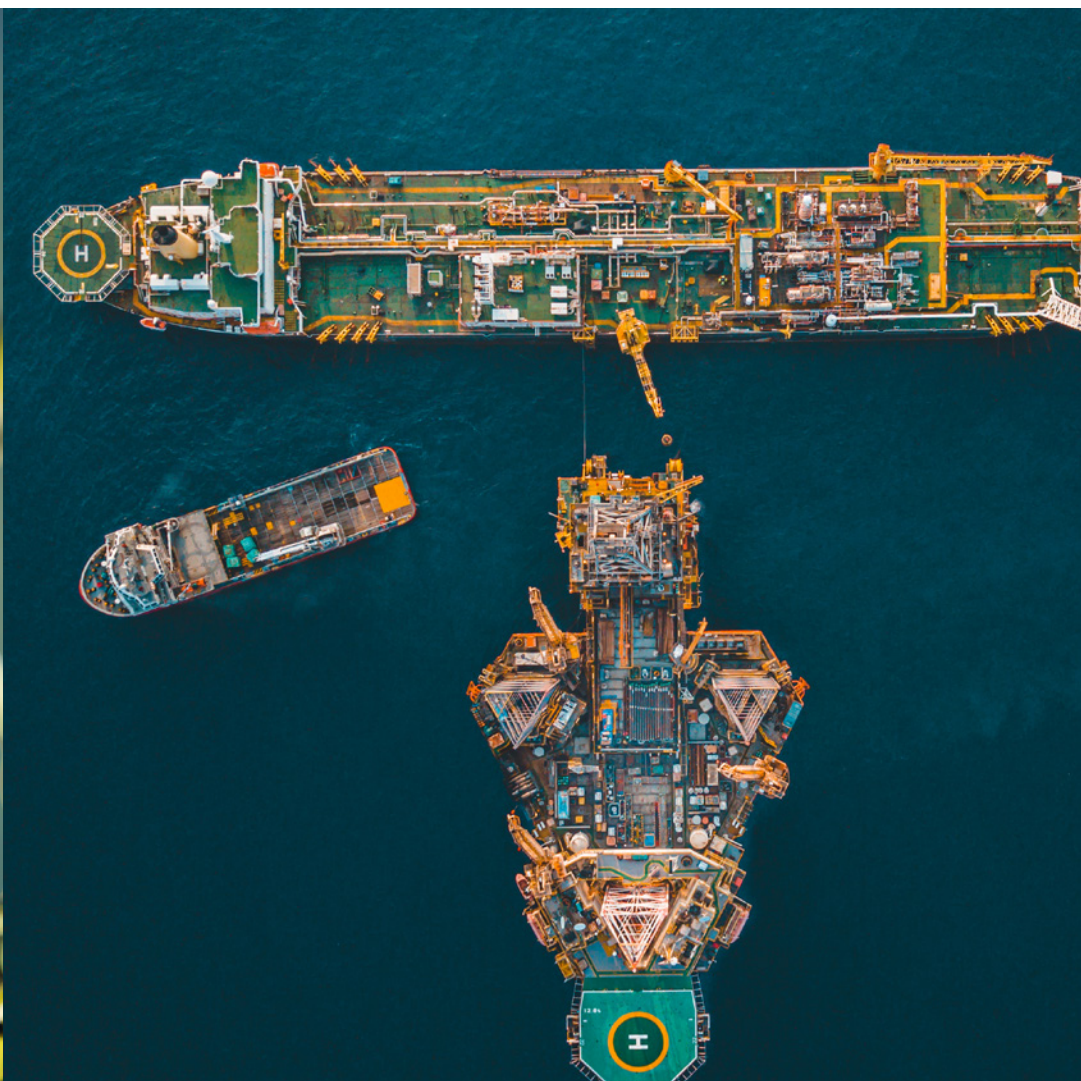

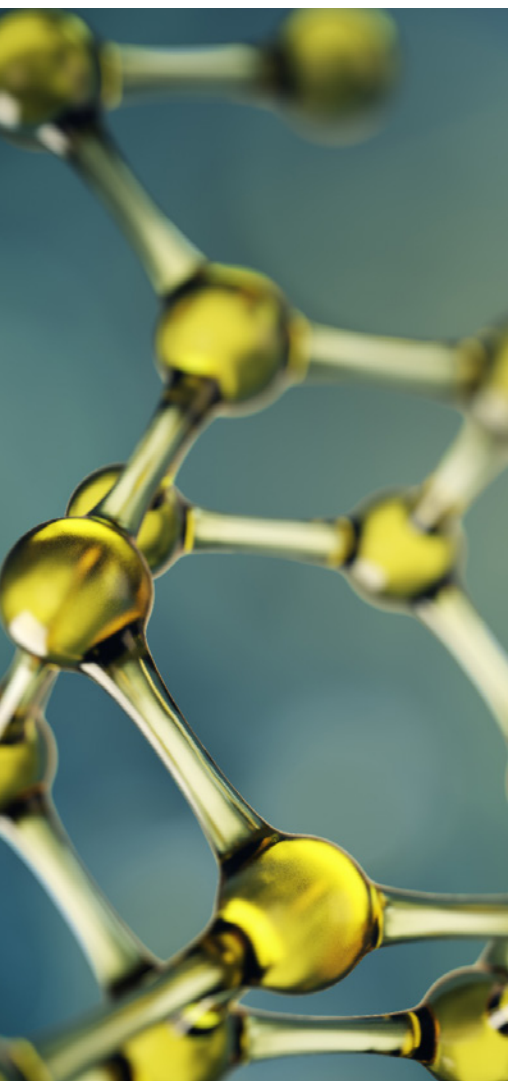

# Decades of world records in oil and gas

---

1975	World's first duplex injection pumps	Algeria – 13 units
1977	World's largest injection pumps	15.7 MW – 2 units
1978	World's largest crude oil pipeline	Saudi Arabia – 33 units
1978	World's largest oil pipeline pumps	Saudi Arabia 11.2 MW – 33 units
1981	World's largest injection pumps	Alaska – 18.8 MW – 2 units
1984	World's largest offshore injection pump	Abu Dhabi – 14.2 MW – 1 unit
1985	World's longest pipeline	Canada – 100 units
1992	World's largest vertical injection pumps	Norway – 6.7 MW – 2 units
1994	World's largest LNG send out pumps	Turkey – 2,121 m – 5 units
1999	World's largest offshore multiphase pumps	North Sea – 4.5 MW – 2 units
2000	World's largest multiphase pumps	Siberia – 6.0 MW – 4 units
2001	World's highest pressure injection pumps	Gulf of Mexico – 605 bar – 4 units
2002	World's largest injection pumps	Caspian Sea – 27 MW – 4 units
2007	World's largest LNG send out pumps	Belgium – 1.43 MW – 3 units
2008	World's largest oil pipeline pumps	Russia – 14.5 MW – 24 units
2011	World's highest pressure injection pump	Gulf of Mexico – 800 bar – 2 units
2012	World's highest power subsea multiphase pump	3.2 MW – 1 unit
2020	World's highest pressure injection pump	Gulf of Mexico – 1'000 bar – 2 units





# The Sulzer advantage

---

## Expertise

Sulzer has extensive knowledge in the oil and gas market. Our highly skilled engineers have an excellent track record in implementing effective solutions to meet the needs for increased pressures and flow rates in the offshore floating production field.

## Reliability

With the increases in remote and under-developed production locations, pump reliability is vital to the success of projects.

Sulzer's pumps have a reputation for being reliable in the most challenging of locations which makes us the right partner for offshore floating production projects.

## Customer service

Our engineers work closely with each customer to ensure their pumps meet the specific needs of the project.

Sulzer supports the customer as a sole-source supplier with a vast range of products and a global network of service centers.

## State-of-the-art testing capabilities

All Sulzer manufacturing plants have advanced testing facilities, capable of demonstrating pump performance and proving the ancillary equipment to ensure smooth commissioning and start-up.

## Gas turbine string testing

One of the Sulzer differences is our unique in-house gas turbine string test facility in Leeds, UK. Having supplied hundreds of gas turbine driven pumps, we are aware of the need to run the full train prior to shipment. The GT test facility in Leeds can string test with gas turbines up to 30 MW. The other test loops in Leeds can test to even higher MW using motors and Variable Frequency Drive (VFD). Our other facilities have similar variety of test facilities to test pumps they build.

## Subsea testing

Sulzer, together with FMC technologies, a leading provider of subsea production and processing systems, have developed a powerful new subsea multiphase pressure boosting system. These systems combine field proven pump hydraulics from Sulzer and both permanent magnet motor technology and world leading subsea processing system integration from FMC technologies.

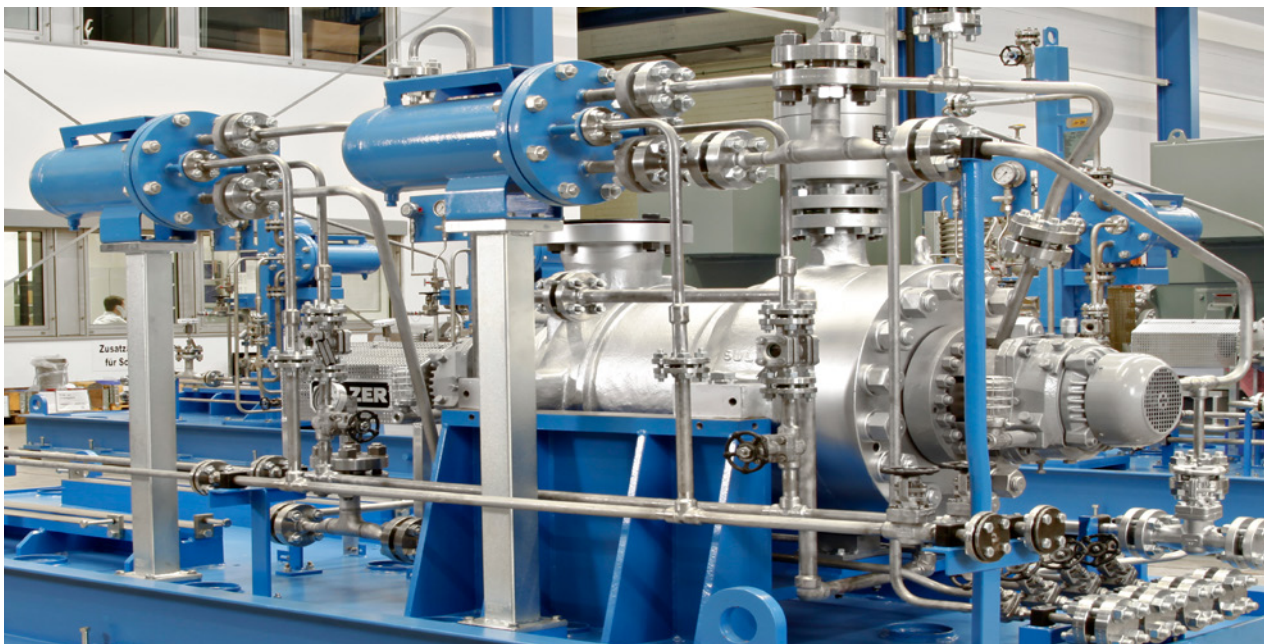

# You set out the challenge, we have the solution

## Oil production

Pumps for injection, main oil line, seawater lift, fire-fighting, subsea and associated auxiliary applications

## Floating Production, Storage and Offloading (FPSO)

Pumps for injection, firewater, seawater lift, offloading, process and auxiliary

## Pipelines

Booster pumps and main line pipeline pumps for upstream and mid-stream applications: crude oil, diluted bitumen, diluent, Natural Gas Liquids (NGL), refinery products and petro-chemicals (gasoline, diesel, Liquefied Petroleum Gas (LPG), super critical ethylene, etc.)

## Gas (LNG)

Ultra-high pressure send out pumps for the latest generation of LNG terminals

## CO2

CO2 pipeline transportation and high pressure injection pumps

## Pump services

Diagnostic and consulting, maintenance and support, technical and economic optimization through retrofits

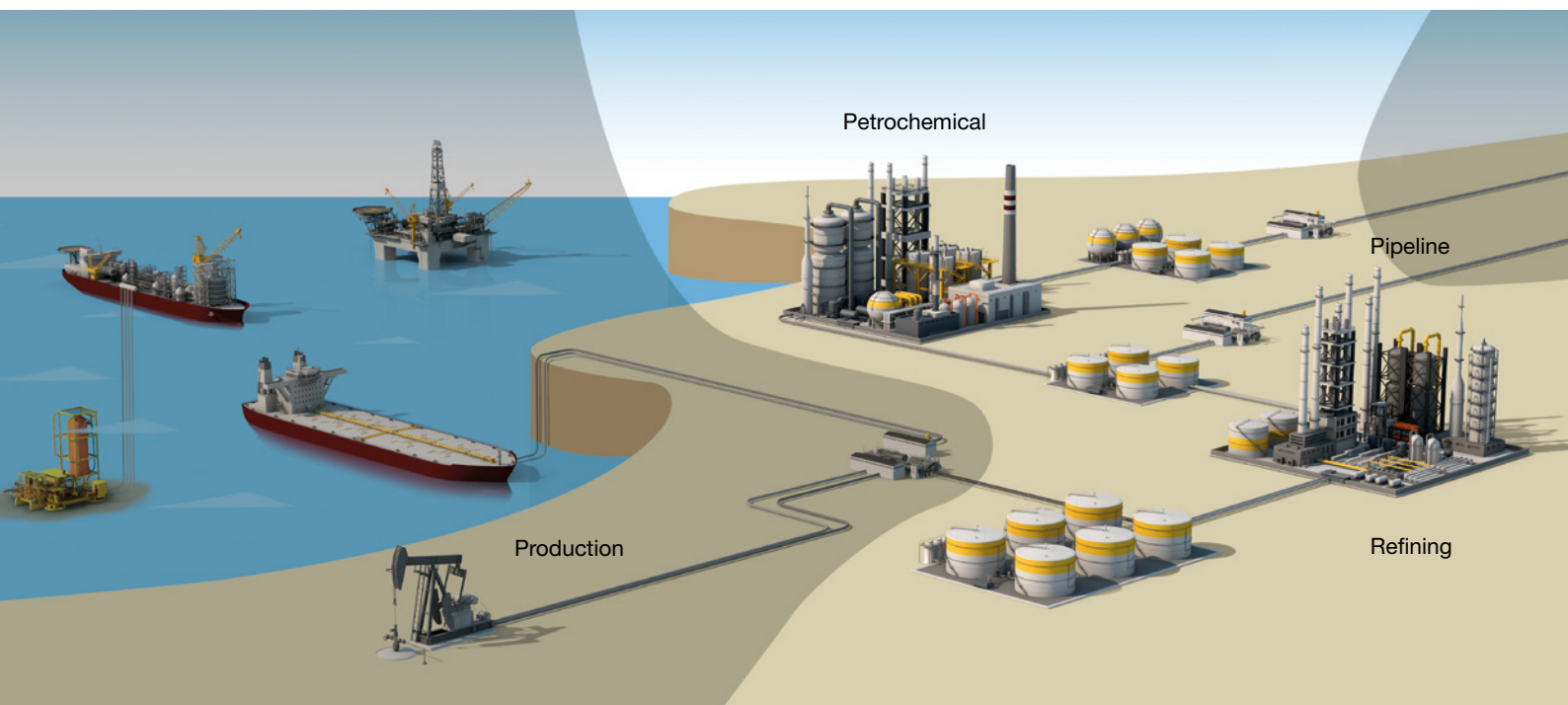

# A solution for every application

---

## **Water injection**

Reliable water injection is critical to modern oil production processes and is dependent upon efficient pumps that can operate for extended periods before needing maintenance. As the search for oil leads to the development of ever more extreme fields in terms of depth or geographical remoteness, the pumps selected become critical to the fields' practical operation and viability. Sulzer manufactures four pump ranges specifically tailored for injection applications. Re-injecting produced water is an extremely abrasive application and would be detrimental to a pump's performance, which can be evident in as early as a few weeks. Sulzer has developed coating technology that will greatly extend the pump life. Sulzer Pumps reputation is second to none for delivering ground breaking designs that keep the 'state of the art' ahead of the demands of these new developments.

## **Firewater systems**

Firewater pumps lie at the heart of a FPSO firefighting system. The ability to run reliably under extreme conditions for extended periods of time is a key customer requirement. Sulzer's self contained hydraulic drive fire pump system delivers optimal firefighting performance coupled with features to ensure minimum maintenance is required during long periods on standby. Conventional shaft drive fire sets are also available. Both options are fully packaged and tested by Sulzer to meet exacting customer needs.

## **Seawater lift**

Provision of seawater for cooling and other service requirements demand efficient, compact pumping solutions. Sulzer's range of vertical axially split pumps are ideally suited to this application. Mounted inside the hull and taking suction from the sea chest, their compact dimensions minimize space. For seawater lift pumps specified mounted inside a caisson, Sulzer is able to provide vertical solutions with electro-submersible motor and traditional line-shaft.

## **Crude oil off-loading**

Depending on the FPSO design, a booster pump is often required to export crude oil delivered to deck level by the FPSO cargo system. These pumps need to take the available output from the cargo pumps and boost it to sufficient pressure to allow transportation to an offloading tanker or pipeline to shore. Through utilization of expertise gained in years of experience in designing pumps for transcontinental pipelines, Sulzer produces engineered solutions specifically tailored to individual customer requirements.

## **Flow assurance**

Sulzer BB3 and BB5 pumps are also used for flow assurance service – sometimes referenced as dead oil or hot oil circulation. Though they are usually electric motor driven, sometimes they are specified with diesel engine drivers. These pumps are critical to maintain oil production in cold deep water.

## **Seawater treatment**

Enhanced oil recovery methods mean that prior to injection Sea Water will be treated to remove or reduce salt content. Sulzer pumps are employed to deliver sea water to the RO membrane rack to achieve this. Configuration of the sea water treatment module will determine which pump type is selected. BB2 pumps are usually designated for this application; however, multistage BB3 and BB5 pumps will be specified when higher pressure is required at the membrane.

## **Process and auxiliary systems**

The complex processes performed on a typical FPSO rely on the performance of dozens of pumps handling a variety of liquids under widely varying process conditions. The pumps are available in full compliance with the latest API610 and ANSI standards as well as designed for general industrial applications. Whatever the process or auxiliary application, Sulzer has a selection optimized to deliver economic, reliable performance.

# Offshore floating production

The complex processes performed on a typical FPSO rely on the performance of dozens of pumps handling a variety of liquids under widely varying process conditions. Sulzer offers pumps in full compliance with the latest API610 and ANSI standards as well as pumps designed for general industrial applications.

Whatever the process or auxiliary application, Sulzer has a selection optimized to deliver economic and reliable performance for:

- Water injection
- Firewater systems
- Seawater lift
- Crude oil off-loading
- Flow assurance
- Seawater treatment
- Process and auxiliary systems

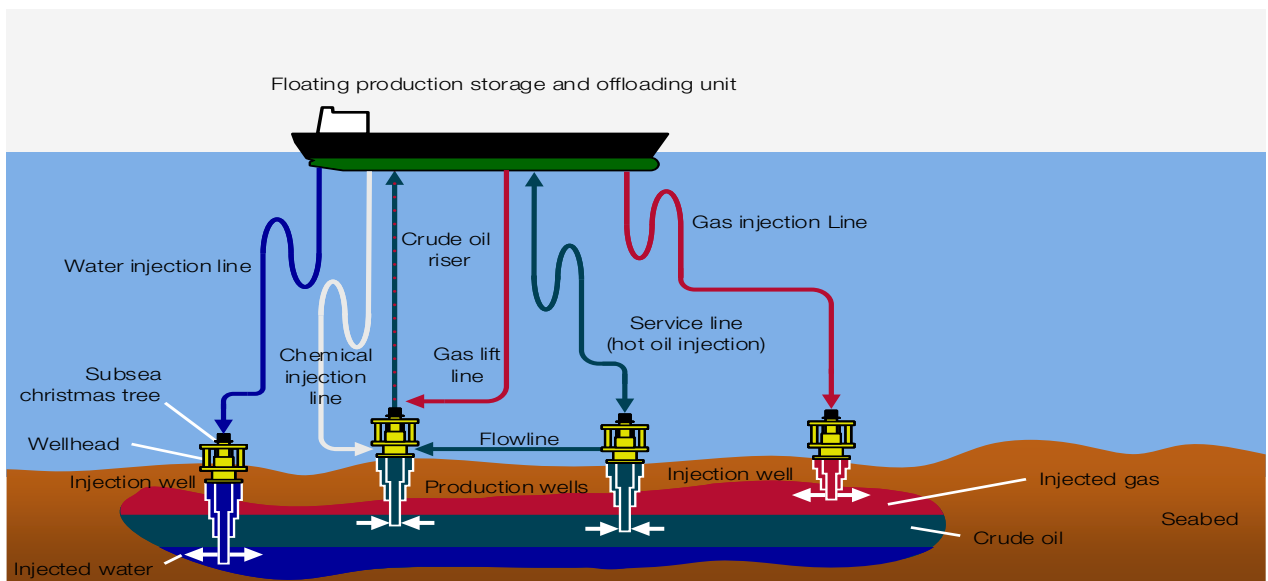





---

### **Floating Liquefied Natural Gas (FLNG)**

Floating above an offshore natural gas field, the FLNG facility will produce, liquefy, store and transfer natural gas (LNG) at sea before carriers ship it directly to markets.



---

### **Floating Production Unit (FPU)**

Floating production units will usually be barge shape or platform type semi-submersible. As the name implies, these units have limited or no storage capacity.



---

### **Floating Storage and Off-loading (FSO)**

A vessel used only to store oil without processing it is referred to as a floating storage and offloading vessel (FSO).



---

### **Semi-submersible floating platform**

A semi-submersible is a specialized marine vessel with good stability and seakeeping characteristics. The semi-submersible vessel design is commonly used in a number of specific offshore roles such as for offshore drilling rigs, safety vessels, oil production platforms and heavy lift cranes.



---

### **Tension Leg Platform (TLP)**

A TLP is a floating platform suitable for deepwater oil and gas field development. The platform is moored to the seabed by high tensile strength steel tubes which allow very little vertical motion.



---

### **SPAR**

A SPAR platform is a type of floating oil platform typically used in very deep waters. SPAR production platforms have been developed as an alternative to conventional platforms.







# Meeting your most demanding needs

	Application					
	Floating Production, Storage and Offloading (FPSO)	Floating Production Unit (FPU)	Floating Storage and Off-Loading (FSO)	Semi-Submersible Floating Platform	Tension Leg Platform (TLP)	SPAR
Water injection	HPcp GSG CP MSD	HPcp GSG CP MSD		HPcp GSG CP MSD	HPcp GSG CP MSD	HPcp GSG CP MSD
Firewater systems	D-H FWP D-E FWP	D-H FWP D-E FWP	D-H FWP D-E FWP	D-H FWP D-E FWP	D-H FWP D-E FWP	D-H FWP D-E FWP
Seawater lift	SJS SJT SMHv	SJS SJT SMHv		SJS SJT	SJS SJT	SJS SJT
Crude oil off-loading	MSD HSB HSA	MSD HSB HSA	MSD HSB HSA	MSD HSB HSA	MSD HSB HSA	MSD HSB HSA
Seawater treatment	BBTD BBS	BBTD BBS		BBTD BBS	BBTD BBS	BBTD BBS
Flow assurance (dead oil / hot oil)	MSD CP GSG	MSD CP GSG		MSD CP GSG	MSD CP GSG	MSD CP GSG
Process and auxiliary systems	OHH/PRE OHV BBS CPE	OHH/PRE OHV BBS CPE	OHH/PRE OHV CPE	OHH/PRE OHV BBS CPE	OHH/PRE OHV BBS CPE	OHH/PRE OHV BBS CPE

# Product overview

## OH1

### CPE ANSI process pumps range ANSI / ASME B73.1 OH1

#### Features and benefits

- Maximized reliability thanks to shaft sealing conditions and heavy-duty bearing unit
- High standardization, easy installation and robust construction equate to reduced maintenance and operating costs

#### Applications

- Viscous liquids, clean and slightly contaminated liquids, fibrous slurries

#### Key characteristics

Capacities	up to 1'650 m <sup>3</sup> /h / 7'000 USgpm
Heads	up to 275 m / 900 ft.
Pressures	27.5 bar / 400 psi
Temperatures	up to 260°C / 500°F

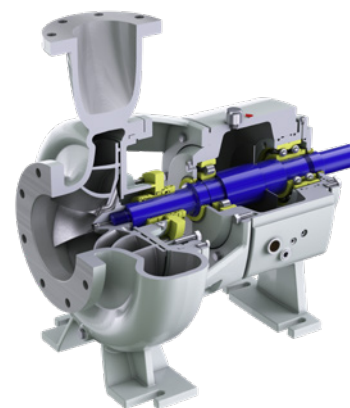

## OH2

### OHH/PRE overhung single stage pump API 610 OH2

#### Features and benefits

- Broadest range coverage in the industry for API 610 type OH2 pumps
- Finned bearing housing and fan cooling for long bearing life
- Bearing lubrication designed for vessel pitch and roll
- Low flow Barske type impeller variants available
- High suction pressure design (PRER) available
- Available in special alloys for corrosive service

#### Applications

- Process and boosting applications

#### Key characteristics

Capacities	up to 2'250 m <sup>3</sup> /h / 10'000 USgpm
Heads	up to 400 m / 1'500 ft.
Standard design pressures	up to 76.5 bar / 1'110 psi
High pressure design	up to 150 bar / 2'200 psi
Temperatures	up to 425°C / 800°F

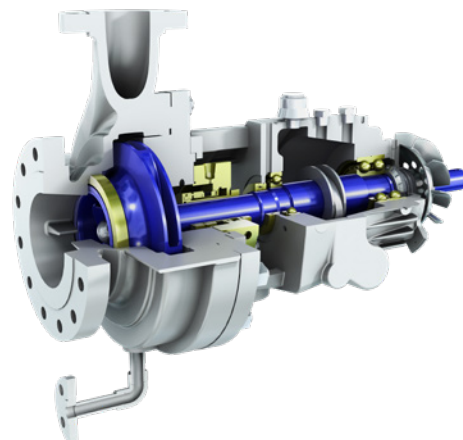

## OH3

### OHV/OHVL overhung vertical inline pump API 610 OH3

#### Features and benefits

- Finned bearing housing and fan cooling for long bearing life
- Broadest range map in the industry for ISO 13709 (API 610) type OH3 pumps
- Heavy duty baseplates with 2x ISO 13709 (API 610) nozzle load option
- ISO 21049 (API 682) cartridge type mechanical seals for reduced emissions
- Electric motor, VFD, engine and steam turbine drivers

#### Applications

- Process and boosting applications

#### Key characteristics

Capacities	up to 1'450 m <sup>3</sup> /h / 6'800 USgpm
Heads	up to 350 m / 1'150 ft.
Pressures	up to 51 bar / 740 psi
Temperatures	-160 to 340°C / -256 to 650°F

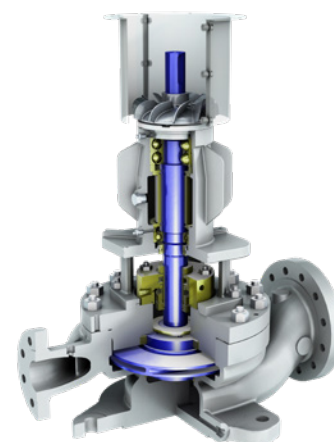



## BB1

---

### HSB horizontal axially split single stage between bearing pump API 610 BB1

#### Features and benefits

- Staggered vane, double suction impeller on larger sizes for reduced vibration
- Custom hydraulics to meet both current and future requirements with a simple rotor / volute changes
- Ball-ball, sleeve-ball and sleeve-pivot shoe bearings are available
- High-speed designs available for remote gas turbine-driven applications

#### Applications

- Crude oil pipelines
- Heavy duty auxiliary applications

#### Key characteristics

Capacities	up to 10'000 m <sup>3</sup> /h / 45'000 USgpm
Heads	up to 550 m / 1'800 ft.
Pressures	up to 150 bar / 2'200 psi
Temperatures	up to 205°C / 400°F

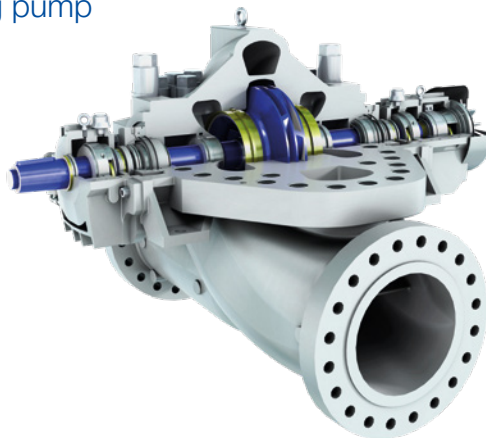

### HSA/SMH axially-split single stage pump API 610 BB1

#### Features and benefits

- Between bearing design for reliability at high flow rates
- Broad hydraulic coverage at 50 and 60 Hz speeds
- Axially split casing for ease of repair
- Vertical shaft (HSAv/SMHv) for limited deck space applications

#### Applications

- Onshore cooling water
- Offshore seawater
- FPSO

#### Key characteristics

Capacities	up to 11'000 m <sup>3</sup> /h / 50'000 USgpm
Heads	up to 260 m / 800 ft.
Pressures	15 to 40 bar / up to 560 psi
Temperatures	up to 150°C / 300°F

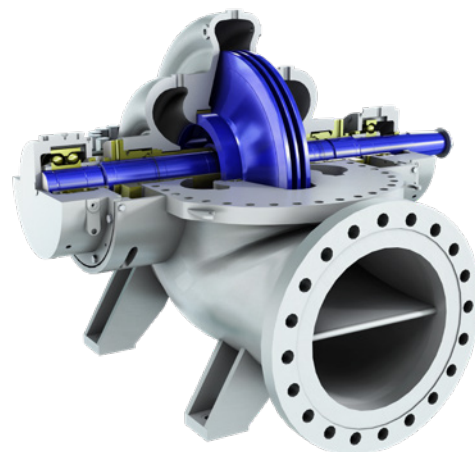

### HSAv/SMHv vertically mounted axially-split single stage pump API 610 BB1

#### Features and benefits

- With grease lubricated thrust bearing at the drive end and product lubricated proven design bearing at the non-drive end
- Interchangeable casing with the horizontal arrangement

#### Applications

- Seawater lift
- Ballast water

#### Key characteristics

Capacities	up to 11'000 m <sup>3</sup> /h / 50'000 USgpm
Heads	up to 260 m / 800 ft.
Pressures	15 to 40 bar / up to 560 psi
Temperatures	up to 150°C / 300°F

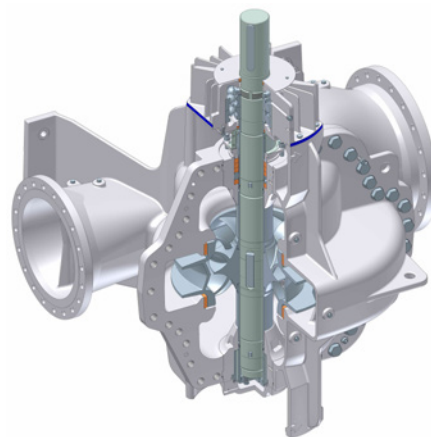

## BB2

### BBS and CD between bearings single stage pump API 610 BB2

#### Features and benefits

- Centerline support for reduced thermally induced misalignment
- Double suction impeller for low NPSH3
- First critical speed is well above operating speed range for smooth operation
- Casing designed for 2 times API 610 nozzle loads for freedom from piping distortions
- Grouted or ungrouted, 1x or 2x nozzle load baseplates for reduced installation cost

#### Applications

- Booster as well as high speed crude shipping services
- Sulfate removal

#### Key characteristics

Capacities	up to 5'000 m <sup>3</sup> /h / 22'000 USgpm
Heads	up to 450 m / 1'500 ft.
Pressures	up to 50 bar / 740 psi
Temperatures	up to 425°C / 800°F

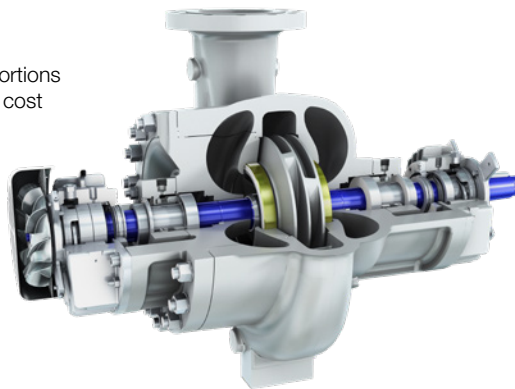

### BBT/BBTD radially split two stage pumps API 610 BB2

#### Features and benefits

- Centerline support for reduced thermally induced misalignment
- BBT-D double-suction impeller for low Net Positive Suction Head (NPSH)
- First critical speed is well above operating speed range for smooth operation
- Casing designed for 2x API 610 nozzle loads for freedom from piping distortions
- Grouted or ungrouted, 1x or 2x nozzle load baseplates for reduced installation cost

#### Applications

- Seawater and crude oil boosting applications

#### Key characteristics

Capacities	up to 2'000 m <sup>3</sup> /h / 10'000 USgpm
Heads	up to 740 m / 2'500 ft.
Pressures	up to 100 bar / 1'480 psi
Temperatures	up to 425°C / 800°F

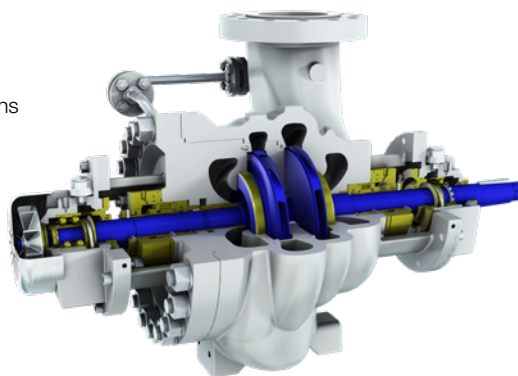

## BB3

### MSD axially split multistage pumps API 610 type BB3

#### Features and benefits

- Broadest hydraulic coverage of any BB3 type multistage pump in the market
- Axially split casing means rotor balance is not disturbed when rotor is installed
- Opposed impellers balance axial thrust, saving lube system costs on most applications
- Double suction, first-stage available on most sizes for reduced Net Positive Suction Head (NPSH)
- High speed option for gas turbine drive

#### Applications

- Pipelines
- Water injection
- CO2 pipeline and injection

#### Key characteristics

Capacities	up to 3'200 m <sup>3</sup> /h / 14'000 USgpm
Heads	up to 2'900 m / 9'500 ft.
Pressures	up to 300 bar / 4'400 psi
Temperatures	up to 200°C / 400°F

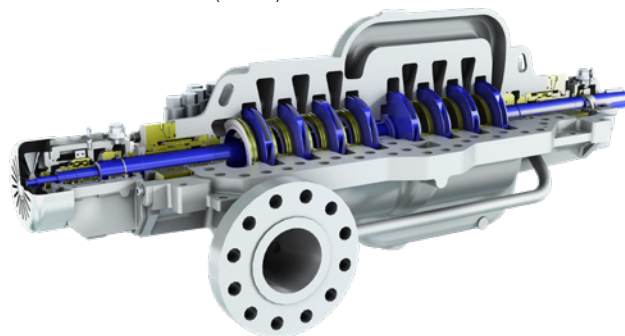



## BB5

### CP volute style barrel pump API 610 BB5

#### Features and benefits

- Opposed impellers balance axial thrust, with no lube system needed on smaller pumps
- Axially split inner case means rotor balance is not disturbed when installed in the pump
- Dual volute inner case balances radial loads for longer service life
- Twist lock barrel closure reduces maintenance time on lower temperature services
- Cartridge design on larger pumps can speed up pump repair time
- Volute inner case with lower erosion wear on abrasive services

#### Applications

- High pressure oil transport
- Onshore water injection
- Offshore crude oil shipping
- LPG pipelines

#### Key characteristics

Capacities	up to 1'000 m <sup>3</sup> /h / 4'400 USgpm
Heads	up to 7'000 m / 23'000 ft.
Pressures	up to 425 bar / 6'250 psi
Temperatures	up to 425°C / 800°F

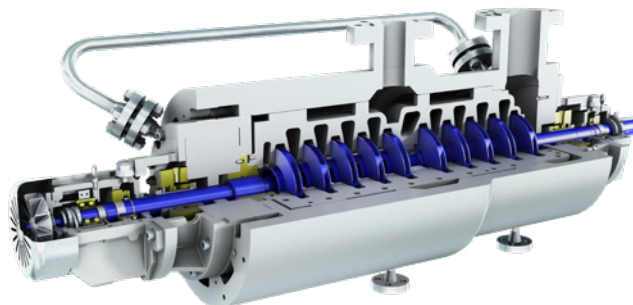

### GSG diffuser style barrel pump API 610 BB5

#### Features and benefits

- Least costly form of ISO 13709 / API 610 Type BB5 high-pressure barrel pumps
- Low-pressure, high-pressure, twistlock, and high-temperature designs suit many applications
- Direct drive options to 6 MW
- Back-to-back rotor stack allows up to 16 stages on low-density fluids
- Multiple sizes cover a broad hydraulic range

#### Applications

- Onshore or offshore water injection
- Offshore crude oil shipping
- LPG pipelines

#### Key characteristics

Capacities	up to 900 m <sup>3</sup> /h / 4'600 USgpm
Heads	up to 2'600 m / 10'000 ft.
Pressures	up to 300 bar / 4'500 psi
Temperatures	up to 425°C / 800°F

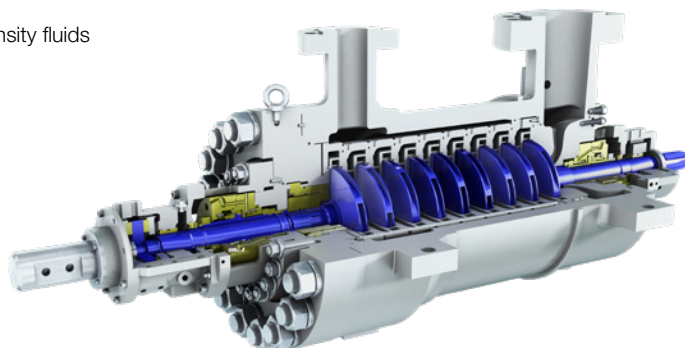

### HPcp diffuser style high energy pump API 610 BB5

#### Features and benefits

- Inline or back-to-back rotor stack designs for rotordynamic stability
- Forged carbon steel, duplex SS, HIP'd and overlaid barrel construction
- Twist Lock or bolted barrel closure with Superbolts™
- Sleeve, pocketed, or tilt pad bearings
- Grouted, ungrouted and offshore 3- or 4-point support baseplates

#### Applications

- Water injection
- Offshore crude oil shipping
- Remote pipeline services

#### Key characteristics

Capacities	up to 4'500 m <sup>3</sup> /h / 20'000 USgpm
Heads	up to 8'000 m / 26'300 ft.
Pressures	up to 1'100 bar / 16'000 psi
Temperatures	up to 200°C / 400°F

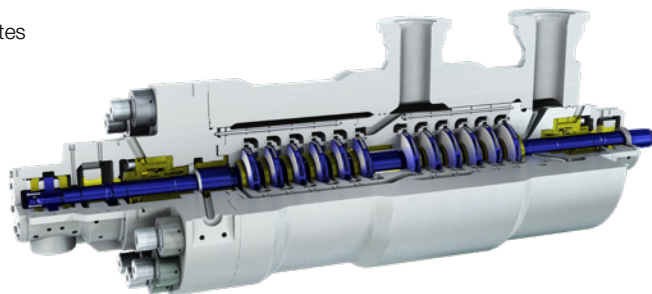

## VS0

### SJS submersible VS0

#### Features and benefits

- No lineshaft couplings or bearings to maintain
- Low, medium and high voltage submersible motors available to 2 MW (2,700 hp)
- Water/glycol filled environmentally friendly motor for improved efficiency
- Variety of materials available from stainless steel to super duplex steel
- Two configurations available: standard (motor below pump) and inverted for low NPSHa applications (pump below motor)

#### Applications

- Offshore seawater lift
- Offshore diesel genset firewater
- Offshore ballast water
- Onshore pressure boosting

#### Key characteristics

Capacities	up to 10'000 m <sup>3</sup> /h / 44'000 USgpm
Heads	up to 230m / 750 ft.
Pressures	up to 40 bar / 600 psi
Temperatures	up to 80°C / 180°F





## Fire fighting systems

---

### SJT vertical turbine pump VS1

#### Features and benefits

- Optimized hydraulics for high efficiency
- Packed stuffing box for reliable sealing and simple maintenance, mechanical seal is optional
- Rubber-lined product-lubricated bearing in bowls and columns for long maintenance-free periods, other bearing materials are also available
- Spacer coupling allows servicing of the seal and thrust bearing as required
- Full pull-out design available for semi-open impellers and bowl diameter sizes > 50" to ease dismantling and maintenance

#### Applications

- Cooling water circulation
- Water supply
- Booster service
- Offshore firewater and service water

#### Key characteristics

Capacities	up to 62'000 m <sup>3</sup> /h / 270'000 USgpm
Heads	up to 110 m per stage / 350 ft. per stage
Pressures	up to 64 bar / 930 psi
Temperatures	up to 50°C / 122°F

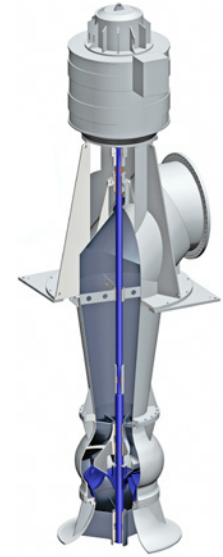

---

### Diesel hydraulic driven pumping unit for firefighting

#### Features and benefits

- Self-contained, containerized or skid module supports a diesel drive, booster pump, hydraulic power unit or angular gear box and lineshaft, fuel system, and all other systems required to operate the unit
- Minimum maintenance is required even during long periods on standby
- Available as container based and as open skid, and in duplex and super-duplex stainless steels
- Extremely robust

#### Applications

- FPSO
- Production platforms
- Drill ships

#### Key characteristics

Capacities	500 to 3'500 m <sup>3</sup> /h / 2'200 to 15'500 USgpm
Heads	up to 200 m / 650 ft.
Pressures	up to 25 bar / 360 psi
Temperatures	up to 50°C / 122°F

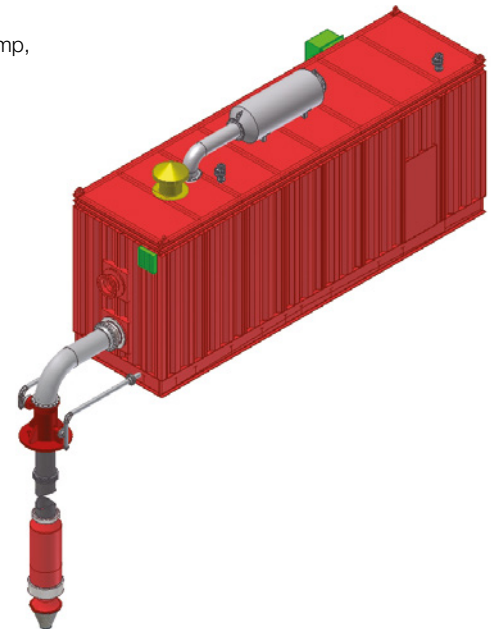

**The Sulzer Flow division keeps your processes flowing. Wherever fluids are treated, pumped, or mixed, we deliver highly innovative and reliable solutions for the most demanding applications.**

---

The Flow division specializes in pumping solutions specifically engineered for the processes of our customers. We provide pumps, agitators, compressors, grinders, screens and filters developed through intensive research and development in fluid dynamics and advanced materials. We are a market leader in pumping solutions for water, oil and gas, power, chemicals and most industrial segments.

---

E10022 en 10.2024, Copyright © Sulzer Ltd 2024

This brochure is a general presentation. It does not provide any warranty or guarantee of any kind. Please, contact us for a description of the warranties and guarantees offered with our products. Directions for use and safety will be given separately. All information herein is subject to change without notice.

