

**SULZER**

Original instructions

**Installation, operation and maintenance instructions  
Submersible Grinder Pump Type ABS Piranha S10 -  
PE125**





## Table of contents

<b>1. Important notice</b> .....	<b>4</b>
<b>2. Symbols and notices</b> .....	<b>4</b>
<b>3. General</b> .....	<b>5</b>
3.1. Hydraulics.....	5
3.2. Intended use and application.....	5
3.3. Identification code.....	6
<b>4. Performance range</b> .....	<b>6</b>
<b>5. Safety</b> .....	<b>6</b>
5.1. Personal protective equipment.....	7
<b>6. Use of motors in Ex zones</b> .....	<b>7</b>
6.1. Explosion-proof approvals.....	7
6.2. General information.....	7
6.3. Special conditions for safe use of S-type, explosion-proof motors.....	8
6.4. Operation of explosion-proof submersible pumps with VFD in hazardous areas (ATEX Zone 1 and 2).....	8
6.5. Operation of explosion-proof submersible pumps in wet well installation.....	8
<b>7. Technical data</b> .....	<b>8</b>
7.1. Nameplates.....	8
7.1.1. Nameplate drawings.....	9
<b>8. General design features</b> .....	<b>11</b>
8.1. Piranha-S.....	12
8.2. Piranha-S HH.....	13
8.3. Piranha-PE.....	14
<b>9. Weights</b> .....	<b>15</b>
9.1. Piranha - 50 Hz.....	15
9.2. Piranha - 60 Hz.....	16
9.3. Chain (EN 818)*.....	16
<b>10. Lifting, transport and storage</b> .....	<b>17</b>
10.1. Lifting.....	17
10.2. Transport.....	17
10.3. Storage.....	18
10.3.1. Moisture protection of motor connection cable.....	18
<b>11. Set-up and installation</b> .....	<b>18</b>
11.1. Equipotential bonding.....	19
11.1.1. Connection points.....	19
11.2. Discharge line.....	19
11.3. Installation types.....	20
11.3.1. Submerged in a concrete sump.....	20
11.3.2. Dry-installed.....	21
11.3.3. Transportable.....	22
11.3.4. Venting of the volute.....	22
<b>12. Electrical connection</b> .....	<b>23</b>
12.1. Capacitor ratings.....	24
12.2. Seal monitoring.....	24
12.3. Temperature monitoring.....	26
12.3.1. Temperature sensor bimetal.....	26













---

Table of contents	Page 3
12.4. Wiring diagrams.....	27
12.5. Operation with variable frequency drive (VFD) .....	28
<b>13. Commissioning.....</b>	<b>29</b>
13.1. Types of operation and frequency of starting.....	29
13.2. Direction of rotation.....	30
13.2.1. Checking direction of rotation.....	30
13.2.2. Changing direction of rotation.....	31
<b>14. Maintenance and service.....</b>	<b>31</b>
14.1. General maintenance instructions.....	32
14.1.1. Inspection intervals.....	32
14.2. Shredding system.....	32
14.3. Lubricant filling and changing.....	32
14.3.1. Drain and fill the seal chamber.....	33
14.4. Oil quantities (liters).....	33
14.5. Bottom plate adjustment.....	33
14.5.1. Re-setting the clearance gap following wear.....	33
14.6. Bearings and mechanical seals.....	35
14.7. Changing of the power cable.....	35
14.8. Clearing pump blockage.....	35
14.8.1. Instructions for operator.....	35
14.8.2. Instructions for service personnel.....	36
<b>15. Cleaning.....</b>	<b>37</b>
<b>16. Troubleshooting guide.....</b>	<b>37</b>
<b>17. Company details.....</b>	<b>38</b>

# 1. Important notice

	<b>NOTE</b>
	The original version of this document is in English. All other languages are a translation of the original. In case of a discrepancy, the English version will prevail.
	<b>NOTE</b>
	The layout and wording of the online version of this manual may vary from the printed version. The same information is provided in both.

# 2. Symbols and notices

	 <b>DANGER</b>
	Presence of dangerous voltage
	 <b>DANGER</b>
	Danger of an explosion occurring.
	 <b>WARNING</b>
	Hot surface - danger of burn or injury.
	 <b>WARNING</b>
	Hot liquid - danger of burn or injury.
	 <b>CAUTION</b>
	Non-compliance may result in personal injury.
	<b>ATTENTION</b>
	Non-observance may result in damage to the unit or negatively affect its performance.
	<b>NOTE</b>
	Important information for particular attention.

### 3. General

	<b>NOTE</b>
	Sulzer reserves the right to alter specifications due to technical developments.

### 3.1. Hydraulics

Table 1.

Submersible Grinder Pump Type ABS Piranha:						
50 Hz			60 Hz			
Ex <sup>(1)</sup> & Non-Ex	Ex <sup>(1)</sup>	Non-Ex	Ex <sup>(2)</sup> & Non-Ex <sup>(3)</sup>	Ex <sup>(2)</sup> & Non-Ex <sup>(3)</sup>	Ex <sup>(2)</sup> & Non-Ex <sup>(3)</sup>	Non-Ex <sup>(3)</sup>
S10/4W-50	PE30/2C-50	S21/2 HH-50	S10/4-60	PE25/2W-C-60	PE80/2-E-60	S26/2W HH-60
S12/2-50	PE 55/2E-50		S10/4W-60	PE28/2-C-60	PE100/2-E-60	
S12/2W-50	PE70/2E-50		S20/2-60	PE35/2-C-60	PE110/2-E-60	
S13/4-50	PE90/2E-50		S20/2W-60	PE35/2W-C-60	PE125/2-E-60	
S17/2-50	PE110/2E-50		S26/2W-60	PE45/2-C-60		
S17/2W-50			S30/2-60	PE45/2W-C-60		
S21/2-50						
S26/2-50						

**Approvals:** <sup>(1)</sup> ATEX. <sup>(2)</sup> FM. <sup>(3)</sup> CSA

### 3.2. Intended use and application

Piranha pumps have been designed for the pumping of sewage containing faecal matter from buildings and sites where the location is below the sewer level. In addition, Piranha pumps are ideal for effective and economical pressurized dewatering using pipes of small cross-sectional area, in private, municipal, and industrial applications.

These units must not be used in certain applications e.g. operating within flammable, combustible, chemical, corrosive, or explosive liquids.

	<b>ATTENTION</b>
	The maximum allowable temperature of the medium is 40 °C / 104 °F.

	<b>ATTENTION</b>
	Leakage of lubricants could result in pollution of the medium being pumped.

	<b>ATTENTION</b>
	Always consult with your local Sulzer representative for advice on approved use and application before installing the pump.

### 3.3. Identification code

Table 2.

<b>e.g. Piranha PE 30/2D-E Ex</b>	
<b>PE</b> = Modular motor version	<b>D</b> = Number of phases (D = 3~, W = 1~)
<b>30</b> = Motor power P2 kW x 10	<b>E</b> = Volute opening: C = 222 / 9; E = 265 / 10 (dia. mm / ins)
<b>2</b> = Number of poles	<b>Ex</b> = Explosion proof

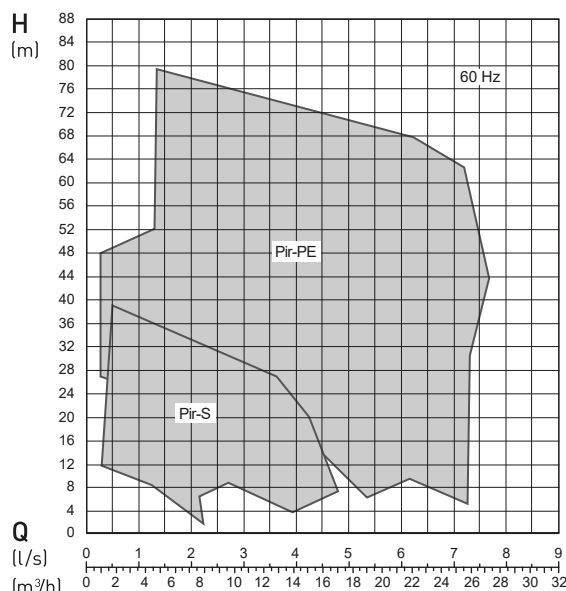
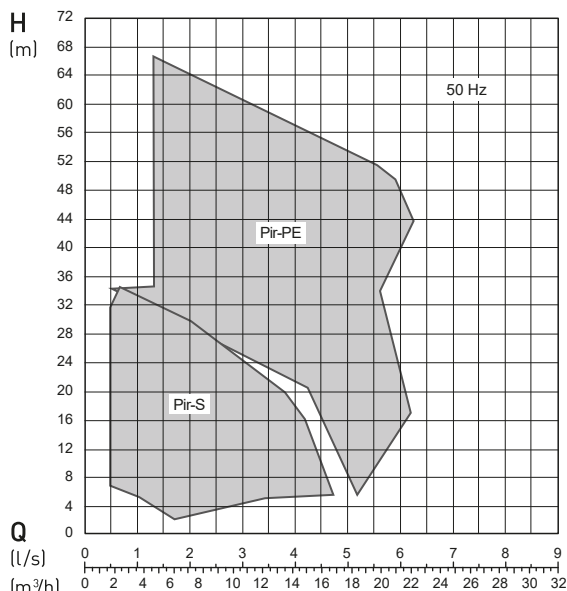

## 4. Performance range



## 5. Safety

The general and specific health and safety guidelines are described in detail in the “Safety Instructions for Sulzer Products Type ABS” booklet. If anything is unclear, or you have any questions regarding safety make certain to contact the manufacturer Sulzer.

**This unit can be used by children aged 8 years and above, and persons with reduced physical, sensory, or mental capabilities, or lack of experience and knowledge, when they have been given supervision or instruction concerning the safe use of the device and understand the hazards involved. Children must not play with the appliance. Cleaning and user maintenance should not be performed by children without supervision.**

	 <b>CAUTION</b>
	<p><b>Under no circumstances place a hand inside the suction or discharge openings unless the pump is completely isolated from the power supply.</b></p>

## 5.1. Personal protective equipment

Submersible electrical units can present mechanical, electrical, and biological hazards to personnel during installation, operation, and service. It is obligatory that appropriate personal protective equipment (PPE) is used. The minimum requirement is the wearing of safety glasses, footwear, and gloves. However, an on-site risk assessment should always be carried out to determine if additional equipment is required e.g. safety harness, breathing equipment etc.



## 6. Use of motors in Ex zones

### 6.1. Explosion-proof approvals

Explosion-proof motors of this series have certification in accordance with Factory Mutual (FM) Class 1Div. 1 Groups C and D (60 Hz, US), and ATEX 2014/34/EU [II 2G Ex db h IIB T4 Gb] (50 Hz).

	<b>NOTE</b>
	Ex protection method type c “Constructional Safety” and k “Liquid immersion” in accordance with EN ISO 80079-36, EN ISO 80079-37 are used.

### 6.2. General information

	 <b>DANGER</b>
	<p><b>Danger of explosion</b></p> <p>In hazardous areas care must be taken that during switching on and operation of the unit, the hydraulic section is filled with water (dry installation) or alternatively is submerged (wet well installation).</p>

1. The equipment must never run dry during operation. The volute must be filled with liquid during operation. Dry running during service and inspection is only permitted outside the classified area.
2. Explosion-proof submersible units may only be operated with the thermal sensing system connected.
3. Temperature monitoring of explosion-proof submersible units must be carried out by bi-metallic temperature limiters or thermistors according to DIN 44 082 connected to a suitable release device which is certified in accordance with EC directive 2014/34/EU and FM 3610.
4. Float switches, and any external seal monitoring (leakage sensor (DI), must be connected via an intrinsically safe electrical circuit, Protection Type EX (i), in accordance with IEC 60079-11 and FM 3610.
5. In the event that the unit is to be operated in explosive atmospheres using a variable speed drive (VFD), please contact your local Sulzer representative for technical advice regarding the various approvals and standards concerning thermal overload protection.

	<b>ATTENTION</b>
	Some units are approved for use in hazardous locations, and are fitted with a nameplate containing technical data and Ex certification. Repair work on Ex rated units must be carried out in Ex approved workshops by qualified personnel, using original parts supplied by the manufacturer. Otherwise it must no longer be used in hazardous locations, and where fitted, the Ex nameplate must be removed and replaced by a standard version.

	<b>NOTE</b>
	All local regulations and guidelines must be followed without exception.

### 6.3. Special conditions for safe use of S-type, explosion-proof motors

1. The integral supply cable shall be suitably protected from mechanical damage and terminated within an appropriate termination facility.
2. Pump motors rated for use with 50 Hz / 60 Hz sinusoidal supplies shall have the thermal protection devices connected in such a way that the machine is isolated from the supply in the event of the stator reaching 130 °C / 266 °F.
3. These motor units are not intended for user service or repair, any operation that may affect the explosion protection characteristics should be referred to the manufacturer. Repairs on flameproof joints may only be performed in accordance with the manufacturer's design specifications. Repair on the basis of the values in tables 2 and 3 of EN 60079-1 or annex B and D of FM 3615 is not permitted.

### 6.4. Operation of explosion-proof submersible pumps with VFD in hazardous areas (ATEX Zone 1 and 2)

Machines designated as Ex machines may never, without exception, be operated using a mains frequency that is greater than the maximum of 50 Hz or 60 Hz as indicated on the nameplate.

### 6.5. Operation of explosion-proof submersible pumps in wet well installation

It must be ensured that the hydraulic of the Ex submersible pump is always fully submerged during start-up and operation!

## 7. Technical data

Maximum noise level  $\leq 70$  dB. In some types of installations it is possible that during operation the noise level of 70 dB(A) or the measured noise level may be exceeded.

Detailed technical information is available in the technical data sheet which can be downloaded from <https://www.sulzer.com>

### 7.1. Nameplates

Some units are approved for use in hazardous locations, and are fitted with a nameplate containing technical data and Ex certification. Repair work on Ex rated units must be carried out in Ex approved workshops by qualified personnel, using original parts supplied by the manufacturer. Otherwise it must no longer be used in hazardous locations, and where fitted, the Ex nameplate must be removed and replaced by a standard version.

We recommend that you record the data from the standard nameplate on the unit in the legend below, and maintain it as a source of reference for the ordering of spare parts, repeat orders and general queries.

Always state the type, item number and serial number in all communications.



### 7.1.1. Nameplate drawings

Figure 1. Standard nameplates

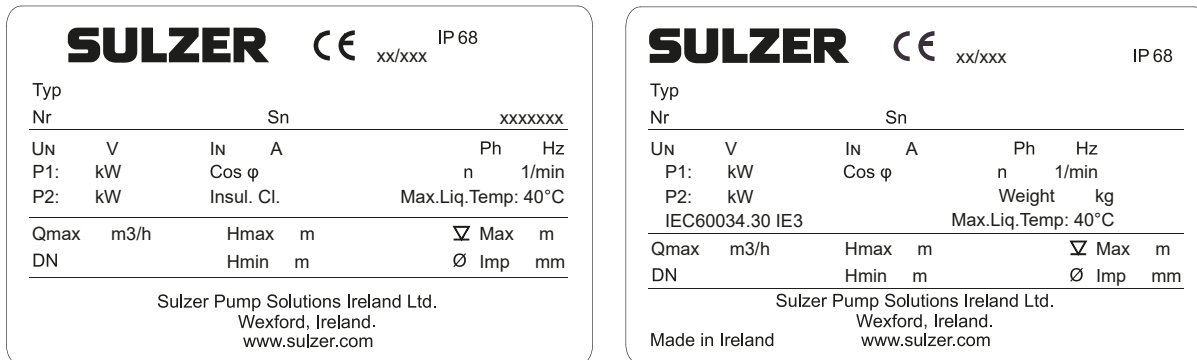

Piranha-S

Piranha-PE

Figure 2. ATEX nameplates

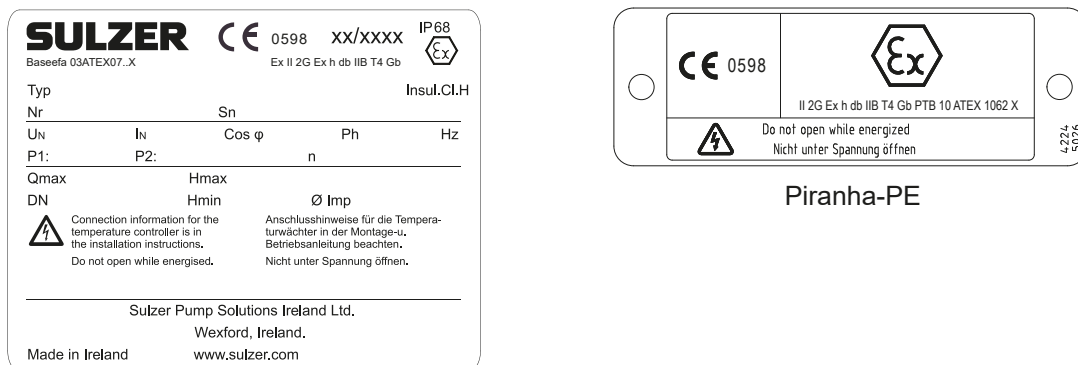

Piranha-S

Piranha-PE

Table 3. Legend

Legend	Description	Data
Typ	Pump type	
Nr	Item No.	
Sn	Serial No.	
xx/xxxx	Production date (Week/Year)	
UN	Rated voltage	V
IN	Rated current	A
Ph	Number of phases	
Hz	Frequency	Hz
P1	Rated input power	kW / hp
P2	Rated output power	kW / hp

table continued

Legend	Description	Data
xxxxxxx	Order number	
Cos φ	Power factor	pf
n	Speed	r/min
Weight		kg / lbs
Max.Liq.Temp.	Maximum liquid temperature	40 °C / 103 °F
Qmax	Maximum flow	m3 / h
DN	Discharge diameter	mm / ins
Hmax	Maximum head	m / ft
Hmin	Minimum head	m / ft
∇ Max	Maximum submergence depth	m / ft
Ø Imp	Impeller diameter	mm / ins
Insul. Cl.	Insulation Class	

Figure 3. FM and CSA nameplates

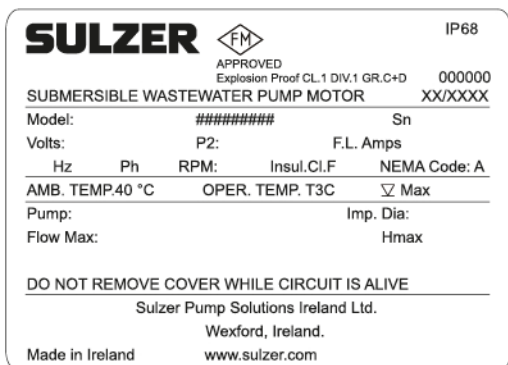

Piranha-S / Piranha-PE (FM)

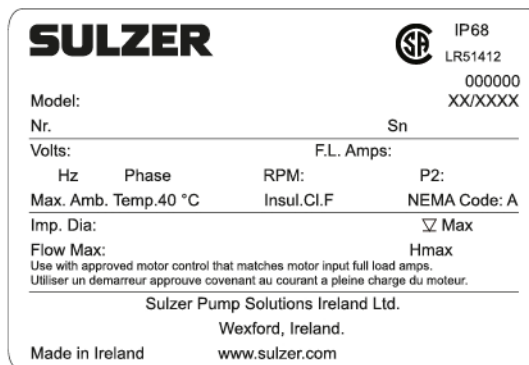

Piranha-S / Piranha-PE (CSA)

Table 4. Legend

Legend	Description	Data
Model	Pump type / item number	
Sn	Serial No.	
Volts	Rated voltage	V
P2	Rated output power	HP
F.L.Amps	Full load amps	A
Hz	Frequency	Hz
Ph	Number of phases	

table continued

Legend	Description	Data
RPM	Speed	rpm
Imp. dia.	Impeller diameter	mm / ins
∇ Max	Maximum submergence depth	m / ft
Insul. Cl.	Insulation class	
<b>NEMA Code</b>		
Flow Max	Maximum flow	gpm
Hmax	Maximum head	m / ft

## 8. General design features

Submersible grinder pump fitted with a shredding system hydraulic. The shredding system is located before the impeller and consists of a shredding rotor (A) in combination with a stationary cutting ring (B) fixed to a spiral bottom plate.

**Figure 4. Shredding system**

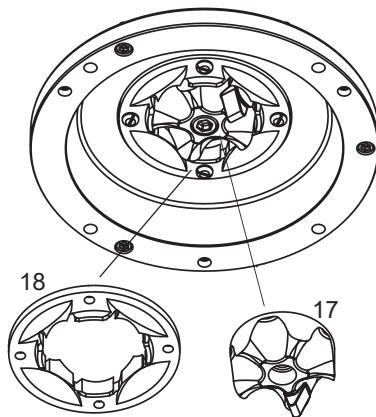

## 8.1. Piranha-S

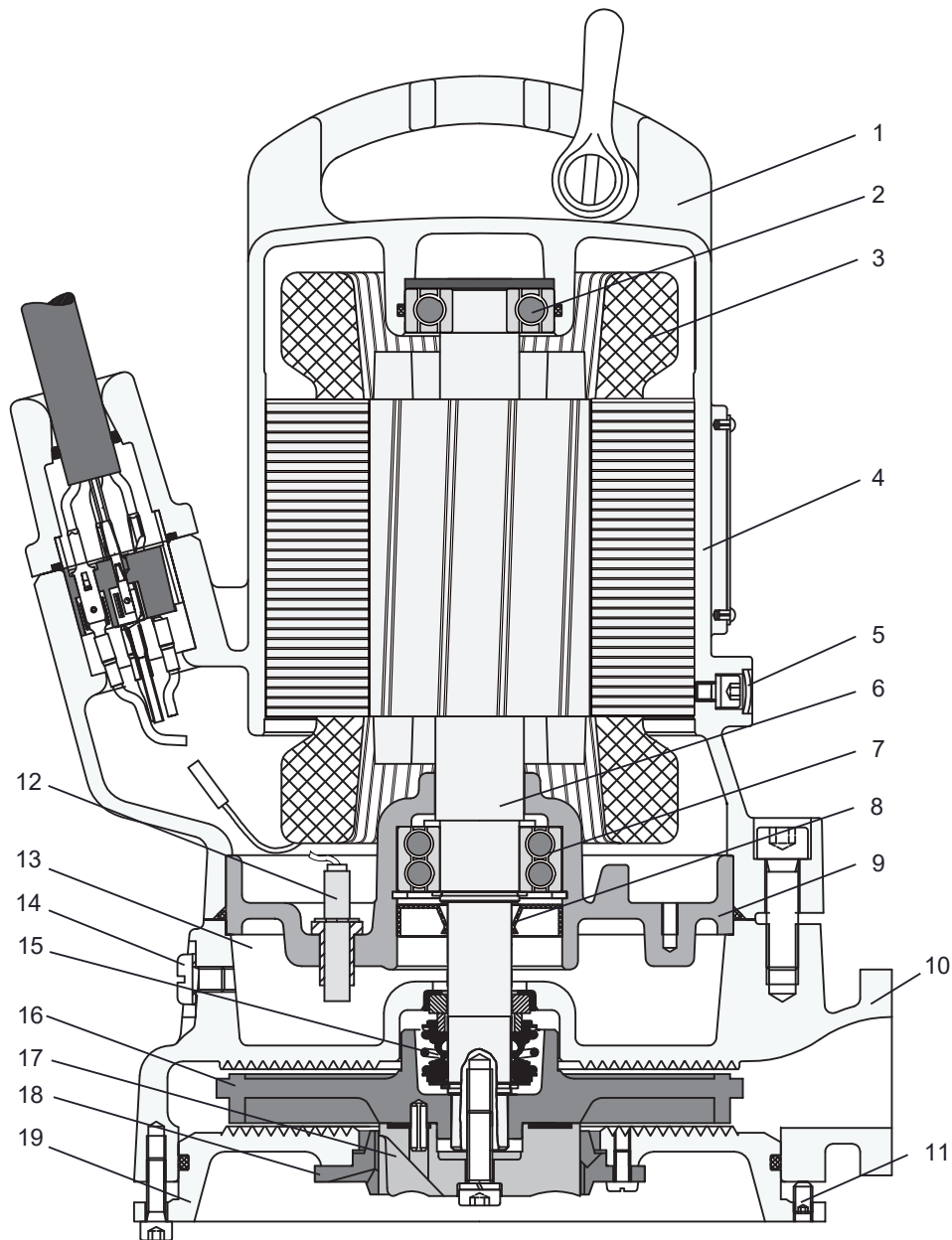

1. Cast iron lifting hoop and steel shackle
2. Upper bearing - single row
3. Motor with thermal sensors
4. Motor housing
5. Motor chamber pressure test point
6. Stainless steel shaft
7. Lower bearing - double row Oil-lubricated lip seal
8. Bearing housing
9. Volute
10. Bottom plate adjustment screw

8. General design features

- 11. Leakage sensor (DI)
- 12. Seal chamber
- 13. Seal chamber drain plug/pressure test point
- 14. Mechanical seal
- 15. Impeller
- 16. Shredding rotor
- 17. Cutting ring (fixed to bottom plate)
- 18. Bottom plate

## 8.2. Piranha-S HH

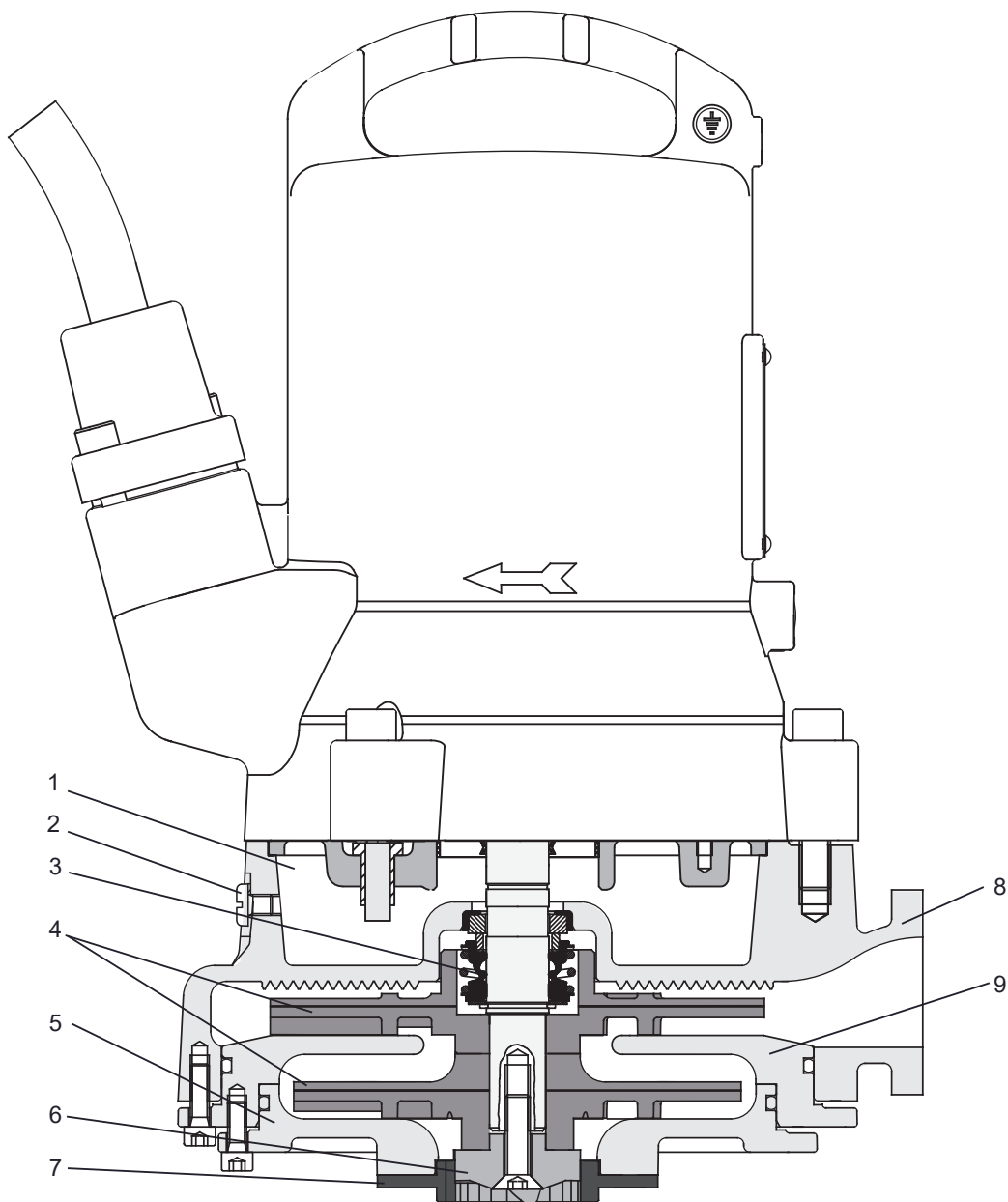

- 1. Seal chamber
- 2. Seal chamber drain plug / pressure test point

8. General design features

- 3. Mechanical seal
- 4. Impellers
- 5. Bottom plate
- 6. Shredding rotor
- 7. Cutting ring
- 8. Volute
- 9. Diffuser

### 8.3. Piranha-PE

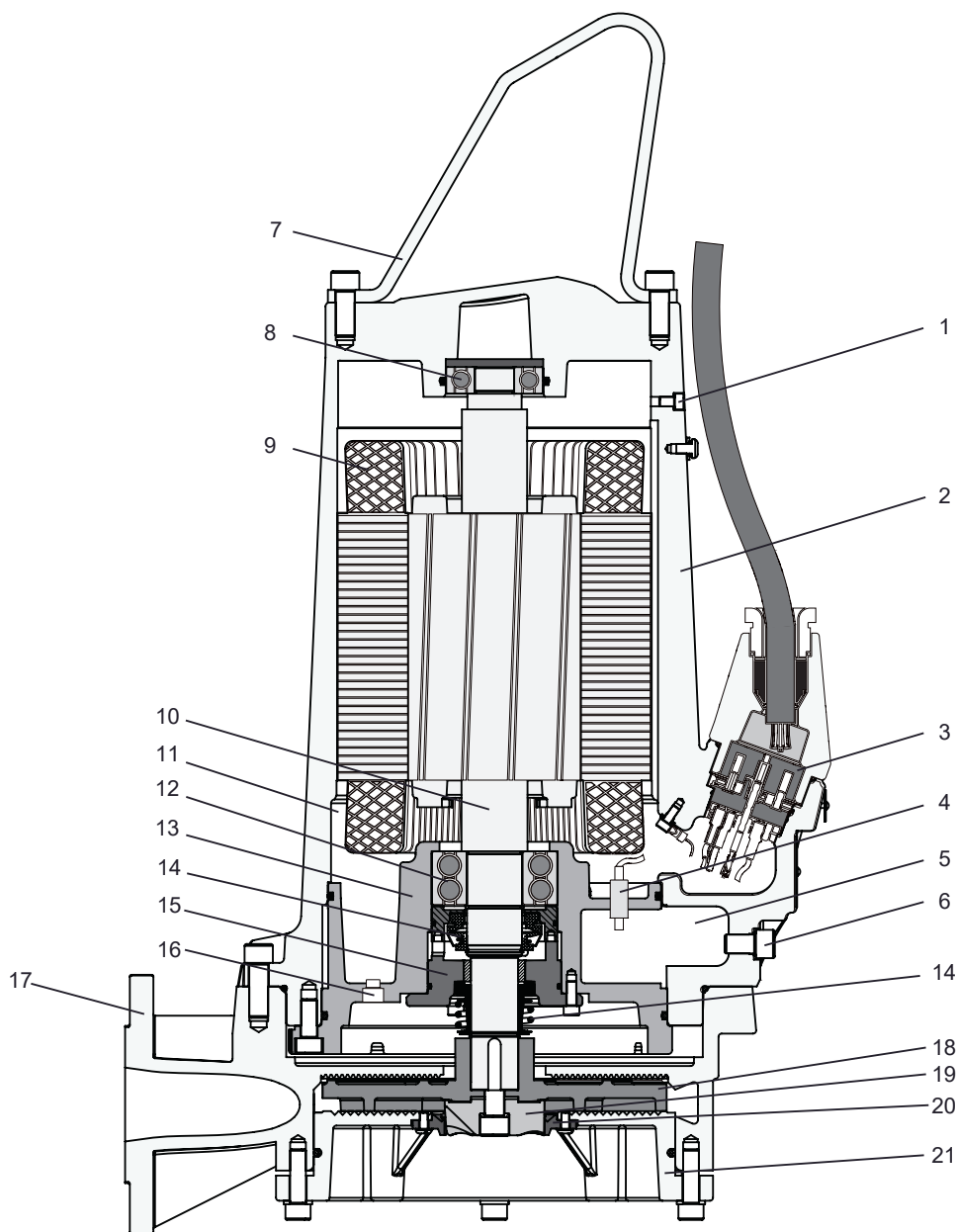

- 1. Pressure release screw
- 2. Motor housing
- 3. 10-pole terminal block

9. Weights

4. Leakage sensor (DI)
5. Seal chamber
6. Seal chamber drain plug / pressure test point
7. Stainless steel lifting hoop
8. Upper bearing - single row
9. Motor with thermal sensors
10. Stainless steel shaft
11. Motor chamber
12. Lower bearing - double row
13. Bearing housing
14. Mechanical seals
15. Seal holding plate
16. Motor chamber drain plug /pressure test point
17. Volute
18. Impeller
19. Shredding rotor
20. Cutting ring (fixed to bottom plate)
21. Bottom plate

## 9. Weights

	<b>NOTE</b>
	Weight on nameplate is for pump and cable only.

### 9.1. Piranha - 50 Hz

Table 5.

Piranha	Pedestal bracket and fasteners (kg / lbs)	Transportable pump stand (kg / lbs)	Cable (kg / lbs)		Pump without cable (kg / lbs)
			400 V <sup>1)</sup>	230 V <sup>2)</sup>	
S10 - S17	4 / 9	4 / 9	0.2 / 0.4	-	30 / 66
S21	4 / 9	4 / 9	0.2 / 0.4	-	32 / 71
S21HH	4 / 9	4 / 9	0.2 / 0.4	0.2 / 0.4	37 / 82
S26	4 / 9	4 / 9	0.2 / 0.4	-	35 / 77
PE 30/2D	4 / 9	4 / 9	0.3 / 0.7	-	82 / 181
PE 55/2D	7 / 15	4 / 9	0.4 / 0.9	-	122 / 269
PE 70/2D	7 / 15	4 / 9	0.4 / 0.9	-	126 / 278
PE 90/2D, PE 110/2D	7 / 15	4 / 9	0.4 / 0.9	-	148 / 326

<sup>1)</sup> Weight per meter. <sup>2)</sup> Weight per foot.

## 9.2. Piranha - 60 Hz

Table 6.

Piranha	Pedestal bracket and fasteners (kg / lbs)	Transportable pump stand (kg / lbs)	Cable (kg / lbs)				Pump without cable (kg / lbs)
			208 V <sup>2)</sup>	230 V <sup>2)</sup>	460 V <sup>2)</sup>	600 V <sup>2)</sup>	
S10 & S20	4 / 9	4 / 9	0.13 / 0.29	0.13 / 0.29	0.13 / 0.29	-	30 / 66
S26	4 / 9	4 / 9	0.13 / 0.29	0.13 / 0.29	-	-	35 / 77
S26HH	4 / 9	4 / 9	-	0.13 / 0.29	-	-	37 / 82
S30	4 / 9	4 / 9	0.13 / 0.29	0.13 / 0.29	0.13 / 0.29	-	51 / 112
PE 25/2W	4 / 9	4 / 9	0.18 / 0.4	0.18 / 0.4	-	-	77 / 170
PE 28/2D	4 / 9	4 / 9	0.14 / 0.3	0.14 / 0.3	0.14 / 0.3	0.14 / 0.3	77 / 170
PE 35/2W	4 / 9	4 / 9	0.23 / 0.5	0.23 / 0.5	-	-	77 / 170
PE 35/2D	4 / 9	4 / 9	0.18 / 0.4	0.14 / 0.3	0.14 / 0.3	0.14 / 0.3	77 / 170
PE 45/2W	4 / 9	4 / 9	0.23 / 0.5	0.23 / 0.5	-	-	80 / 176
PE 45/2D	4 / 9	4 / 9	0.23 / 0.5	0.18 / 0.4	0.18 / 0.4	0.14 / 0.3	80 / 176
PE 80/2D	7 / 15	4 / 9	0.23 / 0.5	0.23 / 0.5	0.18 / 0.4	0.14 / 0.3	124 / 273
PE 100/2D	7 / 15	4 / 9	0.23 / 0.5	0.23 / 0.5	0.23 / 0.5	0.18 / 0.4	153 / 337
PE 110/2D	7 / 15	4 / 9	0.23 / 0.5	0.23 / 0.5	0.23 / 0.5	0.23 / 0.5	153 / 337
PE 125/2D	7 / 15	4 / 9	0.23 / 0.5	0.23 / 0.5	0.23 / 0.5	0.23 / 0.5	153 / 337



<sup>1)</sup> Weight per meter. <sup>2)</sup> Weight per foot.

## 9.3. Chain (EN 818)\*

Length (m / ft)	Weight (kg / lbs)		
	WLL 320	WLL 400	WLL 630
1.6 / 5.24	0.74 / 1.63	-	-
3.0 / 9.84	1.28 / 2.82	1.62 / 3.57	2.72 / 5.99
4.0 / 13.12	1.67 / 3.68	2.06 / 4.54	3.40 / 7.49
6.0 / 19.68	2.45 / 5.40	2.94 / 6.48	4.76 / 10.49
7.0 / 22.96	2.84 / 6.26	3.38 / 7.45	4.92 / 10.84

\* For chain supplied by Sulzer only.



	 <b>CAUTION</b>
	<b>Weights of accessories, other than or in addition to those listed, must also be included when specifying the working load of any lifting equipment. Please consult with your local Sulzer representative prior to installation.</b>

## 10. Lifting, transport and storage

### 10.1. Lifting

	<b>ATTENTION</b>
	<b>Observe the total weight of the Sulzer units and their attached components! (see nameplate for weight of base unit).</b>

The duplicate nameplate provided must always be located and visible close to where the unit is installed (e.g. at the terminal boxes / control panel where the cables are connected).

	<b>NOTE</b>
	<b>Lifting equipment must be used if the total unit weight and attached accessories exceeds local manual lifting safety regulations.</b>

The total weight of the unit and accessories must be observed when specifying the safe working load of any lifting equipment! The lifting equipment, e.g. crane and chains, must have adequate lifting capacity. The hoist must be adequately dimensioned for the total weight of the Sulzer units (including lifting chains or steel ropes, and all accessories which may be attached). The end user assumes sole responsibility that lifting equipment is certified, in good condition, and inspected regularly by a competent person at intervals in accordance with local regulations. Worn or damaged lifting equipment must not be used and must be properly disposed of. Lifting equipment must also comply with the local safety rules and regulations

	<b>NOTE</b>
	<b>The guidelines for the safe use of chains, ropes and shackles supplied by Sulzer are outlined in the Lifting Equipment manual provided with the items and must be fully adhered to.</b>

### 10.2. Transport

During transport, care should be taken that the pump cannot fall over or roll and cause damage to the pump or injury to the person. The pumps have a lifting hoop for lifting or suspension of the pump.

	 <b>CAUTION</b>
	After removal from its original packaging we recommend that during future transportation of the pump it is laid on its side and securely strapped to a pallet.

	 <b>DANGER</b>
	<b>Dangerous voltage</b> The pump must be raised only by the lifting hoop and never by the power cable.

## 10.3. Storage

1. During long periods of storage the pump should be protected from moisture and extremes of cold or heat.
2. To prevent the mechanical seals from sticking it is recommended that occasionally the impeller is rotated by hand.
3. If the pump is being taken out of service the oil should be changed before storage.
4. After storage the pump should be inspected for damage, the oil level should be checked, and the impeller checked to ensure it rotates freely.

### 10.3.1. Moisture protection of motor connection cable

The motor connection cables are protected against the ingress of moisture along the cable by having the ends sealed at the factory with protective covers (only Piranha-PE).

	<b>NOTE</b>
	The ends of the cables should never be immersed in water as the protective covers only provide protection against water spray or similar (IP44) and are not a water tight seal. The covers should only be removed immediately prior to connecting the units electrically.

During storage or installation, prior to the laying and connection of the power cable, particular attention should be given to the prevention of water damage in locations which could flood.



	<b>NOTE</b>
	If there is a possibility of water ingress then the cable should be secured so that the end is above the maximum possible flood level. Take care not to damage the cable or its insulation when doing this.

## 11. Set-up and installation



These units are designed for wet well vertical installation on a fixed pedestal or as transportable on a movable pump stand. The pumps are also suitable for horizontal dry installation. The regulations of DIN EN 12056-4 as well as other local codes should be observed.

The following guidelines must be observed when setting the lowest switch off point for Piranha pumps:

- Care must be taken during switching on and operation that the hydraulic section is filled with water (dry installation) or alternatively is submerged or under water (wet installation). Other types of operation e.g. snore operation or dry running are not allowed!
- The minimum submergence allowed for specific pumps can be found on the dimension installation sheets available by download from <https://www.sulzer.com>

	 <b>DANGER</b>
	The regulations covering the use of pumps in sewage applications, together with all regulations involving the use of explosion-proof motors, should be observed. The cable ducting to the control panel should be sealed off in a gas-tight manner by the use of a foaming material after the cable and control circuits have been pulled through. In particular the safety regulations covering work in enclosed areas in sewage plants should be observed together with general good technical practice.

## 11.1. Equipotential bonding

	 <b>DANGER</b>
	<p><b>Dangerous voltage</b></p> <p>In pump stations/tanks, equipotential bonding must be carried out according to EN60079-14:2014 [Ex] or IEC 60364-5-54 [non-Ex] (Regulations for the installation of pipelines, protective measures in high voltage systems).</p>

### 11.1.1. Connection points

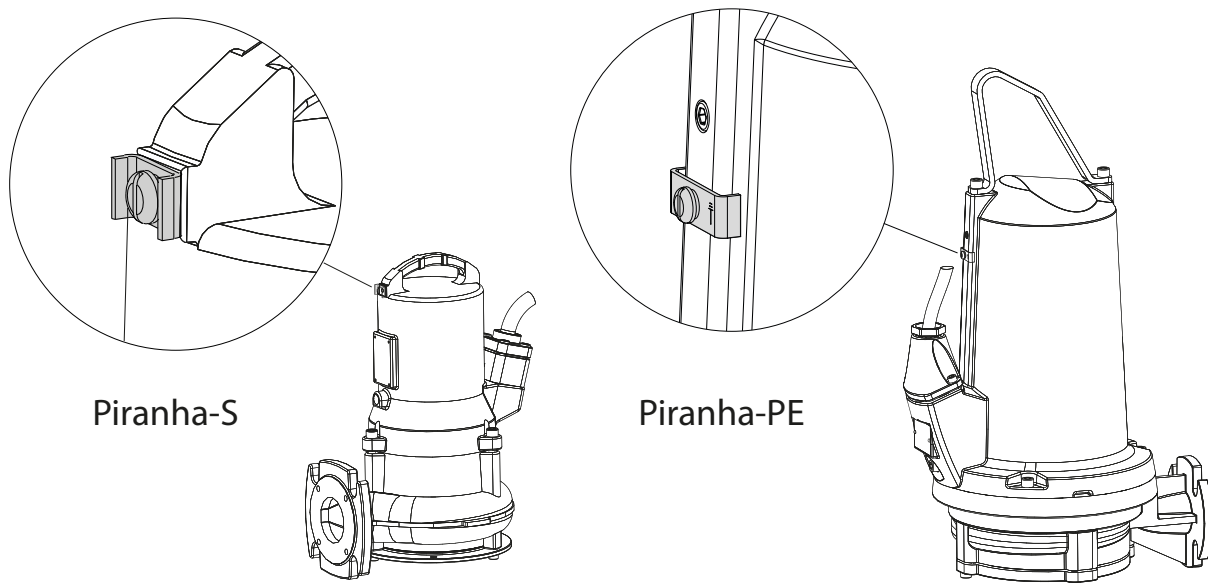

## 11.2. Discharge line

The discharge line must be installed in compliance with the relevant regulations. DIN 1986/100 and EN 12056 applies in particular to the following:

- The discharge line should be fitted with a backwash loop (180° bend) located above the backwash level and should then flow by gravity into the collection line or sewer.
- The discharge line should not be connected to a down pipe.
- No other inflows or discharge lines should be connected to this discharge line.

	<b>ATTENTION</b>
	<p>The discharge line should be installed so that it is not affected by frost.</p>

## 11.3. Installation types

### 11.3.1. Submerged in a concrete sump

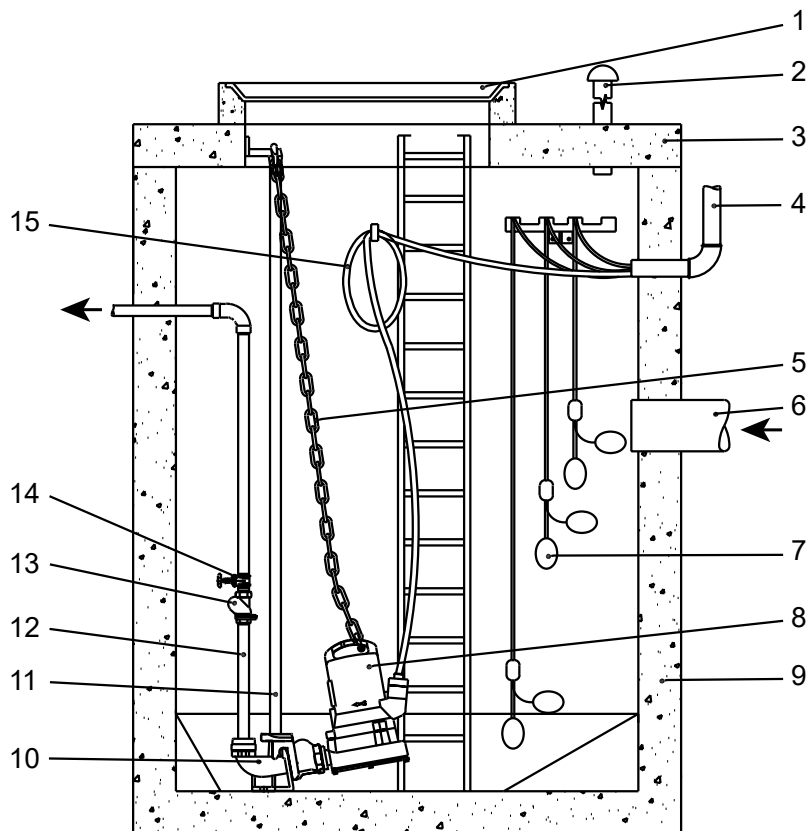

- 1 Sump cover
- 2 Venting line
- 3 Sump cover
- 4 Protective duct to the control panel for cable
- 5 Chain
- 6 Inflow line
- 7 Ball type float switch
- 8 Submersible pump
- 9 Concrete sump
- 10 Pedestal
- 11 Guide rail
- 12 Discharge line
- 13 Non-return valve
- 14 Gate valve
- 15 Power cable to motor

The pump is installed using the Sulzer pedestal kit as specified below for the particular model (assembly leaflet is supplied with the kit).

**Note:** The fitting of a guide rail is compulsory when the pump is installed on a pedestal.

Table 7.

Piranha	Size	Part number
S10/4 - S30/2	G 1¼": 90° cast bend	62320674
	G 1¼": 90° cast bend with built-in non-return valve	62320536
PE30/2C	G 1¼": 90° cast bend	62320676
	G 1¼": 90° cast bend with built-in non-return valve	62320538
PE55/2E - 125/2E	DN 50 / G2" without bend (DIN)	62320660
	DN 50 / G2" without bend (ASA)	62320661

**Particular attention should be paid to:**

- the provision of venting to the sump.
- installation of isolating valves on the discharge line.
- removal of any slack from the power cable by coiling and securing it to the sump wall so that it cannot be damaged during operation of the pump.

	<b>NOTE</b>
	The power cable should be handled carefully during installation and removal of the pump in order to avoid damage to the insulation. When raising the pump out of the concrete sump with the hoist ensure that the connection cables are lifted out simultaneously as the pump itself is being raised.

## 11.3.1.1. Lowering of the pump on the guide rail

**Procedure**

1. Fit the pedestal coupling bracket and seal to the discharge flange of the pump.
2. Fit a chain to the lifting hoop and using a hoist lift the pump into position where the pedestal bracket can slide into place on the guide rail.

**Note: Piranha S10/4 - S30/2:** To allow the pump to be lowered at the correct angle and fixed correctly to the pedestal, the shackle must be fixed to the lifting hoop at the point furthest from the guide rail.

**Note: Piranha PE30/2C - 125/2E:** Due to the design of the lifting hoop the pump will automatically lower at the necessary angle.

3. Lower the pump slowly down along the guide rail.
4. The pump couples automatically on the pedestal, and seals to a leak-tight connection by the compression from the combination of its own weight and the fitted seal.

## 11.3.2. Dry-installed

The pump is installed using the Sulzer horizontal support kit as specified for the particular model.



Table 8.

Piranha	Part number
S10/4 - S30/2	62665103
PE30/2C	62665399
PE55/2E - PE125/2E	62665400

**Particular attention should be paid to:**

- The provision of venting to the sump.
- Installation of isolating valves on the inlet and discharge lines.
- Removal of any slack from the power cable by coiling and securing it so that it cannot be damaged during operation of the pump.

	<b>ATTENTION</b>
	The power cable should be handled carefully during installation and removal of the pump in order to avoid damage to the insulation.

	 <b>WARNING</b>
	<p><b>Hot Surface</b></p> <p>When dry-installed the pump motor housing may become hot. In such a case, to avoid burn injury, allow to cool down before handling.</p>



### 11.3.3. Transportable

**About this task**

For transportable installation the Piranha is fitted to a pump stand.

Hoses, pipes and valves must be sized to suit the pump performance.

	 <b>DANGER</b>
	<p><b>Dangerous voltage</b></p> <p>Arrange the cable run so that the cables will not be kinked or nipped.</p>

	 <b>DANGER</b>
	<p><b>Dangerous voltage</b></p> <p>Submersible pumps used outdoors must be fitted with a power cable of at least 10 meter length. Other regulations may apply in different countries.</p>



**Procedure**

1. Place the pump on a firm surface which will prevent it from overturning or burrowing down. The pump stand can also be bolted down to the floor surface, or the pump suspended slightly by the lifting hoop.
2. Connect the discharge pipe and cable

### 11.3.4. Venting of the volute

After lowering the pump into the sump medium, an air lock may occur in the volute causing pumping problems. To clear the air lock, you can shake the pump and/or raise and lower the pump in the medium, until the resulting air bubbles no longer appear at surface level. If necessary, repeat this venting procedure.



## 12. Electrical connection

	 <b>DANGER</b>
	<p><b>Dangerous voltage</b></p> <p>Before commissioning, an expert should check that one of the necessary electrical protective devices is available. Earthing, neutral, earth leakage circuit breakers, etc. must comply with the regulations of the local electricity supply authority and a qualified person should check that these are in perfect order.</p>

	<b>ATTENTION</b>
	<p>The power supply system on site must comply with local regulations with regard to cross-sectional area and maximum voltage drop. The voltage stated on the nameplate of the pump must correspond to that of the mains.</p>

Suitably rated means of disconnection shall be incorporated in the fixed wiring by the installer for all pumps in accordance with applicable local National codes.

The power supply cable must be protected by an adequately dimensioned slow-blow fuse corresponding to the rated power of the pump.



	 <b>DANGER</b>
	<p><b>Dangerous voltage</b></p> <p>The incoming power supply as well as the connection of the pump itself to the terminals on the control panel must comply with the circuit diagram of the control panel as well as the motor connection diagrams and must be carried out by a qualified person.</p>

All relevant safety regulations as well as general good technical practice must be complied with.

Submersible pumps used outdoors must be fitted with a power cable of at least 10 meter length. Other regulations may apply in different countries.

In all installations, the power supply to the pump must be via a residual current device (e.g. RCD, ELCB, RCBO etc.) with a rated residual operating current in accordance with local regulations. For installations not having a fixed residual current device the pump must be plugged into the power supply through a portable version of the device.

All three phase pumps must be installed with motor starting and overload protective devices in the fixed wiring by the installer. Such motor control and protective devices must comply with the requirements of IEC standard 60947-4-1. They must be rated for the motor that they control, and wired and set/adjusted according to the instructions provided by the manufacturer. In addition, the overload protective device that is responsive to the motor current shall be set / adjusted to 125% of the marked rated current.

	 <b>DANGER</b>
	<p><b>Dangerous voltage</b></p> <p>Risk of electrical shock. Do not remove cord and strain relief and do not connect conduit to pump.</p>

	<b>NOTE</b>
	<p>Please consult your electrician.</p>

The following components should be incorporated in the fixed wiring for all single phase pumps:

- Motor starting and/or running capacitor that complies with the requirements of IEC 60252-1 and rated as specified in the installation instruction. The capacitor shall be class S2 or S3.
- Motor contactor that complies with the requirements of IEC Standard 60947-4-1 and rated for the motor that it controls.

## 12.1. Capacitor ratings

**Table 9.**

<b>PE1 Capacitor Ratings</b>			
<b>Motor</b>	<b>Start (µF)</b>	<b>Run (µF)</b>	<b>Voltage (V)</b>
PE25/2W	180	70	450
PE35/2W	180	70	450
PE45/2W	180	70	450

	<b>NOTE</b>
	The supply cord must be replaced by the manufacturer, its service agent or a similar qualified person.

## 12.2. Seal monitoring

Piranha-PE pumps are supplied as standard with a leakage sensor (DI), to detect and alert to the ingress of water into the motor and seal chambers. Piranha-S pumps can be fitted with an optional leakage sensor (Ex version monitors the motor chamber only).

In order to integrate this seal monitoring function into the control panel of the pump it is necessary to fit a Sulzer DI module and connect this in accordance with the circuit diagram below.



**Figure 5. Sulzer leakage control type CA 461**

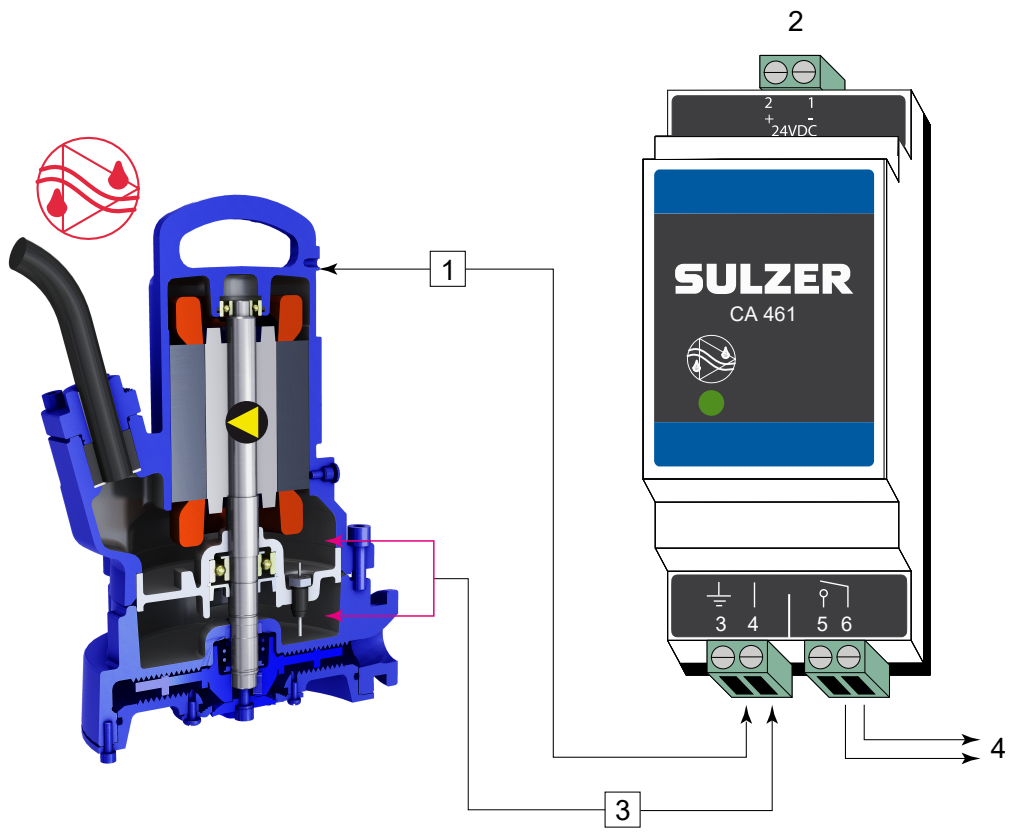

- 1 Connect terminal 3 to ground or housing of the pump.
- 2 Power supply
- 3 Leakage input
- 4 Output

**Electronic amplifier**

110 - 230 V AC 50/60 Hz (CSA) - Part No.: 16907010. 18 - 36 VDC, SELV - Part No.: 16907011

Multiple-input leakage control modules are also available. Please consult with your local Sulzer representative.

<b>!</b>	<b>ATTENTION</b>
	Maximum relay contact loading: 2 Ampere
<b>!</b>	<b>ATTENTION</b>
	It is very important to note that with the connection example above it is not possible to identify which sensor/alarm is being activated. As an alternative Sulzer highly recommends to use a separate CA 461 module for each sensor/input, to allow not only identification but also to prompt to the appropriate response to the alarm category/severity.
<b>!</b>	<b>ATTENTION</b>
	If the leakage sensor (DI) is activated the unit must be immediately taken out of service. Please contact your Sulzer service center.

<b>!</b>	<b>NOTE</b>
	Running the pump with the thermal and/or leakage sensors disconnected will invalidate related warranty claims.

### 12.3. Temperature monitoring

Thermal sensors in the stator windings protect the motor from overheating.

Piranha motors are fitted with bimetallic thermal sensors in the stator as standard in Piranha-PE and Piranha-S Ex, and as an option with Piranha-S (non-Ex).

#### 12.3.1. Temperature sensor bimetal

Figure 6. Curve showing operation principle of bimetallic temperature limiter

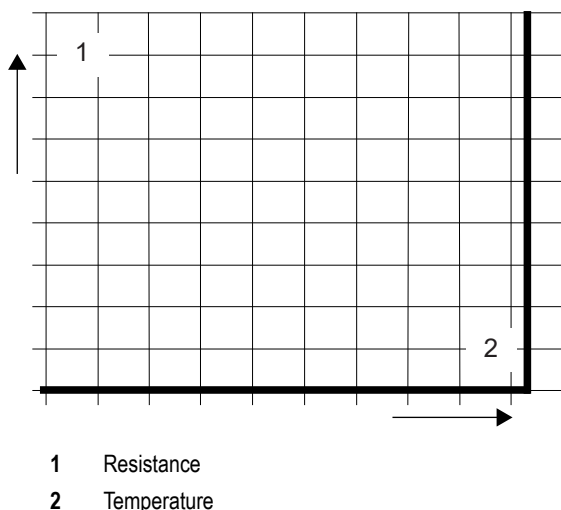

Table 10.

Application	Option
Function	Temperature switch using the bimetallic principle, which opens at a rated temperature
Switching	Taking care not to exceed the allowable switching current, these can be fitted directly into the control circuit

**Operating voltage AC...100 V to 500 V ~**

**Rated voltage AC...250 V**

**Rated current AC cos φ = 1,0...2.5 A**

**Rated current AC cos φ = 0,6...1.6 A**

**Max. switching current at I<sub>N</sub>...5.0 A**

<b>!</b>	<b>ATTENTION</b>
	The maximum switching ability of the thermal sensors is 5 A, the rated voltage 250 V.

## 12.4. Wiring diagrams

Figure 7. Single phase

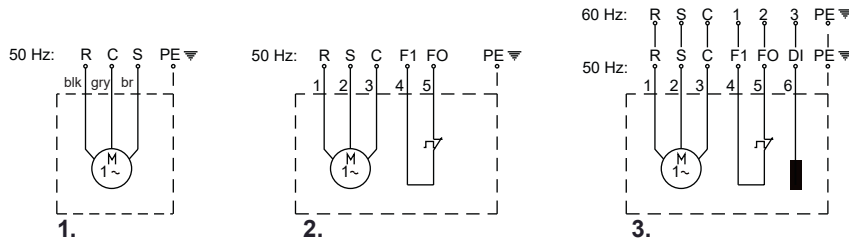

Figure 8. Three phase

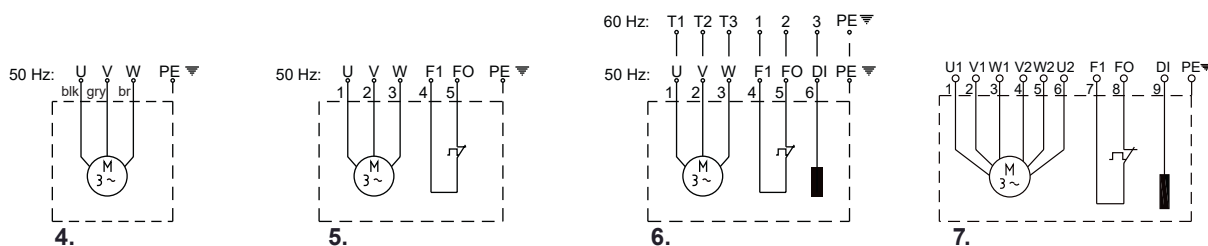



Table 11. Legend: Single phase / three phase wiring diagrams

R = Run	F1, F0 = Thermal sensor	blk = Black
S = Start	DI = Seal monitor	gry = Grey
C = Neutral (Common)	PE = Earth	br = Brown

**Table 12.**

Piranha	1	2	3	4	5	6	7
	Single phase			Three phase			
50 Hz	S10/4	S10/4-Ex	S10/4	S13/4	S13/4-Ex	S13/4	PE55/2E-Ex
	S12/2	S12/2-Ex	S10/4-Ex	S12/2	S12/2-Ex	S13/4-Ex	PE70/2E-Ex
	S17/2	S17/2-Ex	S12/2	S17/2	S17/2-Ex	S12/2	PE90/2E-Ex
			S12/2-Ex	S21/2	S21/2-Ex	S12/2-Ex	PE110/2E-Ex
			S17/2	S21/2HH	S26/2-Ex	S17/2	
			S17/2-Ex	S26/2		S17/2-Ex	
60 Hz	-	-	S10/4	-	-	S10/4	-
			S10/4-Ex			S10/4-Ex	
			S20/2			S20/2	
			S20/2-Ex			S20/2-Ex	
			S26/2			S30/2	
			S26/2-Ex			S30/2-Ex	
			S26/2-HH			PE28/2C-Ex	
			PE25/2C-Ex			PE35/2C-Ex	
			PE35/2C-Ex			PE45/2C-Ex	
			PE45/2C-Ex			PE80/2E-Ex	
						PE100/2E-Ex	
						PE110/2E-Ex	
						PE125/2E-EXx	
* 400/695V							

	<b>ATTENTION</b>
	It is important to use the correct capacitors with single phase pumps, use of incorrect capacitors will lead to motor burn-out.

## 12.5. Operation with variable frequency drive (VFD)

The stator design and the insulation grade of the motors from Sulzer means that they are suitable for usage with VFD, according to IEC 60034-25:2022 / NEMA 61800-2:2005. It is however essential that the following conditions are met

- The guidelines for EMC (electromagnetic compatibility) are complied with.
- Explosion-proof motors must be equipped with thermistors (PTC temperature sensors) if operated in hazardous areas (ATEX Zone 1 and 2).
- Machines designated as Ex machines may never, without exception, be operated using a mains frequency that is greater than the maximum of 50 Hz or 60 Hz as indicated on the nameplate. Make sure that the rated current specified on the nameplate is not exceeded after starting the motors. The maximum number of starts according to the motor data sheet may not be exceeded.
- Machines that are not designated as Ex machines may only be operated using the mains frequency indicated on the nameplate. Greater frequencies can be used but only after consulting with and receiving permission from the Sulzer manufacturing plant.
- For operation of Ex-motors on VFD's, special requirements in relation to the tripping times of the thermo control elements must be observed.
- The lowest frequency must be set so that the minimum fluid velocity of 1 m/s is present in the volute.
- The maximum frequency must be set so that the rated power of the motor is not exceeded.

VFD's must be equipped with adequate filters when used in the critical zone. The filter chosen must be suitable for the VFD with regard to its rated voltage, wave frequency, rated current, and maximum output frequency. Ensure that the voltage characteristics (voltage peaks, dU/dt and rise time of the voltage spikes) at the motor terminal board is in accordance to IEC 60034-25:2022 / NEMA 61800-2:2005. This can be achieved using various types of VFD filters, depending on the specified voltage and cable length. Please contact your supplier for detailed information and the correct configuration

## 13. Commissioning

	 <b>CAUTION</b>
	All safety hints in other sections must be observed!

Before commissioning, the pump should be checked and a functional test carried out. Particular attention should be paid to the following:

- Have the electrical connections been carried out in accordance with regulations?
- Have the thermal sensors been connected?
- Is the seal monitoring device correctly installed?
- Is the motor overload switch correctly set?
- Does the unit sit correctly on the pedestal?
- Is the direction of rotation correct - even if run via an emergency generator?
- Are the switching ON and switching OFF levels set correctly?
- Are the level control switches functioning correctly?
- Are the required gate valves (where fitted) open?
- Do the non-return valves (where fitted) function easily?
- Has the volute been vented?
- Have the power and control circuit cables been correctly fitted?
- Was the sump cleaned out?
- Have the inflow and outflows of the pump station been cleaned and checked?
- Have the hydraulics been vented in the case of dry installed units?

### 13.1. Types of operation and frequency of starting

Pumps of the Piranha-PE series have been designed for continuous operation S1 when either submerged or dry-installed.

Piranha-S has been designed for intermittent use only (S3, 25%) when dry-installed, and continuous use (S1) when submerged (minimum water level = 279 mm / 11 ins).

## 13.2. Direction of rotation

### 13.2.1. Checking direction of rotation

When three phase units are being commissioned for the first time, and also when used on a new site, the direction of rotation must be carefully checked by a qualified person.

	<b>CAUTION</b>
	<p><b>The direction of rotation should only be altered by a qualified person.</b></p> <p>When checking the direction of rotation, the pump should be secured in such a manner that no danger to personnel is caused by the rotating impeller or by the resulting air flow. Do not place your hand into the hydraulic system!</p>

	<b>CAUTION</b>
	<p>When checking the direction of rotation, or when starting the unit, pay attention to the <b>START REACTION</b>. This can be very powerful and cause the pump to jerk in the opposite direction to the direction of rotation.</p>

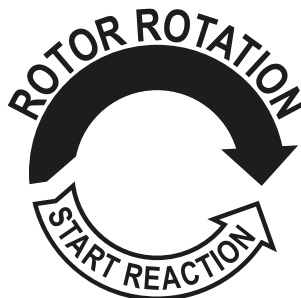



	<b>ATTENTION</b>
	<p>When viewed from above, the direction of rotation is correct if the impeller rotates in a clockwise manner.</p>

	<b>NOTE</b>
	<p>The start reaction is anti-clockwise.</p>







	<b>ATTENTION</b>
	<p>If a number of pumps are connected to a single control panel then each unit must be individually checked.</p>

	<b>ATTENTION</b>
	<p>The mains supply to the control panel should have a clockwise rotation. If the leads are connected in accordance with the circuit diagram and lead designations, the direction of rotation will be correct.</p>

### 13.2.2. Changing direction of rotation

	<b>CAUTION</b>
	<p><b>The direction of rotation should only be altered by a qualified person.</b></p> <p>If the direction of rotation is incorrect then this is altered by changing over two phases of the power supply cable in the control panel. The direction of rotation should then be rechecked.</p>
	<b>NOTE</b>
	<p>The direction of rotation measuring device monitors the direction of rotation of the mains supply or that of an emergency generator.</p>

## 14. Maintenance and service

	<b>DANGER</b>
	<p><b>Dangerous voltage</b></p> <p>Before commencing any maintenance work the unit should be completely disconnected from the mains by a qualified person and care should be taken that it cannot be inadvertently switched back on.</p>
	<b>CAUTION</b>
	<p>When carrying out any on-site service or maintenance work i.e. cleaning, venting, fluid inspection or changing, and adjustment of the bottom plate gap, the safety regulations covering work in enclosed areas of sewage installations as well as good general technical practices should be followed.</p>
	<b>CAUTION</b>
	<p>Repair work must only be carried out by qualified personnel approved by Sulzer.</p>
	<b>WARNING</b>
	<p><b>Hot surface</b></p> <p>Under continuous running conditions the pump motor housing can become very hot. To prevent burn injury allow to cool down before handling.</p>
	<b>WARNING</b>
	<p><b>Hot liquid</b></p> <p>Coolant temperature can reach up to 60 °C under normal operating conditions.</p>
	<b>ATTENTION</b>
	<p>The maintenance instructions given here are not designed for “do-it-yourself” repairs as special technical knowledge is required.</p>

## 14.1. General maintenance instructions

Sulzer units are reliable quality products, each being subjected to careful final inspection. Lubricated-for-life ball bearings, together with monitoring devices, ensure optimum reliability provided that the unit has been connected and operated in accordance with the operating instructions.

Should, nevertheless, a malfunction occur, do not improvise but ask your Sulzer customer service department for assistance.

This applies particularly if the unit is continually switched off by the current overload in the control panel, by the thermal sensors/limiters of the thermo-control system, or by the seal monitoring system (DI).

Regular inspection and care is recommended to ensure a long service life. Service intervals vary for Sulzer units depending on installation and application. Contact your local Sulzer Service Center for more information. A maintenance contract with our Service Department will guarantee the best technical service.

The Sulzer service organisation would be pleased to advise you on any applications you may have and to assist you in solving any problems you may encounter.

When carrying out repairs, only original spare parts supplied by the manufacturer should be used. Sulzer warranty conditions are only valid provided repair work has been carried out in a Sulzer approved workshop, and original Sulzer spare parts have been used.

	<b>ATTENTION</b>
	Repair work on explosion-proof motors may only be carried out in authorized workshops by qualified personnel using original parts supplied by the manufacturer. Otherwise the Ex-approvals are no longer valid. Detailed technical information is available in the technical data sheet which can be downloaded from <a href="https://www.sulzer.com">https://www.sulzer.com</a>

### 14.1.1. Inspection intervals

**Inspection chamber:** The oil in the inspection chamber should be checked every 12 months. Change the oil immediately if it is contaminated by water, or if an alarm indicates seal failure. If it happens again shortly after the oil has been changed, please contact your local Sulzer Service Representative.

**Motor chamber:** The motor chamber should be inspected every 12 months to ensure it is free from moisture.

## 14.2. Shredding system

The shredding system is a wearing part, and as such may need to be replaced. A reduction in cutting performance can reduce the output. We recommend that the shredding system is inspected regularly. This is particularly so if sewage containing sand is being pumped. Regular inspection and care is recommended to ensure a long service life.

The Sulzer Service Organisation would be pleased to advise you on any applications you may have and to assist you in solving your pumping problems.

## 14.3. Lubricant filling and changing

The motor chamber (Piranha-PE), and the seal chamber between the motor and the hydraulic section (Piranha-PE & Piranha-S), have been filled at manufacture.

An oil change is only necessary:

- At specified service intervals (for details contact your local Sulzer Service Centre).
- If the DI leakage sensor detects an ingress of water into the seal chamber or motor chamber.
- After repair work that requires draining of the oil.
- If the pump is being taken out of service the oil should be changed before storage.



### 14.3.1. Drain and fill the seal chamber

#### Procedure

1. Place a cloth over the plug screw to contain any possible spray of oil as the pump de-pressurises.
2. Loosen the plug screw enough to release any pressure that may have built-up, and re-tighten.
3. Place the pump in a horizontal position on a waste oil sump with the drain hole underneath.
4. Remove the plug screw and seal ring from the drain hole.
5. After the oil is fully drained rotate the pump so that the drain hole is positioned to the top.
6. Select the required volume of oil from the oil-fill quantities table and slowly fill through the drain hole.
7. Apply Bondloc B577 and refit the plug screw and seal ring.

#### Related concepts

[General design features](#) on page 11

## 14.4. Oil quantities (liters)

Table 13.



Piranha	Motor	Seal chamber
S	S10/4, S10/4W, S20/2, S20/2W, S26/2W, S30/2, S26/2W HH	0.51
PE	PE25/2W-C, PE28/2-C, PE35/2-C, PE35/2W-C, PE45/2-C, PE45/2W-C	0.43
	PE80/2-E, PE100/2-E, PE110/2-E, PE125/2-E	0.68

**Specification:** White mineral VG8 - VG10

## 14.5. Bottom plate adjustment

At manufacture, the bottom plate is fitted to the volute with the correct clearance gap set between the impeller and the bottom plate. Piranha-S HH has an inner second impeller with a diffuser attached to the volute. The bottom plate is subsequently attached to the diffuser.

### 14.5.1. Re-setting the clearance gap following wear

	 <b>CAUTION</b>
	Do not rotate by gripping with your hand, the shredding rotor has sharp edges.

### 14.5.1.1. Piranha-S and Piranha-PE

#### About this task

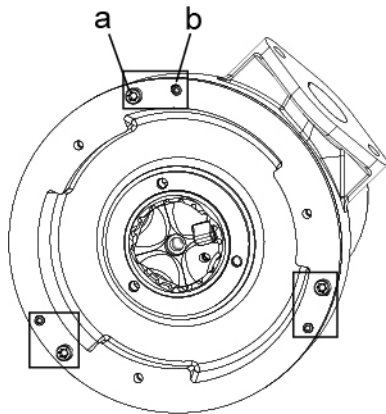

Piranha-S

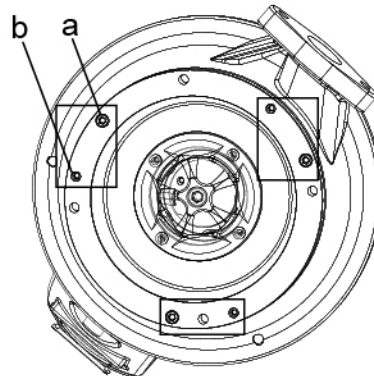

Piranha-PE

#### Procedure

1. Remove the three securing screws (a) and loosen the three adjusting screws (b).
2. Tap the bottom plate down fully against the impeller and volute.
3. Tighten the adjusting screws gradually until the impeller is lightly rubbing against the bottom plate when rotated by using a hex wrench in the fixing screw.
4. Apply Bondloc B242 to the securing screws, refit and tighten fully.

### 14.5.1.2. Piranha-S HH

#### About this task

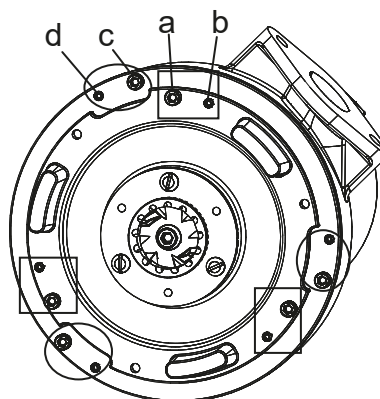

Piranha-S HH



#### NOTE

The gap between the inner impeller and diffuser must be adjusted before the gap between the outer impeller and the bottom plate is adjusted.

**Procedure**

1. Loosen the three securing screws (a) and the three adjusting screws (b).
2. Remove the three securing screws (c) and loosen the three adjusting screws (d).
3. Tap the diffuser down fully against the impeller and volute.
4. Tighten the adjusting screws gradually until the impeller is lightly rubbing against the difuser when rotated by using a hex wrench in the fixing screw.
5. Apply Bondloc B242 to the securing screws, refit and tighten fully.
6. To adjust the bottom plate follow the procedure for Piranha-S and Piranha-PE.

## 14.6. Bearings and mechanical seals

Piranha pumps are fitted with lubricated-for-life ball bearings. Shaft sealing is by means of double mechanical seals (Piranha-PE), and mechanical seal / lip seal (Piranha-S).

	ATTENTION
Once removed, bearings and seals must not be re-used, and must be replaced with genuine Sulzer spare parts in an approved workshop.	

## 14.7. Changing of the power cable



	 <b>DANGER</b>
The power cable must be replaced by the manufacturer, its service agent or a similar qualified person, in strict adherence to relevant safety regulations.	

**Piranha-PE:** To facilitate quick and easy changing or repair of the power cable, the connection between the cable and motor is by means of an integrated 10-pole terminal block.

## 14.8. Clearing pump blockage

### 14.8.1. Instructions for operator

The operator should only attempt to unblock the pump by re-setting the overload reset button or MCB on the control panel. The initial start force may be enough to displace any clogged material. If the pump continues to trip out on restart then a qualified service agent must be called.

	 <b>DANGER</b>
<p><b>Dangerous voltage</b></p> <p>To carry out the procedure above safely the control panel must not need to be opened to do so. The overload reset button or MCB must therefore be an externally mounted design.</p>	

## 14.8.2. Instructions for service personnel

### About this task



	 <b>DANGER</b>
	The pump must be isolated from the power supply before removing it from the installation.

	<b>ATTENTION</b>
	Adequate personal protective equipment must be worn at all times.

	<b>ATTENTION</b>
	Lifting safety regulations must be adhered to when lifting the pump.

### Procedure

1. Ensure that the pump is secured so that it cannot topple or roll over.
2. Use pump pliers to check for rags etc in the volute inlet and discharge.

	 <b>CAUTION</b>
	Never use fingers, even in gloves, to check around the volute internally due to the danger of something sharp piercing the gloves and skin.



3. Remove the bottom plate and cutting ring and clear out any debris with a pliers
4. If the impeller is still jammed from behind then the impeller has to be removed
5. The impeller and bottom plate should be checked for impact and wear damage.
6. Once the debris has been cleared out the impeller is refitted and should rotate freely by hand.

	<b>ATTENTION</b>
	Apply Bondloc B242 to the securing screw.

7. Refit the bottom plate and cutting ring.

	<b>ATTENTION</b>
	The gap between the impeller and bottom plate must be checked and adjusted if necessary. This is important as a measure to help prevent future blockages.

8. Reconnect the pump to the power source and dry run to check audibly for bearing or other mechanical damage.

	 <b>CAUTION</b>
Secure the pump so it cannot roll or fall on starting, and do not stand near the pump or directly in front of the pump discharge.	

**Related concepts**

[Personal protective equipment](#) on page 7

[Lifting](#) on page 17

[Bottom plate adjustment](#) on page 33

## 15. Cleaning

If the pump is used for transportable applications, then in order to avoid deposits of dirt and encrustation it should be cleaned after each usage by pumping clear water. In the case of fixed installation, we recommend that the functioning of the automatic level control system be checked regularly. By switching the selection switch (switch setting "HAND") the sump will be emptied. If deposits of dirt are visible on the floats then these should be cleaned. After cleaning, the pump should be rinsed out with clear water and a number of automatic pumping cycles carried out.



## 16. Troubleshooting guide

**Table 14.**

Fault	Cause	Fix
Pump does not run	Leakage sensor shutdown	Check for loose or damaged oil plug, or locate and replace faulty mechanical seal / damaged o-rings. Change oil. <sup>1)</sup>
	Air lock in volute	Shake or raise and lower the pump repeatedly until resulting air bubbles no longer appear at surface level.
	Level control override	Check for float switch that is faulty or tangled and held in OFF position in sump.
	Impeller jammed.	Inspect and remove jammed object. Check gap between impeller and bottom plate and adjust if necessary.
	Gate valve closed, non-return valve blocked.	Open gate valve, clean blockage from non-return valve.
Pump switching on/off intermittently	Temperature sensor shutdown.	Motor will restart automatically when pump cools down. Check thermal relay settings in control panel. Check for impeller blockage. If none of above, a service inspection is required. <sup>1)</sup>
Low head or flow	Wrong direction of rotation.	Change rotation by interchanging two phases of the power supply cable.
	Gap too wide between impeller and bottom plate	Reduce gap.
	Gate valve partially open.	Open valve fully.

*table continued*

Fault	Cause	Fix
Excessive noise or vibration	Defective bearing.	Replace bearing. <sup>1)</sup>
	Clogged impeller.	Clear the pump blockage to remove and clean hydraulics.
	Wrong direction of rotation.	Change rotation by interchanging two phases of the power supply cable.
<sup>1)</sup> Pump must be taken to approved workshop.		

	 <b>CAUTION</b>
	<p>Before commencing any inspection or repair work the pump should be completely disconnected from the mains by a qualified person and care should be taken that it cannot be inadvertently switched back on.</p>

**Related concepts**

[Bottom plate adjustment](#) on page 33

[Instructions for operator](#) on page 35

**Related tasks**

[Instructions for service personnel](#) on page 36

## 17. Company details

Address: Sulzer Pump Solutions Ireland Ltd. Clonard Road, Wexford, Ireland

Telephone: +353 53 91 63 200

Website: [www.sulzer.com](http://www.sulzer.com)