

SPARE PARTS LIST/ERSATZTEILLISTE/LISTE DE PIÈCES DE RECHANGE

AS 1030 S22/4 50Hz Std. & Ex

Valid from Serial Number: 100 -

Page :
 Issue of : 20/10/11
 Supersedes Issue :
 Issue No. : 01,02
 Drawing ref. Nr. : ANS12090-00

Pos. No.	Part No.	Kit	Qty	Description	Benennung	Designation	Dimensions /Din	Comments	Price
1	31005034		1	Motorhousing	Motorgehäuse	Carcasse moteur			
2	11120468	AB	1	O-ring	O-ring	Joint torique	47X3 DIN 3770	Viton	
3	43025563		1	Cable	Kabel	Cable	4x1.5 Tecwater	10m	
3	43025569		1	Cable	Kabel	Cable	4x1.5 Tecwater	20m	
3	43025657		1	Cable	Kabel	Cable	4x1.5 Tecwater	30m	
3	43025535		1	Cable	Kabel	Cable	7x1.5 Tecwater	10m	
3	43025536		1	Cable	Kabel	Cable	7x1.5 Tecwater	20m	
3	43025537		1	Cable	Kabel	Cable	7x1.5 Tecwater	30m	
3	43025538			Cable	Kabel	Cable	7x1.5 Tecwater	40m	
3	43025539			Cable	Kabel	Cable	7x1.5 Tecwater	50m	
4	31325008		1	Cable cap	Kabeleinführung	Entree de cable	GG25 (Ø12)	Cable 4x1.5 Tecwater Cable 4x1.5	
4	31320140		1	Cable cap	Kabeleinführung	Entree de cable	GG25 (Ø20)	Cable 7x1.5 Tecwater Cable 4x1.5+3x0.5	
5	42015009		2	Washer	Scheibe	Rondelle	34X18x1.5		
6	11210243		4	Cylinder screw	Zylinderschraube	Vis à tête cylindrique	M8x25 DIN 912		
7	11530017		4	Spring washer	Federring	Rondelle	M8 Din 7980		
8	43075058	A	1	Cable seal	Kabdichtung	Joint de kabel	Ø34x11.5x29.5H	Cable 4x1.5	
8	43075056	B	1	Cable seal	Kabdichtung	Joint de kabel	Ø34x11.5x29.5H (viton)	Cable 4x1.5	
8	43075048	A	1	Cable seal	Kabdichtung	Joint de kabel	Ø34x16x29.5H	Cable 4x1.5+3x0.5 Cable 7x1.5 SO7RN-F OZ+	
8	43075057	B	1	Cable seal	Kabdichtung	Joint de kabel	Ø34x16x29.5H (viton)	Cable 4x1.5+3x0.5 Cable 7x1.5 SO7RN-F OZ+	
8	43075049	A	1	Cable seal	Kabdichtung	Joint de kabel	Ø34x16.8x29.5H	Cable 7x1.5 TL07RN-F	
8	43075028	A	1	Cable seal	Kabdichtung	Joint de kabel	Ø34x13.8x29.5H	Cable 7x1.5 Tecwater	
8	43075068	B	1	Cable seal	Kabdichtung	Joint de kabel	Ø34x16.8x29.5H (Viton)	Cable 7x1.5 TL07RN-F	
8	43075034	B	1	Cable seal	Kabdichtung	Joint de kabel	Ø34x13.8x29.5H (Viton)	Cable 7x1.5 Tecwater	
8	43075058	A	1	Cable seal	Kabdichtung	Joint de kabel	Ø34x11.5x29.5H	Cable 4x1.5 Tecwater Cable 4x1.5	
9	12180044		4	Butt connector	St.verbinder	Connecteur			
10	11060006		1	Support Washer	Tragscheibe	Rondelle	25X35X2 Din 988		
11	11020006		1	Ball bearing	Kugellager	Roulement à billes	3205 B. DIN 628		
12	11120817	A	1	O-ring	O-ring	Joint torique	160X3 DIN 3771		
12	11120870	B	1	O-ring	O-ring	Joint torique	160X3 DIN 3771	Viton	
13	11080010		1	Circlip	Sicherungsring	Circlip	Ø52x2.0 DIN 472		
14	11110001		1	Mechanical seal	Gleitringdichtung	Garniture mecanique	20mm		
14	11110149		1	Mechanical seal	Gleitringdichtung	Garniture mecanique	20mm	Viton	
15	11470072		1	Washer	Scheibe	Rondelle	Ø8.4 DIN 9021		
16	11200230		1	Cylinder screw	Zylinderschraube	Vis à tête cylindrique	M8x16 DIN 933		
17	11470072		3	Washer	Scheibe	Rondelle	Ø8.4 DIN 9021		
18	11210243		3	Cylinder screw	Zylinderschraube	Vis à tête cylindrique	M8x25 DIN 912		
19	14990008		1	Shackle	Schäkel	Manille			

SPARE PARTS LIST/ERSATZTEILLISTE/LISTE DE PIÈCES DE RECHANGE

AS 1030 S22/4 50Hz Std. & Ex

Valid from Serial Number: 100 -

Page :
 Issue of : 20/10/11
 Supersedes Issue :
 Issue No. : 01,02
 Drawing ref. Nr. : ANS12090-00

Pos. No.	Part No.	Kit	Qty	Description	Benennung	Designation	Dimensions /Din	Comments	Price
20	11010017		1	Ball bearing	Kugellager	Roulement à billes	6204 ZR.C3 DIN 625		
21	65005499		1	Stator	Wicklung	Stator	230/3/50		
21	65005500		1	Stator	Wicklung	Stator	400/3/50		
21	65005501		1	Stator	Wicklung	Stator	500/3/50		
24	65015084		1	Rotor with shaft	Rotor mit Welle	Rotor avec arbre	1.4021		
24	65015085		1	Rotor with shaft	Rotor mit Welle	Rotor avec arbre	1.4401		
25	11130003	AB	1	Seal ring	Dichtung	Rondelle joint	6x10 DIN 7603		
26	11210253		1	Cylinder screw	Zylinderschraube	Vis à tête cylindrique	M6x10 DIN 912		
27	11490020	AB	1	Seal washer	Verschlußscheibe	Rondelle joint	DIN 470		
28	11070007		1	Circlip	Sicherungsring	Circlip	Ø25X1.2 Din 471		
29	11530018		3	Spring washer	Federring	Rondelle	M10 Din 7980		
30	11210251		3	Cylinder screw	Zylinderschraube	Vis à tête cylindrique	M10X50 DIN912		
31	31155036		1	Bearing lid	Lager deckel	Couvercle palier	GG20	Std.Europe/USA	
31	31155024		1	Bearing lid	Lager deckel	Couvercle palier	GG20	Std./EX EECS	
32	11090009	AB	1	Lip seal	Wellendichtung	Joint à levres	20X52X10 DIN 3760		
33	11030046		0.56	Oil	Öl	Huile			
34	11070005		1	Circlip	Sicherungsring	Circlip	Ø20X1.2 DIN 471		
35	11630128		1	Impeller key	Paßfeder	Clavette	6x6x10 DIN 6885		
36	35075217		1	Impeller	Lauftrad	Roue	Ø205		
37	31055062		1	Volute	Kreiselkammer	Corps de pompe			
38	31060585		1	Bottom plate	Bodenplatte	Plaque de base			
38	31065021		1	Bottom plate	Bodenplatte	Plaque de base		FHA	
39	11650001	AB	1	Seal washer	Verschlußscheibe	Rondelle joint	M8		
40	11260100		1	Cylinder screw	Zylinderschraube	Vis à tête cylindrique	M8X10 Din85		
41	11260104		1	Cylinder screw	Zylinderschraube	Vis à tête cylindrique	M5X10 DIN 85		
42	11500003		1	Locking washer	Klemmscheibe	Rondelle-frein			
43	12180014		1	Cable shoe	Flachsteckhülse	Cosse-câble			
44	43070326		1	Seal for DI	Dichtung für DI	Joint pour DI			
45	12180144		1	Round plug	Rundstecker	Fiche rond			
46	42130403		1	DI-probe	DI-electrode	Sonde DI			
47	41425032		1	Bracket	Haltewinkel	Butée			
48	11260091		1	Cylinder screw	Zylinderschraube	Vis à tête cylindrique	M5X12 DIN85		
49				Not available	nicht lieferbar	pas disponible			
50	12180144		1	Round plug	Rundstecker	Fiche rond			
51	42135000		1	DI-probe	DI-electrode	Sonde DI			
52	11080027		1	Circlip	Sicherungsscheibe	Circlip	Ø7 DIN 6799		
53	43070326		1	Seal for DI	Dichtung für DI	Joint pour DI			
54	11060014		1	Support Washer	Tragscheibe	Rondelle	42X52X2.5 Din 988		
55	11100066		1	Mechanical seal	Gleitringdichtung	Garniture mecanique	20mm		
56	11070006		1	Circlip	Sicherungsring	Circlip	Ø20X1.2 Din 471		
	61195073	A	1						
	61195077	B	1				Viton		

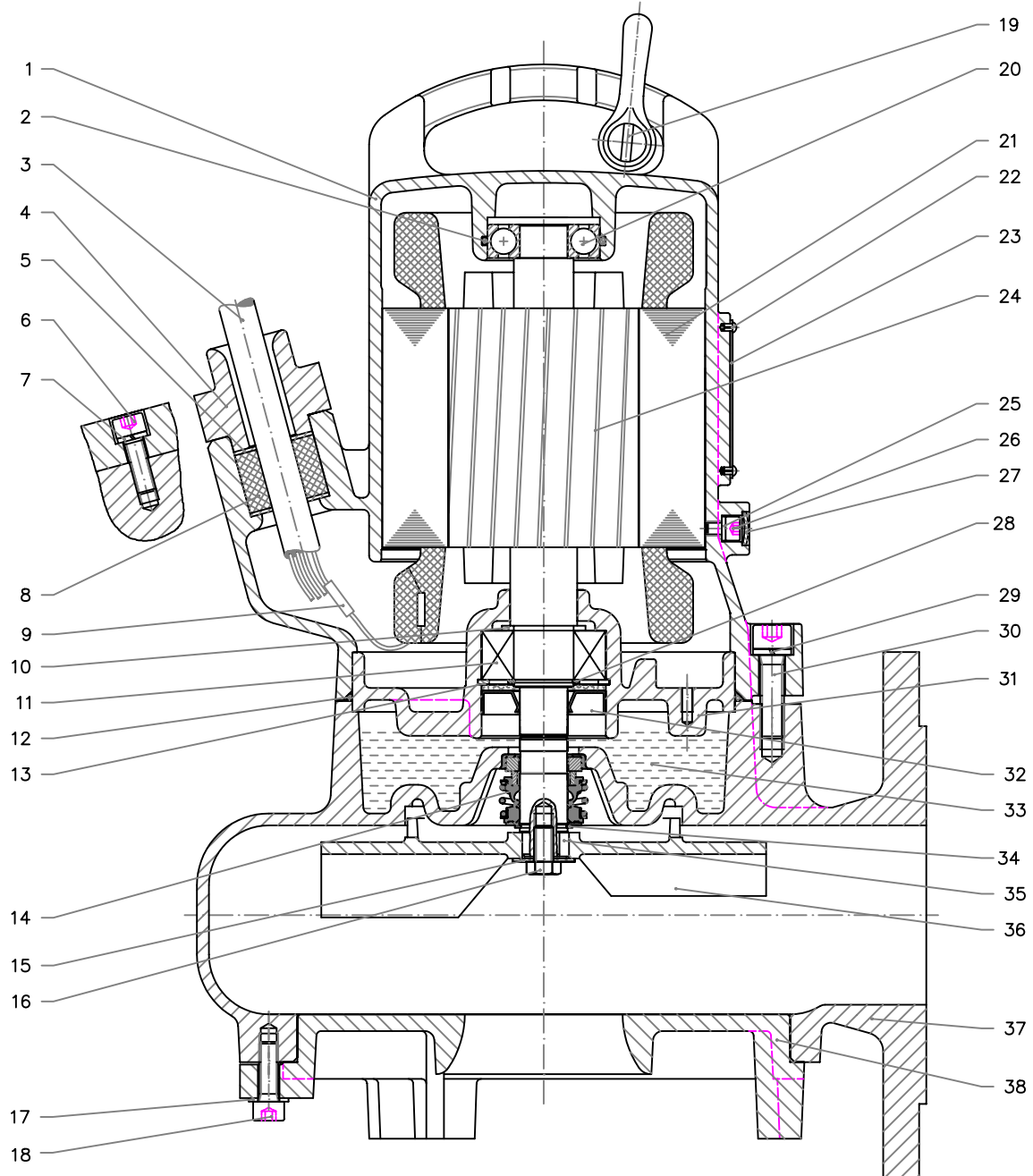

DI (OPTIONAL)
Std. Euro/USA

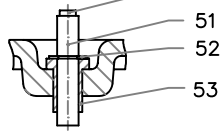

2nd Mech. seal

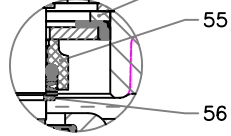

DI (OPTIONAL)
EX EECS

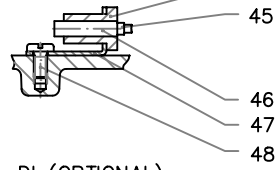

DI (OPTIONAL)
FM

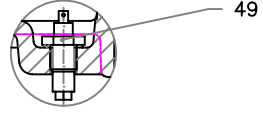

OIL SCREW

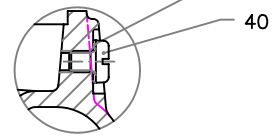

EARTH CONNECTION

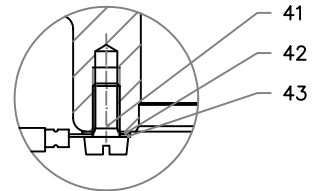

 <p>— A company in the ABB Group</p>	<p>SPARE PARTS LIST / ERSATZTEILLISTE LIST DE PIÉCES DE RECHANGE</p>	<p>AN-S 12.90 -00</p>
	<p>AS1030 M22-4 (50Hz) AS1030 M25-4 (60Hz)</p>	<p>CAD CODE: G:\DWG\AS12090</p>
	<p>Product Center: IEM</p>	<p>DATE/NAME 13.01.00 C.QUIRKE</p>
	<p>Techical changes reserved Änderungen vorbehalten Sans réserve de modification</p>	