

SULZER

Original instructions

**Installation, operation and maintenance instructions
Submersible Sewage Pump Type ABS XFP PE1 - PE3**





Table of contents













1. Important notice	4
2. Symbols and notices	4
3. General	5
3.1. Hydraulics.....	5
3.2. Intended use and application.....	5
3.3. Identification code.....	6
4. Performance range	7
5. Safety	8
5.1. Personal protective equipment.....	8
6. Use of motors in Ex zones	8
6.1. Explosion-proof approvals.....	8
6.2. General information.....	8
6.3. Special conditions for safe use.....	9
6.4. Operation of explosion-proof submersible pumps with frequency inverter in hazardous areas (ATEX Zone 1 and 2).....	9
6.5. Operation of explosion-proof submersible pumps in wet well installation.....	9
7. Technical data	9
7.1. Nameplates.....	9
7.1.1. Nameplate drawings.....	10
8. General design features	11
8.1. Design features PE1 & PE2.....	12
8.2. Design features PE3 (version with cooling jacket).....	13
9. Weights	14
9.1. XFP - 50 Hz.....	15
9.2. XFP - 60 Hz.....	17
9.3. Chain (EN 818)*.....	20
10. Lifting, transport and storage	21
10.1. Lifting.....	21
10.2. Transport.....	21
10.2.1. Vertical lifting.....	21
10.2.2. Horizontal lifting.....	22
10.3. Storage.....	23
10.3.1. Moisture protection of motor connection cable.....	23
11. Setup and installation	24
11.1. Equipotential bonding.....	24
11.1.1. Connection points.....	25
11.2. Discharge line.....	25
11.3. Installation types.....	26
11.3.1. Submerged in a concrete sump.....	26
11.3.2. Dry-installed.....	29
11.3.3. Transportable.....	31
11.3.4. Venting of the volute.....	32
12. Electrical connection	32
12.1. Seal monitoring.....	33
12.2. Temperature monitoring.....	35
12.2.1. Temperature sensor bimetal.....	35

12.2.2. Temperature sensor PTC.....	36
12.3. Operation with variable frequency drive (VFD).....	37
12.4. Wiring diagrams.....	37
13. Commissioning.....	38
13.1. Types of operation and frequency of starting.....	39
13.2. Direction of rotation.....	39
13.2.1. Checking direction of rotation.....	39
13.2.2. Changing direction of rotation.....	40
14. Maintenance and service.....	40
14.1. General maintenance instructions.....	41
14.1.1. Inspection intervals.....	41
14.2. Lubricant changing (PE1 & PE2).....	41
14.2.1. Drain and fill the seal chamber (PE1 & PE2).....	42
14.3. Lubricant changing (PE3 - version without cooling jacket).....	43
14.3.1. Drain and fill the inspection and seal chambers (PE3 - version without cooling jacket).....	44
14.4. Coolant changing (PE3 - version with cooling jacket).....	45
14.4.1. Drain and fill the cooling system (PE3 - version with cooling jacket).....	45
14.5. Oil and glycol quantities (liters).....	46
14.6. Bottom plate adjustment (CB & CP).....	47
14.6.1. Adjust the bottom plate (CB & CP).....	48
14.7. Bearings and mechanical seals.....	49
14.8. Changing the power cable.....	49
14.9. Clearing pump blockage.....	49
14.9.1. Instructions for operator.....	49
14.9.2. Instructions for service personnel.....	49
14.10. Cleaning.....	50
15. Troubleshooting guide.....	51
16. Company details.....	52

1. Important notice

	NOTE
	The original version of this document is in English. All other languages are a translation of the original. In case of a discrepancy, the English version will prevail.
	NOTE
	The layout and wording of the online version of this manual may vary from the printed version. The same information is provided in both.

2. Symbols and notices

	 DANGER
	Presence of dangerous voltage
	 DANGER
	Danger of an explosion occurring.
	 WARNING
	Hot surface - danger of burn or injury.
	 WARNING
	Hot liquid - danger of burn or injury.
	 CAUTION
	Non-compliance may result in personal injury.
	ATTENTION
	Non-observance may result in damage to the unit or negatively affect its performance.
	NOTE
	Important information for particular attention.

3. General

!	NOTE
	Sulzer reserves the right to alter specifications due to technical developments.

3.1. Hydraulics

Table 1.

Submersible sewage pump type ABS XFP:							
PE1	PE2	PE3		PE1	PE2	PE3	
50 Hz				60 Hz			
80C-CB1	80E-CB1	100G-CB1	155G-CB2	80C-CB1	80E-CB1	100G-CB1	105J-CB2
80C-VX	81E-VX	100G-VX	200G-CB1	80C-VX	85E-VX	101G-CB1	155J-CB2
81C-CB1	85E-VX	101G-CB1	205G-CB2	81C-VX	86E-CB2	101G-VX	206J-CB2
81C-VX	86E-VX	101G-VX	206G-CB2	85C-VX	86E-VX	150G-CB1	255J-CB2
85C-VX	100E-CB1	105G-CB2	105J-CB2	100C-CB1	100E-CB1	150G-CP	305J-CB2
86C-CB2	100E-VX	107G-CB2	155J-CB2	100C-VX	100E-VX	155G-CB2	
100C-CB1	100E-CP	150G-CB1	206J-CB2		100E-CP	200G-CB1	
100C-VX	105E-VX	150G-VX	255J-CB2		105E-VX	205G-CB2	
	150E-CB1	150G-CP	305J-CB2		150E-CB1	206G-CB2	
	151E-CB2				151E-CB2		



3.2. Intended use and application

XFP pumps have been designed for economic and reliable pumping in commercial, industrial and municipal installations and are suitable for pumping of the following liquids:

- Clean water and wastewater.
- Sewage containing solids and fibrous material.
- Sewage with sludge and high content of rags.
- Industrial raw water and wastewater.
- Various types of industrial effluents.
- Municipal combined sewage and storm water systems.
- Seawater applications with cathodic protection and IM5 coating (consult Sulzer for advice).

XFP-CP (Chopper) pumps have been designed for the pumping of heavily contaminated commercial, industrial, municipal and agricultural wastewater, sewage and sludge, in wet well installations.

These units must not be used in certain applications e.g. operating within flammable, combustible, chemical, corrosive, or explosive liquids.

	ATTENTION
	The maximum allowable temperature of the medium pumped is 40 °C / 104 °F.
	ATTENTION
	Leakage of lubricants could result in pollution of the medium being pumped.
	ATTENTION
	Always consult with your local Sulzer representative for advice on approved use and application before installing the pump.

3.3. Identification code

Table 2.

e.g. XFP-PE1-100C-CB1.5-PE28_4C-FM	
Hydraulics:	Motor:
<p>XFP = Product range</p> <p>PE1 = Product</p> <p>10 = Discharge outlet DN (cm)</p> <p>0 = Hydraulic type</p> <p>C = Volute opening: C = 222 / 9; E = 265 / 10; G = 335 / 13 (dia. mm / ins)</p> <p>CB = Impeller type: CB = Contrablock; VX = Vortex</p> <p>1 = Number of impeller vanes</p> <p>5 = Impeller size</p>	<p>PE = Premium Efficiency</p> <p>28 = Motor power P₂ kW x 10</p> <p>4 = Number of poles</p> <p>C = Volute opening : C = 222 / 9; E = 265 / 10; G = 335 / 13 (dia. mm / ins)</p> <p>FM = Approval</p>

4. Performance range

Figure 1. Contrablock impeller 50 Hz / 60 Hz

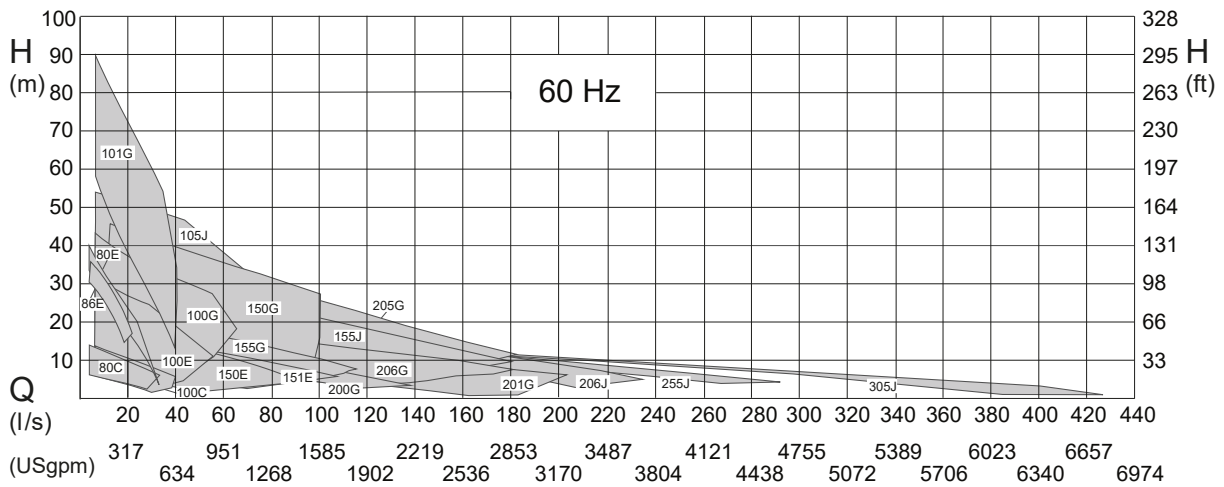
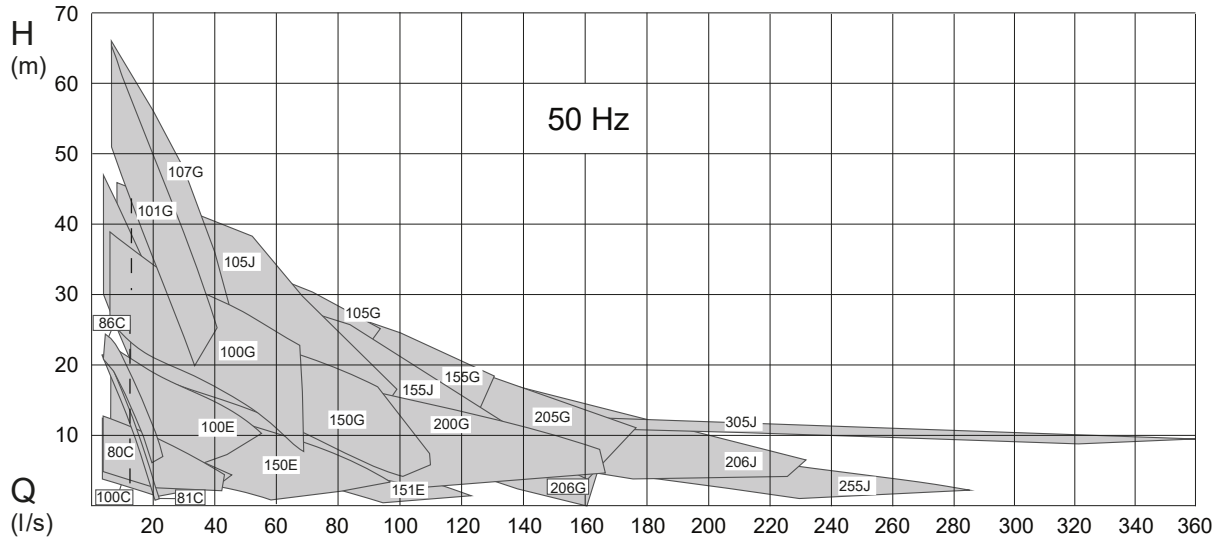
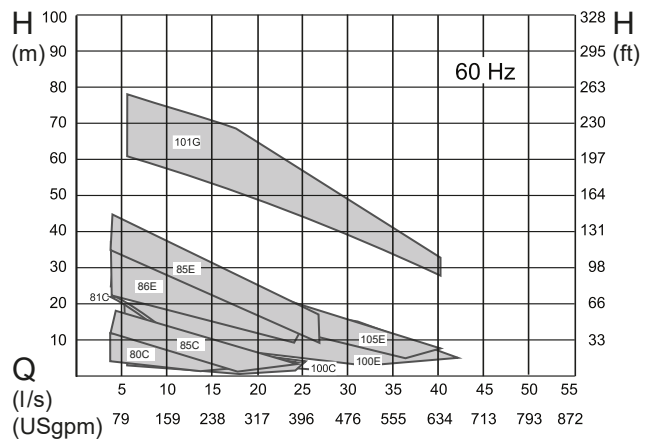
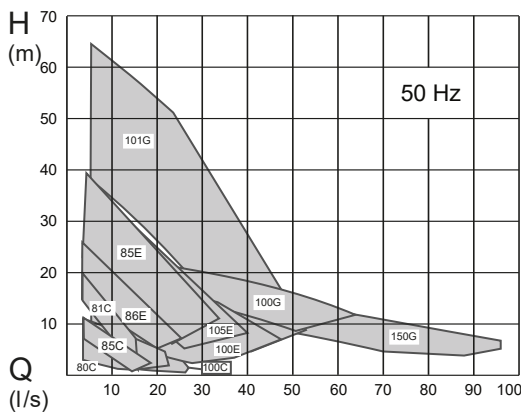



Figure 2. Vortex impeller 50 Hz / 60 Hz



5. Safety

The general and specific health and safety guidelines are described in detail in the "Safety Instructions for Sulzer Products Type ABS" booklet. If anything is not clear or you have any questions as to safety make certain to contact the manufacturer Sulzer.

XFP pumps are not to be used by persons (including children) with reduced physical, sensory or mental capabilities, or lack of experience and knowledge. Children must be supervised so that they cannot play with the appliance.

	 CAUTION
	Under no circumstances place a hand inside the suction or discharge openings unless the pump is completely isolated from the power supply.

5.1. Personal protective equipment

Submersible electrical units can present mechanical, electrical, and biological hazards to personnel during installation, operation, and service. It is obligatory that appropriate personal protective equipment (PPE) is used. The minimum requirement is the wearing of safety glasses, footwear, and gloves. However, an on-site risk assessment should always be carried out to determine if additional equipment is required e.g. safety harness, breathing equipment etc.



6. Use of motors in Ex zones

6.1. Explosion-proof approvals

Explosion-proof as standard, in accordance with international standards ATEX 2014/34/EU [Ex II 2G Ex h db IIB T4 Gb], and for 60 Hz US with FM and CSA.



	NOTE
	Ex protection method type "c" (constructional safety) and type "h" (protection by encapsulation and is achieved by liquid immersion of the hydraulic parts when installed and commissioned at the customers site) in accordance with EN ISO 80079-36, EN ISO 80079-37 are used.

6.2. General information

	 DANGER
	Danger of explosion In hazardous areas care must be taken that during switching on and operation of the unit, the hydraulic section is filled with water (dry installation) or alternatively is submerged (wet well installation).

1. The equipment must never run dry during operation. The volute must be filled with liquid during operation. Dry running during service and inspection is only permitted outside the classified area.
2. Explosion-proof submersible units may only be operated with the thermal sensing system connected.
3. Temperature monitoring of explosion-proof submersible units must be carried out by bi-metallic temperature limiters or thermistors according to DIN 44 082 connected to a suitable release device which is certified in accordance with EC directive 2014/34/EU and FM 3610.

4. Float switches, and any external seal monitoring (leakage sensor (DI), must be connected via an intrinsically safe electrical circuit, Protection Type EX (i), in accordance with IEC 60079-11 and FM 3610.
5. In the event that the unit is to be operated in explosive atmospheres using a variable speed drive (VFD), please contact your local Sulzer representative for technical advice regarding the various approvals and standards concerning thermal overload protection.

	ATTENTION
	Some units are approved for use in hazardous locations, and are fitted with a nameplate containing technical data and Ex certification. Repair work on Ex rated units must be carried out in Ex approved workshops by qualified personnel, using original parts supplied by the manufacturer. Otherwise it must no longer be used in hazardous locations, and where fitted, the Ex nameplate must be removed and replaced by a standard version.
	NOTE
	All local regulations and guidelines must be followed without exception.

6.3. Special conditions for safe use

These motor units are not intended for user service or repair, any operation that may affect the explosion protection characteristics should be referred to the manufacturer.

Repairs on flameproof joints may only be performed in accordance with the manufacturer's design specifications. Repair on the basis of the values in tables 2 and 3 of EN 60079-1 or annex B and D of FM 3615 is not permitted.

6.4. Operation of explosion-proof submersible pumps with frequency inverter in hazardous areas (ATEX Zone 1 and 2)

Machines designated as Ex machines may never, without exception, be operated using a mains frequency that is greater than the maximum of 50 Hz or 60 Hz as indicated on the nameplate.

6.5. Operation of explosion-proof submersible pumps in wet well installation

It must be ensured that the hydraulic of the Ex submersible pump is always fully submerged during start-up and operation!

7. Technical data

Maximum noise level ≤ 70 dB. In some types of installations it is possible that during operation the noise level of 70 dB(A) or the measured noise level may be exceeded.

Detailed technical information is available in the technical data sheet which can be downloaded from <https://www.sulzer.com>

7.1. Nameplates

Some units are approved for use in hazardous locations, and are fitted with a nameplate containing technical data and Ex certification. Repair work on Ex rated units must be carried out in Ex approved workshops by qualified personnel, using original parts supplied by the manufacturer. Otherwise it must no longer be used in hazardous locations, and where fitted, the Ex nameplate must be removed and replaced by a standard version.

We recommend that you record the data from the standard nameplate on the unit in the legend below, and maintain it as a source of reference for the ordering of spare parts, repeat orders and general queries.

Always state the type, item number and serial number in all communications.

7.1.1. Nameplate drawings

Figure 3. Standard nameplate

1.		2.	

- 1 PE1-3, CE, 50 Hz
- 2 PE1-3, US/CA, 60 Hz

Table 3.

Legend	Description	Data
Typ	Pump type	
Nr	Item No.	
Sn	Serial No.	
xx/xxxx	Production date (Week/Year)	
U_N	Rated voltage	V
I_N	Rated current	A
Ph	Number of phases	
Hz	Frequency	Hz
P1	Rated input power	kW / hp
P2	Rated output power	kW / hp
Cos φ	Power factor	pf
n / RPM	Speed	r/min / RPM
Weight / Wt	Weight	kg / lbs
Qmax	Maximum flow	m ³ /h / gpm
DN	Discharge diameter	mm / ins
Hmax	Maximum head	m / ft
Hmin	Minimum head	m / ft
∇ Max.	Maximum submergence depth	m / ft

table continued

Legend	Description	Data
Ø Imp	Impeller diameter	mm / ins
IE	Motor efficiency standard	
NEMA	NEMA code	Class

Figure 4. Ex nameplate

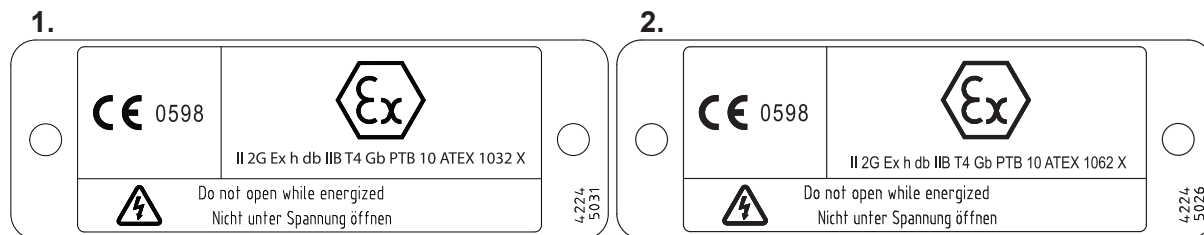

- 1 PE1 and PE2, 50 Hz
- 2 PE3, 50 Hz

8. General design features

XFP is a submersible sewage and wastewater pump with a Premium Efficiency motor.

The water-pressure-tight, encapsulated, flood-proof motor and the pump section form a compact, robust, modular construction.

8.1. Design features PE1 & PE2

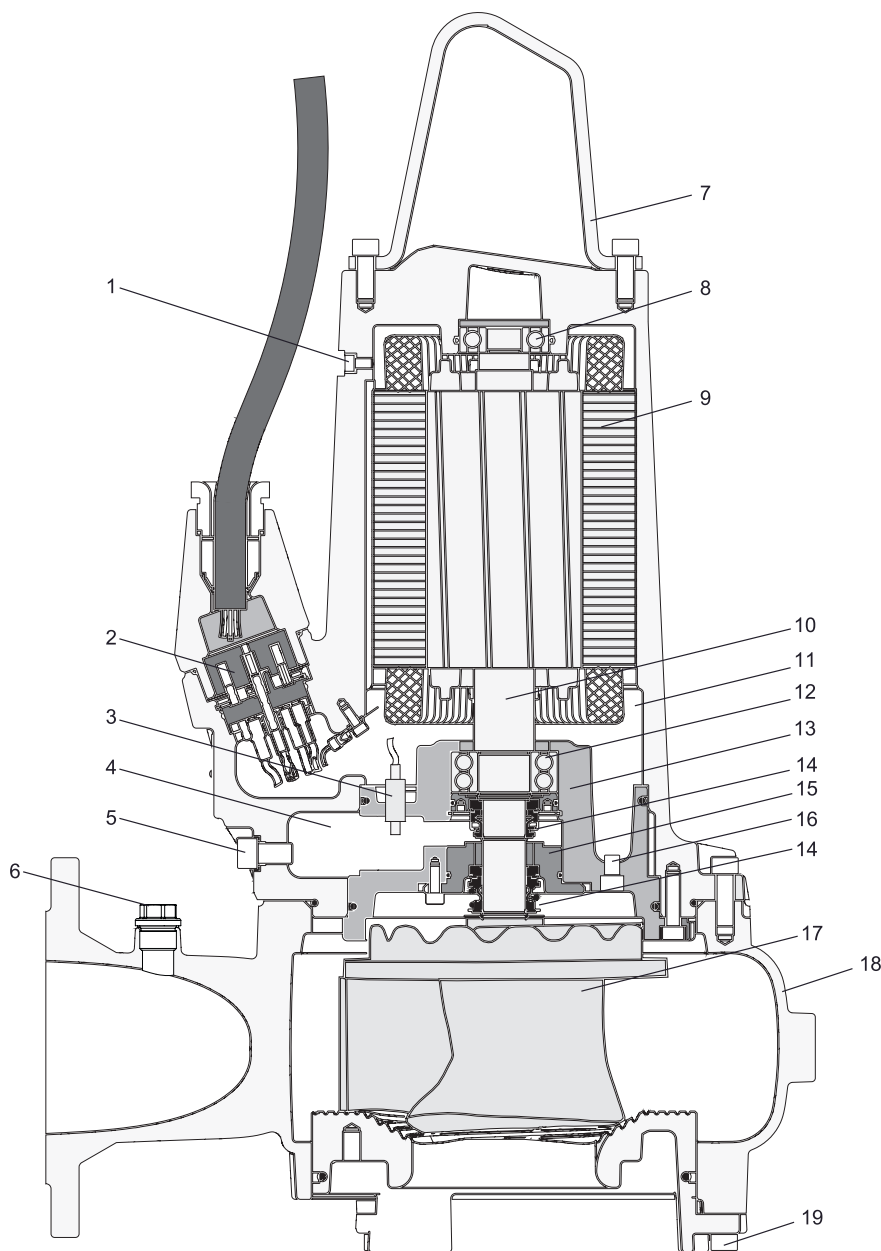

- 1. Pressure release screw
- 2. 10-pole terminal block
- 3. Leakage sensor (DI)
- 4. Seal chamber
- 5. Seal chamber drain plug /pressure test point
- 6. Venting plug
- 7. Stainless steel lifting hoop
- 8. Upper bearing - single row
- 9. Motor with thermal sensors
- 10. Stainless steel shaft

8. General design features

- 11. Motor chamber
- 12. Lower bearing - double row
- 13. Bearing housing
- 14. Mechanical seals
- 15. Seal holding plate
- 16. Motor chamber drain plug /pressure test point
- 17. Impeller - Contrablock
- 18. Volute
- 19. Bottom plate adjustment screw

8.2. Design features PE3 (version with cooling jacket)

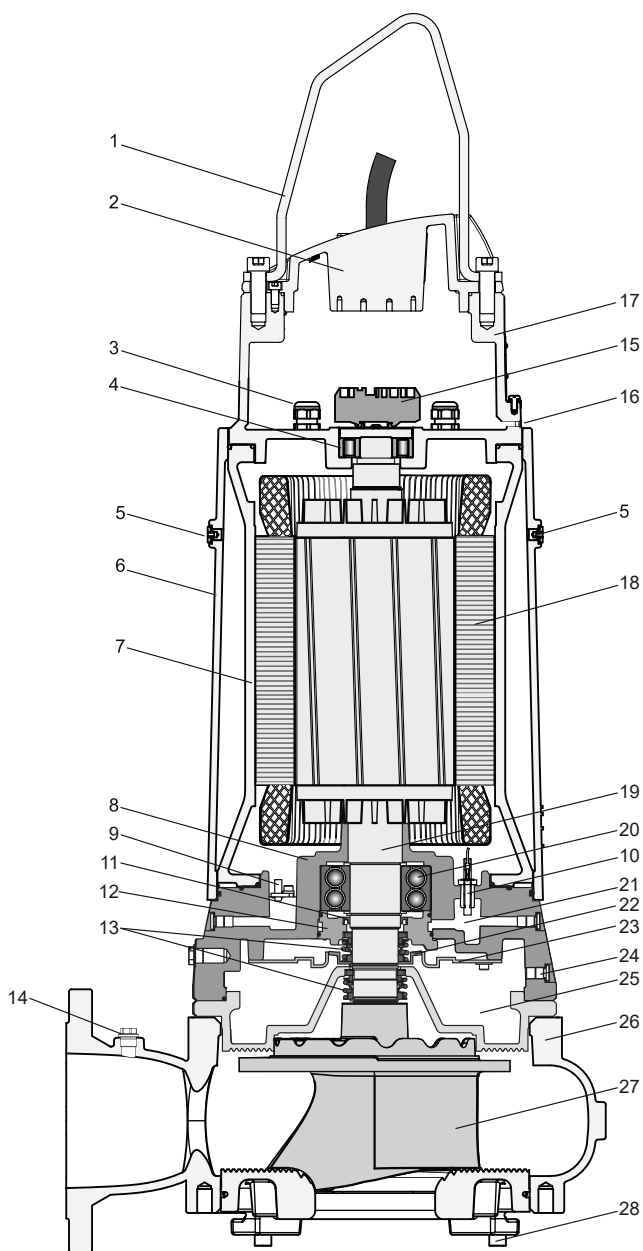

1. Stainless steel lifting hoop
2. Lid assembly
3. Cable gland
4. Upper bearing - cylindrical roller bearing
5. Coolant fill plug
6. Cooling jacket
7. Motor housing
8. Lower bearing housing
9. Leakage sensor (DI) 50 Hz
10. Leakage sensor (DI) 60 Hz
11. Lipseal
12. Seal holding plate
13. Mechanical seals
14. Venting plug
15. Terminal block
16. Pressure test point
17. Upper bearing housing
18. Motor with thermal sensors
19. Stainless steel shaft
20. Lower bearing - double row
21. Inspection chamber
22. Coolant impeller
23. Flow deflector
24. Coolant drain plug / pressure test point
25. Seal chamber
26. Volute
27. Impeller - Contrablock
28. Bottom plate adjustment screw

9. Weights

	NOTE
	Weight on nameplate is for pump and cable only.

9.1. XFP - 50 Hz

Table 4.

XFP (50 Hz)		Pedestal bracket and fasteners (kg)	Horizontal supports* (kg)	Transport- able pump stand (kg)	Cable** (kg)	Pump*** without cable (kg)
80C-CB1	PE22/4, 13/6	8	9	10	0.3	100 / n.a.
	PE29/4	8	9	10	0.3	110 / n.a.
80C-VX	PE15/4, 22/4, 29/4	8	2	10	0.3	100 / n.a.
80E-CB1	PE70/2	8	2	10	0.4	150 / n.a.
	PE110/2	8	2	10	0.5	170 / n.a.
81C-CB1	PE40/2	8	9	10	0.4	110 / n.a.
81C-VX	PE30/2	8	2	10	0.3	110 / n.a.
	PE40/2	8	2	10	0.4	110 / n.a.
81E-VX	PE70/2	8	3	10	0.4	130 / n.a.
	PE110/2	8	3	10	0.5	160 / n.a.
85C-VX	PE15/4	8	9	10	0.3	110 / n.a.
	PE22/4	8	9	10	0.3	120 / n.a.
85E-VX	PE70/2	8	9	10	0.4	170 / n.a.
	PE110/2	8	9	10	0.5	150 / n.a.
86C-CB2	PE30/2	8	9	10	0.3	122 / n.a.
	PE40/2	8	9	10	0.4	122 / n.a.
86E-VX	PE55/2	8	9	10	0.4	130 / n.a.
	PE70/2	8	9	10	0.4	150 / n.a.
100C-CB1	PE22/4, 29/4, 13/6	12	9	10	0.3	110 / n.a.
100C-VX	PE15/4	12	2	10	0.3	100 / n.a.
	PE22/4, 29/4	12	2	10	0.3	110 / n.a.
100E-CB1	PE40/4, 60/4	12	3	11	0.4	160 / n.a.
	PE75/4, PE90/4	12	3	11	0.5	180 / n.a.
100E-CP	PE60/4	12	n.a.	11	0.4	170 / n.a.
	PE75/4, PE90/4	12	n.a.	11	0.5	190 / n.a.
100E-VX	PE40/4	12	3	11	0.4	140 / n.a.
	PE60/4	12	3	11	0.4	150 / n.a.
	PE75/4, PE90/4	12	3	11	0.5	170 / n.a.

table continued

XFP (50 Hz)		Pedestal bracket and fasteners (kg)	Horizontal supports* (kg)	Transport- able pump stand (kg)	Cable** (kg)	Pump*** without cable (kg)
100G-CB1	PE110/4, 140/4	12	12	21	0.4	330 / 380
	PE160/4, 185/4	12	12	21	0.5	350 / 400
	PE220/4	12	12	21	0.4	360 / 410
100G-VX	PE110/4, 140/4	12	12	21	0.4	320 / 370
	PE160/4, 185/4	12	12	21	0.5	340 / 390
101G-CB1	PE150/2	19	10	16	0.4	340 / 380
	PE185/2	19	10	16	0.5	340 / 380
	PE250/2	19	10	16	0.5	350 / 390
101G-VX	PE150/2	19	12	21	0.4	330 / 370
	PE185/2	19	12	21	0.5	330 / 370
	PE250/2	19	12	21	0.5	340 / 380
105E-VX	PE70/2	12	12	21	0.4	160 / n.a.
	PE110/2	12	12	21	0.5	180 / n.a.
105G-CB2	PE220/4	12	12	21	0.4	410 / 450
	PE300/4	12	12	21	0.5	440 / 490
107G-CB2	PE150/2	19	10	16	0.4	340 / 380
	PE185/2	19	10	16	0.5	340 / 380
	PE250/2	19	10	16	0.5	350 / 390
150E-CB1	PE40/4, 30/6	17	3	11	0.4	160 / n.a.
	PE60/4	17	3	11	0.4	170 / n.a.
	PE75/4, PE90/4	17	3	11	0.5	190 / n.a.
150G-CB1	PE110/4, 140/4	20	12	21	0.4	340 / 380
	PE160/4, 185/4	20	12	21	0.5	370 / 400
	PE220/4	20	12	21	0.4	370 / 420
150G-CP	PE110/4	20	n.a.	21	0.4	320 / n.a.
150G-VX	PE110/4	20	12	21	0.4	330 / 380
	PE140/4	20	12	21	0.4	320 / 380
	PE160/4, 185/4	20	12	21	0.5	350 / 400
151E-CB2	PE49/4, 60/4	20	3	11	0.4	170 / n.a.
	PE75/4, PE90/4	20	3	11	0.5	190 / n.a.
155G-CB2	PE220/4	20	12	21	0.4	410 / 450
	PE300/4	20	12	21	0.5	440 / 490

table continued

XFP (50 Hz)		Pedestal bracket and fasteners (kg)	Horizontal supports* (kg)	Transportable pump stand (kg)	Cable** (kg)	Pump*** without cable (kg)
200G-CB1	PE110/4, 140/4	25	12	21	0.4	370 / 420
	PE160/4, 185/4	25	12	21	0.5	400 / 440
	PE220/4	25	12	21	0.4	410 / 460
	PE90/6	25	12	21	0.4	380 / 420
205G-CB2	PE220/4	25	12	21	0.4	430 / 480
	PE300/4	25	12	21	0.5	460 / 510
206G-CB2	PE185/6	25	12	21	0.4	450 / 500
	PE220/6	25	12	21	0.5	480 / 530
105J-CB2	PE220/4	19	17	50	0.5	412 / 472
	PE300/4	19	17	50	0.5	442 / 502
155J-CB2	PE220/4	28	17	50	0.5	420 / 470
	PE300/4	28	17	50	0.5	450 / 510
	PE185/6	28	17	50	0.5	445 / 505
	PE220/6	28	17	50	0.5	453 / 503
206J-CB2	PE300/4	39	17	56	0.5	487 / 547
	PE220/6	39	17	56	0.5	494 / 554
	PE185/6	39	17	56	0.5	486 / 546
255J-CB2	PE185/6	53	23	81	0.5	541 / 601
	PE220/6	53	23	81	0.5	549 / 609
305J-CB2	PE185/6	74	43	91	0.5	645 / 705
	PE220/6	74	43	91	0.5	653 / 713
* Includes adapter flange for XFP 80C-CB1 and XFP 100C-CB1. ** Weight per meter. *** Without / with cooling jacket						

9.2. XFP - 60 Hz

XFP (60 Hz)		Pedestal bracket and fasteners kg (lbs)	Horizontal supports* kg (lbs)	Transport- able pump stand kg (lbs)	Cable** kg (lbs)	Pump*** without cable kg (lbs)
80C-CB1	PE28/4, 35/4	8 (18)	9 (20)	10 (22)	0.2 (0.4)	110 (243) / n.a.
	PE20/6	8 (18)	9 (20)	10 (22)	0.1 (0.3)	120 (265) / n.a.
	PE28/4W	8 (18)	9 (20)	10 (22)	0.3 (0.5)	100 (221) / n.a.
	PE20/6W	8 (18)	9 (20)	10 (22)	0.2 (0.4)	120 (265) / n.a.
80C-VX	PE22/4, 35/4	8 (18)	2 (4)	10 (22)	0.1 (0.3)	110 (243) / n.a.
	PE18/4W	8 (18)	2 (4)	10 (22)	0.2 (0.4)	100 (221) / n.a.
	PE28/4W	8 (18)	2 (4)	10 (22)	0.3 (0.5)	100 (221) / n.a.
80E-CB1	PE125/2	8 (18)	2 (4)	10 (22)	0.3 (0.5)	180 (397) / n.a.
81C-VX	PE45/2	8 (18)	2 (4)	10 (22)	0.3 (0.5)	110 (243) / n.a.
85E-VX	PE 125/2	8 (18)	9 (20)	10 (22)	0.3 (0.5)	170 (375) / n.a.
	PE100/2	8 (18)	9 (20)	10 (22)	0.3 (0.5)	150 (331) / n.a.
85C-VX	PE35/4	8 (18)	2 (4)	10 (22)	0.2 (0.4)	120 (265) / n.a.
	PE28/4	8 (18)	2 (4)	10 (22)	0.2 (0.4)	120 (265) / n.a.
	PE22/4	8 (18)	2 (4)	10 (22)	0.1 (0.3)	120 (265) / n.a.
86E-CB2	PE80/2	8 (18)	9 (20)	10 (22)	0.3 (0.5)	165 (364) / n.a.
86E-VX	PE100/2	8 (18)	9 (20)	10 (22)	0.3 (0.5)	150 (331) / n.a.
	PE80/2	8 (18)	9 (20)	10 (22)	0.3 (0.5)	130 (287) / n.a.
100C-CB1	PE125/	8 (18)	3 (7)	10 (22)	0.3 (0.5)	160 (353) / n.a.
	PE28/4, 35/4	8 (18)	9 (20)	10 (22)	0.1 (0.3)	120 (265) / n.a.
	PE20/6	8 (18)	9 (20)	10 (22)	0.1 (0.3)	130 (287) / n.a.
	PE28/4W	8 (18)	9 (20)	10 (22)	0.3 (0.5)	120 (265) / n.a.
100C-VX	PE20/6W	8 (18)	9 (20)	10 (22)	0.2 (0.4)	130 (287) / n.a.
	PE22/4, 28/4, 35/4	12 (27)	2 (4)	10 (22)	0.1 (0.3)	110 (243) / n.a.
	PE18/4W	12 (27)	2 (4)	10 (22)	0.2 (0.4)	110 (243) / n.a.
100E-CB1	PE28/4W	12 (27)	2 (4)	10 (22)	0.3 (0.5)	110 (243) / n.a.
	PE45/4, 75/4	12 (27)	3 (7)	11 (24)	0.3 (0.5)	160 (353) / n.a.
	PE56/4	12 (27)	3 (7)	11 (24)	0.3 (0.5)	150 (331) / n.a.
	PE90/4,	12 (27)	3 (7)	11 (24)	0.3 (0.5)	180 (397) / n.a.
	PE105/4	12 (27)	3 (7)	11 (24)	0.3 (0.5)	190 (419) / n.a.
100E-CP	PE35/6	12 (27)	3 (7)	11 (24)	0.2 (0.4)	170 (375) / n.a.
	PE75/4	12 (27)	n.a.	11 (24)	0.3 (0.5)	160 (353) / n.a.

table continued

XFP (60 Hz)		Pedestal bracket and fasteners kg (lbs)	Horizontal supports* kg (lbs)	Transportable pump stand kg (lbs)	Cable** kg (lbs)	Pump*** without cable kg (lbs)
100E-VX	PE105/4	12 (27)	n.a.	11 (24)	0.3 (0.5)	190 (419) / n.a.
	PE45/4, 56/4	12 (27)	3 (7)	11 (24)	0.3 (0.5)	140 (309) / n.a.
	PE75/4	12 (27)	3 (7)	11 (24)	0.3 (0.5)	150 (331) / n.a.
100G-CB1	PE90/4, 105/4	12 (27)	3 (7)	11 (24)	0.3 (0.5)	170 (375) / n.a.
	PE130/4, 150/4	12 (27)	12 (27)	21 (46)	0.4 (0.9)	330 (728) / 370 (816)
	PE185/4, 210/4	12 (27)	12 (27)	21 (46)	0.5 (1.0)	350 (772) / 390 (860)
101G-CB1	PE250/4 ^{(1), (2)}	12 (27)	12 (27)	21 (46)	0.7 (2.0)	360 (794) / 410 (904)
	PE90/6(1	12 (27)	12 (27)	21 (46)	0.3 (0.5)	340 (750) / 390 (860)
	PE185/2, 200/2	19 (42)	10 (22)	16 (35)	0.5 (1.0)	320 (706) / 360 (794)
101G-VX	PE230/2	19 (42)	10 (22)	16 (35)	0.5 (1.0)	330 (728) / 370 (816)
	PE300/2	19 (42)	10 (22)	16 (35)	0.7 (2.0)	330 (728) / 370 (816)
105E-VX	PE125/2	12 (27)	9 (20)	10 (22)	0.4 (0.9)	170 (375) / n.a.
	PE100/2	12 (27)	9 (20)	10 (22)	0.3 (0.5)	150 (331) / n.a.
150E-CB1	PE230/2	19 (42)	12 (27)	21 (46)	0.5 (1.0)	330 (728) / 380 (838)
	PE300/2	19 (42)	12 (27)	21 (46)	0.7 (2.0)	340 (750) / 380 (838)
	PE45/4, 75/4	17 (38)	3 (7)	11 (24)	0.3 (0.5)	160 (353) / n.a.
	PE56/4	17 (38)	3 (7)	11 (24)	0.3 (0.5)	180 (397) / n.a.
	PE90/4,	17 (38)	3 (7)	11 (24)	0.3 (0.5)	200 (441) / n.a.
150G-CB1	PE105/4	17 (38)	3 (7)	11 (24)	0.3 (0.5)	200 (441) / n.a.
	PE35/6	17 (38)	3 (7)	11 (24)	0.2 (0.4)	170 (375) / n.a.
	PE130/4, 150/4	20 (44)	12 (27)	21 (46)	0.4 (0.9)	340 (750) / 380 (838)
150G-CP	PE185/4, 210/4	20 (44)	12 (27)	21 (46)	0.5 (1.0)	360 (794) / 400 (882)
151E-CB2	PE110/6	20 (44)	12 (27)	21 (46)	0.4 (0.9)	340 (750) / 390 (860)
	PE90/6	20 (44)	n.a.	21 (46)	0.3 (0.5)	340 (750) / 380 (838)
	PE75/4,	20 (44)	3 (7)	11 (24)	0.3 (0.5)	170 (375) / n.a.
	PE90/4	20 (44)	3 (7)	11 (24)	0.3 (0.5)	190 (419) / n.a.
200G-CB1	PE105/4	20 (44)	3 (7)	11 (24)	0.3 (0.5)	200 (441) / n.a.
201G-CB2	PE35/6	20 (44)	3 (7)	11 (24)	0.2 (0.4)	160 (353) / n.a.
	PE90/6, 110/6, 130/6	25 (55)	12 (27)	21 (46)	0.4 (0.9)	380 (838) / 420 (926)
	PE130/6, 120/8	25 (55)	12 (27)	21 (46)	0.4 (0.9)	380 (838) / 420 (926)

table continued



XFP (60 Hz)		Pedestal bracket and fasteners kg (lbs)	Horizontal supports* kg (lbs)	Transportable pump stand kg (lbs)	Cable** kg (lbs)	Pump*** without cable kg (lbs)
105J-CB2	PE160/6	25 (55)	12 (27)	21 (46)	0.3 (0.5)	390 (860) / 440 (970)
	PE200/6	25 (55)	12 (27)	21 (46)	0.5 (1.0)	440 (970) / 480 (1058)
	PE250/4,	19 (42)	17 (38)	50 (110)	0.5 (1.0)	412 (906) / 472 (1038)
	PE350/4,	19 (42)	17 (38)	50 (110)	0.5 (1.0)	442 (972) / 502 (1104)
155J-CB2	PE200/6,	19 (42)	17 (38)	50 (110)	0.5 (1.0)	431 (948) / 491 (1080)
	PE250/6	19 (42)	17 (38)	50 (110)	0.5 (1.0)	445 (979) / 505 (1111)
	PE250/4,	28 (62)	17 (38)	50 (110)	0.5 (1.0)	420 (924) / 470 (1034)
	PE350/4,	28 (62)	17 (38)	50 (110)	0.5 (1.0)	450 (990) / 510 (1122)
206J-CB2	PE200/6,	28 (62)	17 (38)	50 (110)	0.5 (1.0)	445 (979) / 505 (1111)
	PE250/6	28 (62)	17 (38)	50 (110)	0.5 (1.0)	453 (996) / 503 (1106)
255J-CB2	PE200/6	39 (86)	17 (38)	56 (124)	0.5 (1.0)	416 (913) / 546 (1201)
	PE250/6	39 (86)	17 (38)	56 (124)	0.5 (1.0)	494 (1086) / 554 (1218)
305J-CB2	PE200/6	53 (117)	23 (51)	81 (179)	0.5 (1.0)	541 (1190) / 601 (1322)
	PE250/6	53 (117)	23 (51)	81 (179)	0.5 (1.0)	549 (1207) / 609 (1339)
	PE200/6,	74 (163)	43 (95)	91 (201)	0.5 (1.0)	645 (1419) / 705 (1551)
	PE250/6	74 (163)	43 (95)	91 (201)	0.5 (1.0)	653 (1346) / 713 (1568)

* Includes adapter flange for XFP 80C-CB1 and XFP 100C-CB1. ** Weight per ft. *** Without / with cooling jacket.

9.3. Chain (EN 818)*

Length (m / ft)	Weight (kg / lbs)		
	WLL 320	WLL 400	WLL 630
1.6 / 5.24	0.74 / 1.63	-	-
3.0 / 9.84	1.28 / 2.82	1.62 / 3.57	2.72 / 5.99
4.0 / 13.12	1.67 / 3.68	2.06 / 4.54	3.40 / 7.49
6.0 / 19.68	2.45 / 5.40	2.94 / 6.48	4.76 / 10.49
7.0 / 22.96	2.84 / 6.26	3.38 / 7.45	4.92 / 10.84

* For chain supplied by Sulzer only.

	 CAUTION
	Weights of accessories, other than or in addition to those listed, must also be included when specifying the working load of any lifting equipment. Please consult with your local Sulzer representative prior to installation.

10. Lifting, transport and storage

10.1. Lifting

	ATTENTION
	Observe the total weight of the Sulzer units and their attached components! (see nameplate for weight of base unit).

The duplicate nameplate provided must always be located and visible close to where the unit is installed (e.g. at the terminal boxes / control panel where the cables are connected).

	NOTE
	Lifting equipment must be used if the total unit weight and attached accessories exceeds local manual lifting safety regulations.

The total weight of the unit and accessories must be observed when specifying the safe working load of any lifting equipment! The lifting equipment, e.g. crane and chains, must have adequate lifting capacity. The hoist must be adequately dimensioned for the total weight of the Sulzer units (including lifting chains or steel ropes, and all accessories which may be attached). The end user assumes sole responsibility that lifting equipment is certified, in good condition, and inspected regularly by a competent person at intervals in accordance with local regulations. Worn or damaged lifting equipment must not be used and must be properly disposed of. Lifting equipment must also comply with the local safety rules and regulations

	NOTE
	The guidelines for the safe use of chains, ropes and shackles supplied by Sulzer are outlined in the Lifting Equipment manual provided with the items and must be fully adhered to.

Related concepts

[Nameplates](#) on page 9

10.2. Transport

During transport, care should be taken that the pump cannot fall over or roll and cause damage to the pump or injury to the person. The pumps have a lifting hoop for lifting or suspension of the pump.

	 CAUTION
	After removal from its original packaging we recommend that during future transportation of the pump it is laid on its side and securely strapped to a pallet.

10.2.1. Vertical lifting

For vertical lifting attach a chain and shackle to the lifting hoop.

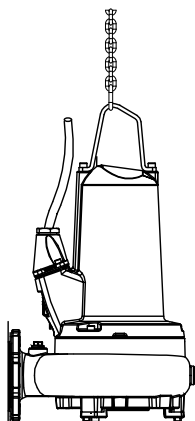

	 DANGER
<p>Dangerous voltage The pump must be raised only by the lifting hoop and never by the power cable.</p>	

10.2.2. Horizontal lifting

XFP pumps can be fitted with eyebolts for horizontal lifting to which a chain and shackle is attached in addition to attaching to the lifting hoop. Screw holes are provided in the volute or bearing housing, depending on the pump model (see location points and sizes below).

Figure 5. XFP 80C - 151E (PE1 & PE2)

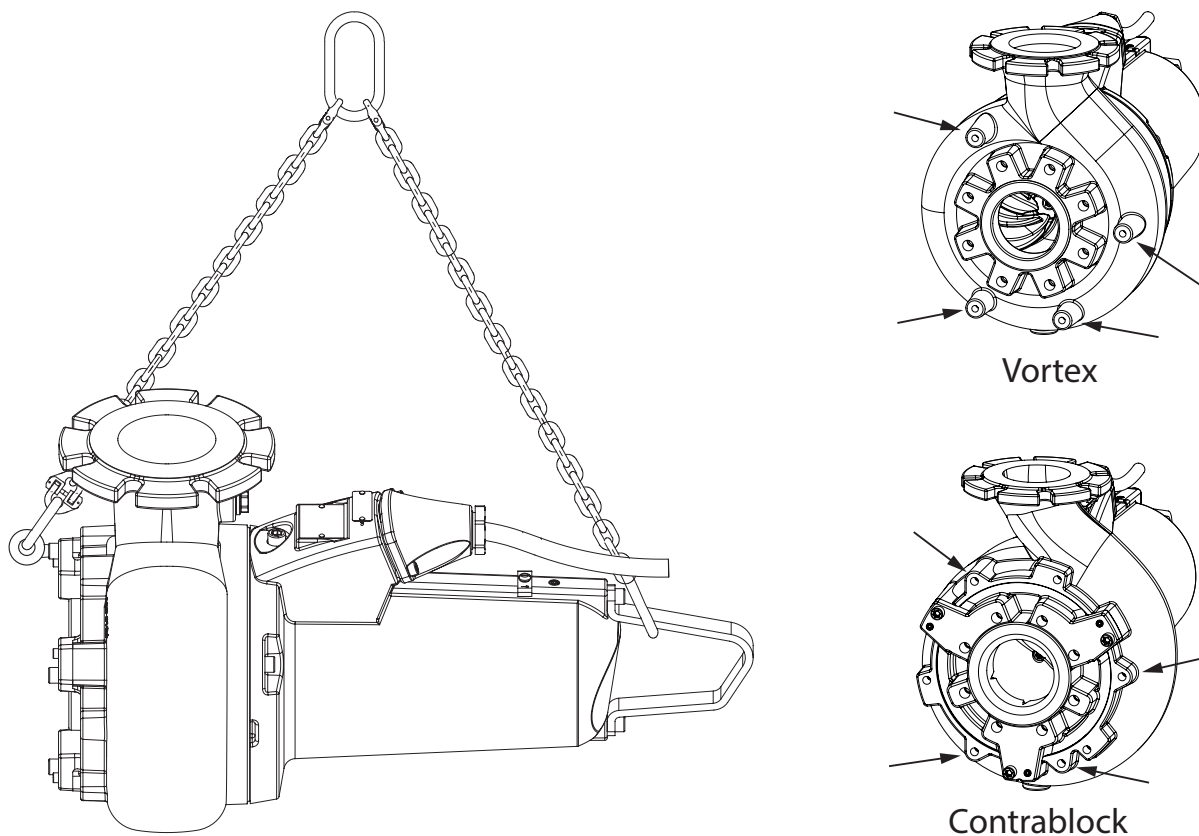

Figure 6. XFP 100G - 305J (PE3)

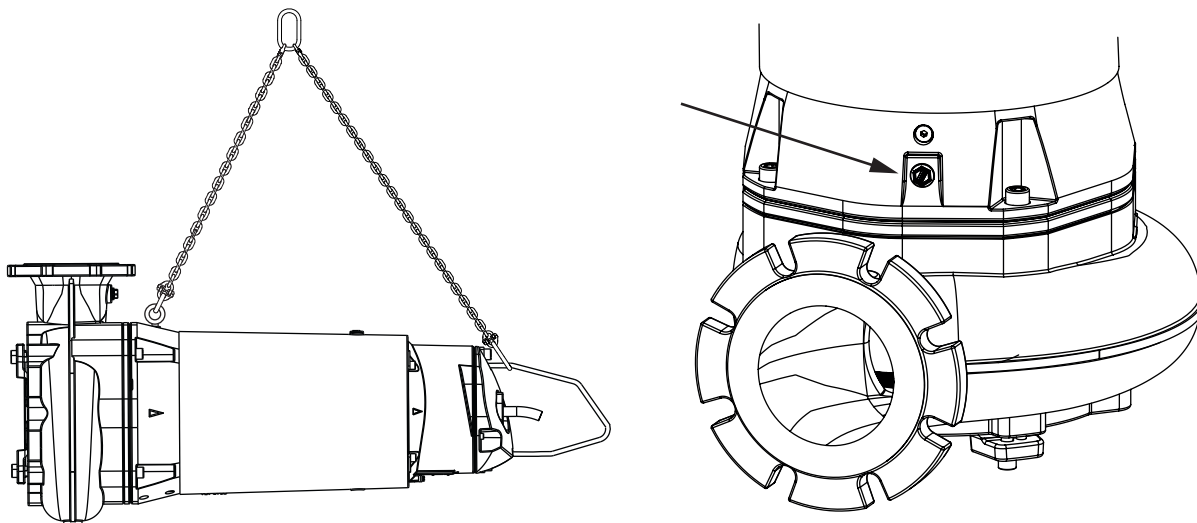
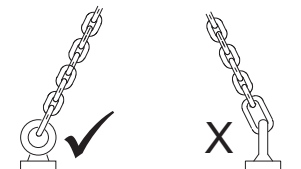

Table 5.

XFP	80C - 100C, 80E, 81E, 100E(VX)	100E(CB) - 151E	100G - 305J
Eyebolt size	M10	M12	M16



	CAUTION
	<p>For angular lifting, shoulder-type machinery eyebolts (EN ISO 3266) rated to take loads $\leq 90^\circ$ must be used and the workload must be adjusted accordingly. The eyebolt must be firmly seated and the load must always be applied in the plane of the eye and not at an angle to it (use a single shim if necessary for correct alignment). Swivel eyebolts (EN 1677-1) can also be used.</p>

10.3. Storage

1. During long periods of storage the pump should be protected from moisture and extremes of cold or heat.
2. To prevent the mechanical seals from sticking it is recommended that occasionally the impeller is rotated by hand.
3. If the pump is being taken out of service the oil should be changed before storage.
4. After storage the pump should be inspected for damage, the oil level should be checked, and the impeller checked to ensure it rotates freely.

10.3.1. Moisture protection of motor connection cable

The motor connection cables are protected against the ingress of moisture along the cable by having the ends sealed at the factory with protective covers.

	ATTENTION
	<p>The ends of the cables should never be immersed in water as the protective covers only provide protection against water spray or similar (IP44) and are not a water tight seal. The covers should only be removed immediately prior to connecting the units electrically.</p>

During storage or installation, prior to the laying and connection of the power cable, particular attention should be given to the prevention of water damage in locations which could flood.

	ATTENTION
	<p>If there is a possibility of water ingress then the cable should be secured so that the end is above the maximum possible flood level. Take care not to damage the cable or its insulation when doing this.</p>



11. Setup and installation

These pumps are designed for wet well vertical installation on a fixed pedestal or as transportable on a pump stand. The pumps are also suitable for horizontal or vertical dry installation (except XFP 80E-CB1-PE125/2-60 Hz, XFP 81E-VX-PE125/2-60 Hz, XFP 81E-VX-PE80/2-60 Hz, and XFP-CP).



The regulations of DIN 1986 as well as local regulations should be observed when installing the pump.

The following guidelines must be observed when setting the lowest switch off point.

- Care must be taken during switching on and operation that the hydraulic section is filled with water (dry installation) or alternatively is submerged or under water (wet installation). Other types of operation e.g. snore operation or dry running are not allowed!
- The minimum submergence allowed for specific pumps can be found on the dimension installation sheets available by download from <https://www.sulzer.com>

	 DANGER
	<p>Dangerous voltage</p> <p>The regulations covering the use of pumps in sewage applications, together with all regulations involving the use of explosion-proof motors, should be observed. The cable ducting to the control panel should be sealed off in a gas-tight manner by the use of a foaming material after the cable and control circuits have been pulled through. In particular the safety regulations covering work in enclosed areas in sewage plants should be observed together with general good technical practice.</p>

11.1. Equipotential bonding

	 DANGER
	<p>Dangerous voltage</p> <p>In pump stations/tanks, equipotential bonding must be carried out according to EN60079-14:2014 [Ex] or IEC 60364-5-54 [non-Ex] (Regulations for the installation of pipelines, protective measures in high voltage systems).</p>

11.1.1. Connection points

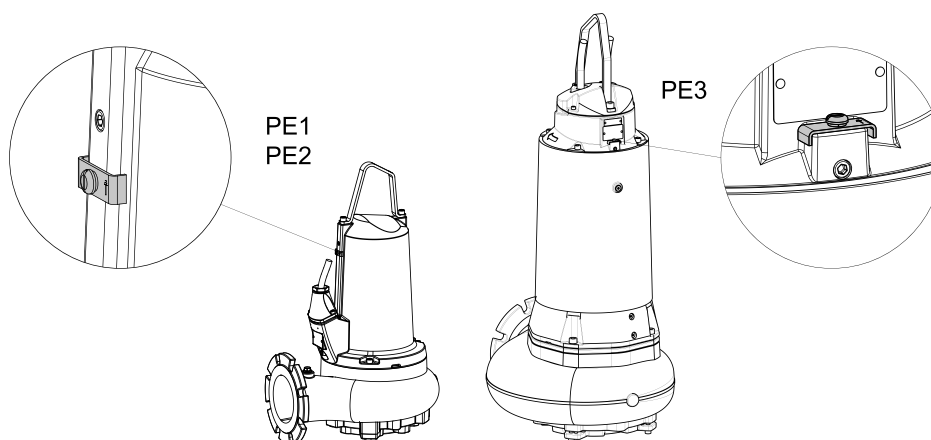

11.2. Discharge line

The discharge line must be installed in compliance with the relevant regulations. DIN 1986/100 and EN 12056 applies in particular to the following:

- The discharge line should be fitted with a backwash loop (180° bend) located above the backwash level and should then flow by gravity into the collection line or sewer.
- The discharge line should not be connected to a down pipe.
- No other inflows or discharge lines should be connected to this discharge line.



ATTENTION

The discharge line should be installed so that it is not affected by frost.

11.3. Installation types

11.3.1. Submerged in a concrete sump

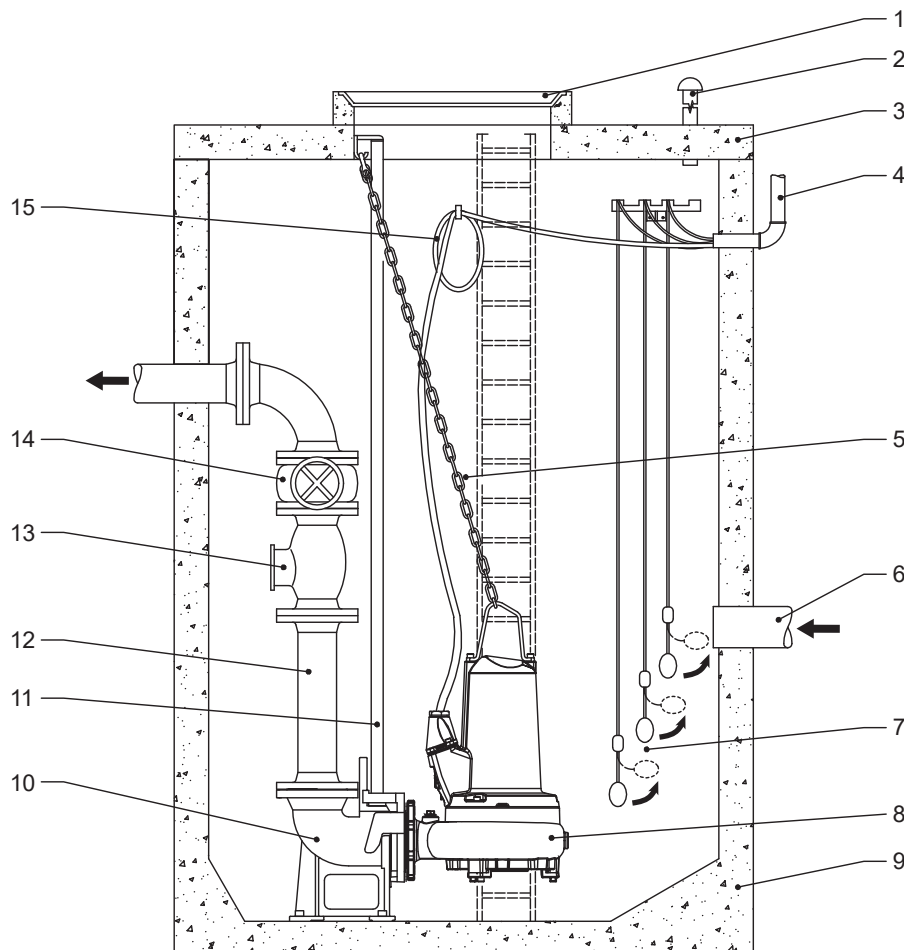

- 1 Sump cover
- 2 Venting line
- 3 Sump cover
- 4 Sleeve for cable ducting to the control panel as well as for aeration and venting
- 5 Chain
- 6 Inflow line
- 7 Ball-type float switch
- 8 Submersible pump
- 9 Concrete sump
- 10 Pedestal
- 11 Guide rail
- 12 Discharge line
- 13 Non-return valve
- 14 Gate valve
- 15 Power cable to motor

Table 6. Fasten the pedestal to the sump base using Sulzer anchor bolt kits:

Pedestal	DN 80 & DN 100	DN 150	DN 200
Part number	62610775	62610784	62610785

Particular attention should be paid to:

- the provision of venting to the sump.
- installation of isolating valves on the discharge line.
- removal of any slack from the power cable by coiling and securing it to the sump wall so that it cannot be damaged during operation of the pump.

!	ATTENTION
<p>The power cable should be handled carefully during installation and removal of the pump in order to avoid damage to the insulation. When raising the pump out of the concrete sump with the hoist ensure that the connection cables are lifted out simultaneously as the pump itself is being raised.</p>	

Related concepts

[Discharge line](#) on page 25

11.3.1.1. Lowering of the pump on the guide rail

About this task

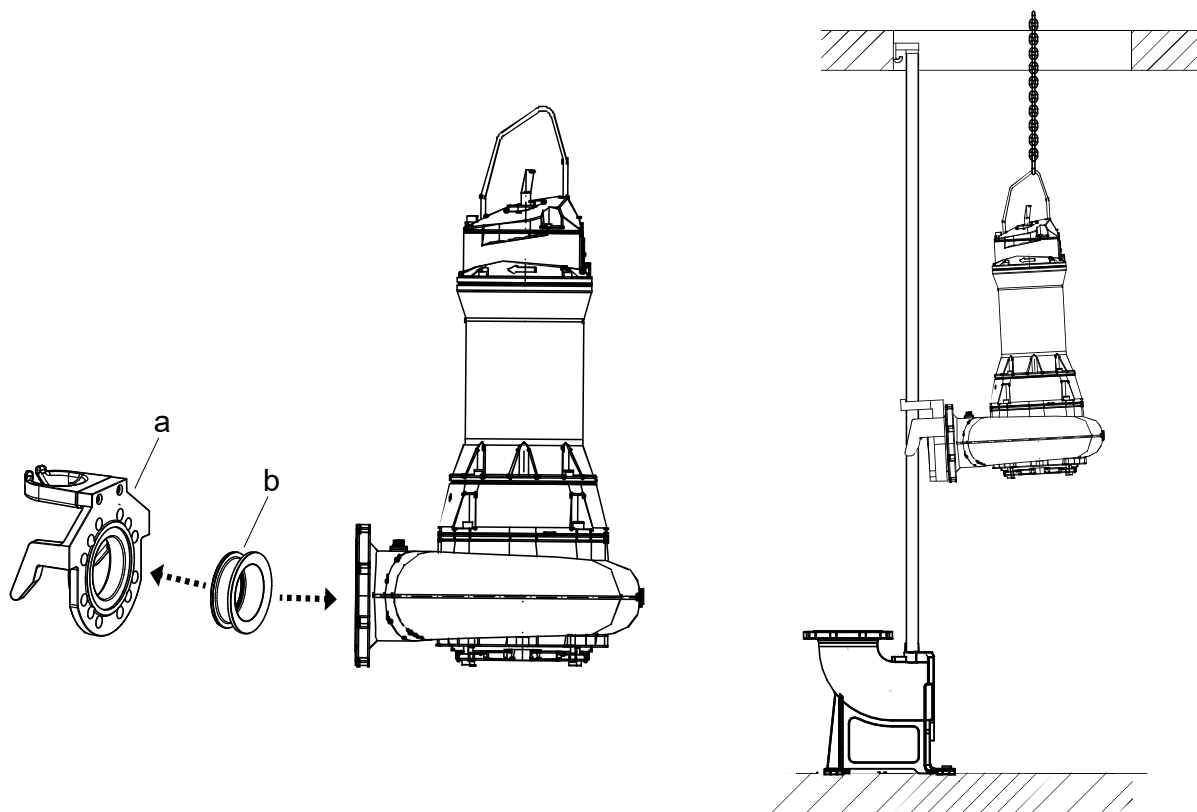

Procedure

1. Fit the pedestal coupling bracket (a) and seal (b) to the discharge flange of the pump.
2. Fit a chain and shackle to the lifting hoop and using a hoist lift the pump into position where the pedestal bracket can slide into place on the guide rail
3. Lower the pump slowly down along the guide rail. Due to the design of the lifting hoop the pump will automatically lower at the necessary angle
4. The pump couples automatically on the pedestal, and seals to a leak-tight connection by the compression from the combination of its own weight and the fitted seal

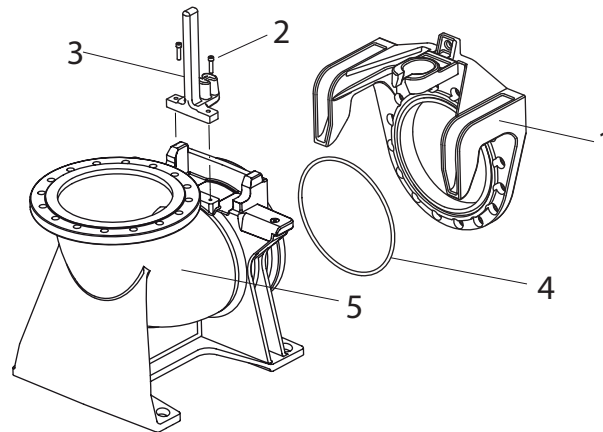
11.3.1.2. Fitting of pedestal bracket o-ring and guide piece**About this task****Legend**

1. Bracket
2. M12 screws
3. Guide piece
4. O-ring
5. Pedestal

Procedure

1. Ensure that the o-ring and the groove in the bracket are clean and free of grease.
2. Screw on the guide piece (3) as shown in the drawing.
3. Attach the guide piece to the pedestal (5) with the two M12 screws (2).
4. Tighten the screws with a torque of 56 Nm.

11.3.2. Dry-installed

Figure 7. Horizontal

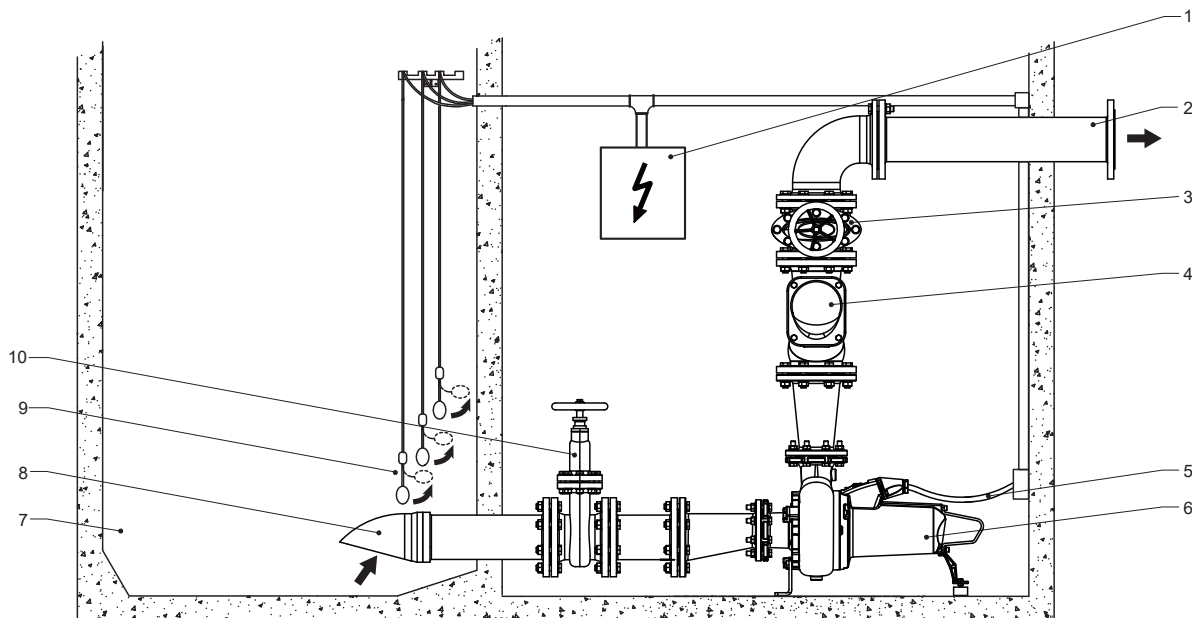

The pump is installed using the Sulzer horizontal support kit as specified for the particular model (assembly leaflet 15975757 is supplied with kit).

Figure 8. Vertical

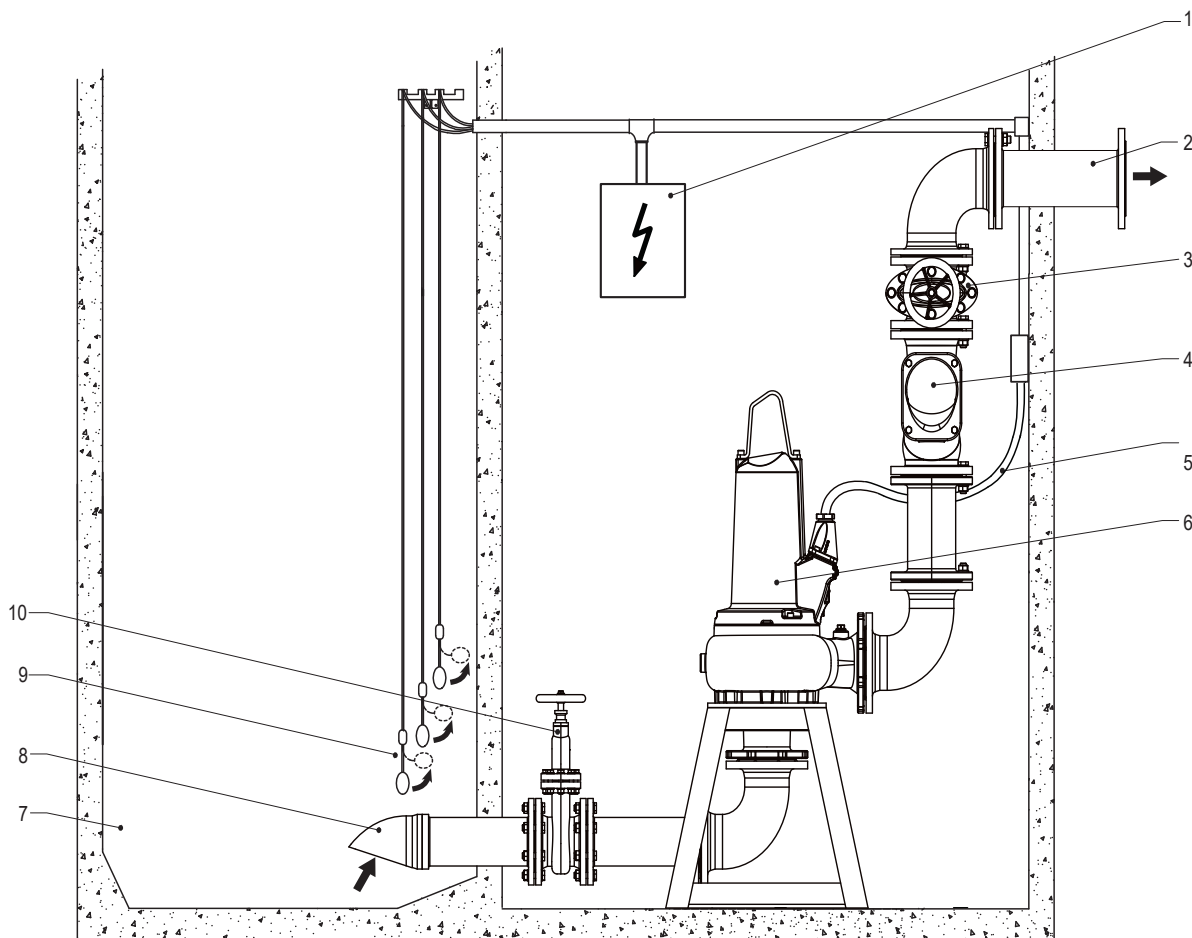

- 1 Control panel
- 2 Discharge line
- 3 Gate valve
- 4 Non-return valve
- 5 Power cable from motor to control panel
- 6 Pump
- 7 Collection sump
- 8 Inflow line
- 9 Ball-type float switch
- 10 Gate valve

Particular attention should be paid to:

- the provision of venting to the sump.
- installation of isolating valves on the inlet and discharge lines.
- removal of any slack from the power cable by coiling and securing it so that it cannot be damaged during operation of the pump.

!	ATTENTION
The power cable should be handled carefully during installation and removal of the pump in order to avoid damage to the insulation.	

	ATTENTION
XFP 100G - 305J pumps must not be dry-installed without a cooling jacket. The oil-cooled version of 80C - 151E must be used.	
	WARNING
<p>Hot surface</p> <p>When dry-installed the pump motor housing may become hot. In such a case, to avoid burn injury, allow to cool down before handling.</p>	

11.3.3. Transportable

About this task

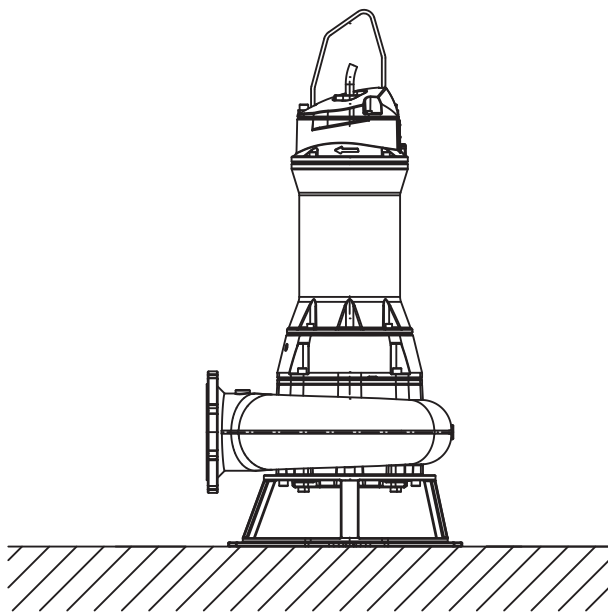

For transportable installation the unit is fitted to a pump stand.

Hoses, pipes and valves must be sized to suit the pump performance.

	DANGER
<p>Dangerous voltage</p> <p>Arrange the cable run so that the cables will not be kinked or nipped.</p>	
	DANGER
<p>Dangerous voltage</p> <p>Submersible pumps used outdoors must be fitted with a power cable of at least 10 meter length. Other regulations may apply in different countries</p>	

Procedure



1. Place the pump on a firm surface which will prevent it from overturning or burrowing down. The pump stand can also be bolted down to the floor surface, or the pump suspended slightly by the lifting handle.
2. Connect the discharge pipe and cable.

11.3.4. Venting of the volute

After lowering the pump into the sump medium, an air lock may occur in the volute causing pumping problems. To clear the air lock, you can shake the pump and/or raise and lower the pump in the medium, until the resulting air bubbles no longer appear at surface level. If necessary, repeat this venting procedure.

We strongly recommend that dry-installed units are vented back into the sump through the drilled and tapped hole in the volute.



12. Electrical connection

	 DANGER
	<p>Dangerous voltage</p> <p>Before commissioning, an expert should check that one of the necessary electrical protective devices is available. Earthing, neutral, earth leakage circuit breakers, etc. must comply with the regulations of the local electricity supply authority and a qualified person should check that these are in perfect order.</p>

	ATTENTION
	<p>The power supply system on site must comply with local regulations with regard to cross-sectional area and maximum voltage drop. The voltage stated on the nameplate of the pump must correspond to that of the mains.</p>

Suitably rated means of disconnection shall be incorporated in the fixed wiring by the installer for all pumps in accordance with applicable local National codes.

The power supply cable must be protected by an adequately dimensioned slow-blow fuse corresponding to the rated power of the unit.



	 DANGER
	<p>Dangerous voltage</p> <p>The incoming power supply as well as the connection of the pump itself to the terminals on the control panel must comply with the circuit diagram of the control panel as well as the motor connection diagrams and must be carried out by a qualified person.</p>

All relevant safety regulations as well as general good technical practice must be complied with.

Submersible pumps used outdoors must be fitted with a power cable of at least 10 meter length. Other regulations may apply in different countries.

In all installations, the power supply to the pump must be via a residual current device (e.g. RCD, ELCB, RCBO etc.) with a rated residual operating current in accordance with local regulations. For installations not having a fixed residual current device the pump must be plugged into the power supply through a portable version of the device.

All three phase pumps must be installed with motor starting and overload protective devices in the fixed wiring by the installer. Such motor control and protective devices must comply with the requirements of IEC standard 60947-4-1. They must be rated for the motor that they control, and wired and set/adjusted according to the instructions provided by the manufacturer. In addition, the overload protective device that is responsive to the motor current shall be set / adjusted to 125% of the marked rated current.

	 DANGER
	<p>Dangerous voltage</p> <p>Risk of electrical shock. Do not remove cord and strain relief and do not connect conduit to pump.</p>

	NOTE
	<p>Please consult your electrician.</p>

The following components should be incorporated in the fixed wiring for all single phase pumps:

- Motor starting and/or running capacitor that complies with the requirements of IEC 60252-1 and rated as specified in the installation instruction. The capacitor shall be class S2 or S3.
- Motor contactor that complies with the requirements of IEC Standard 60947-4-1 and rated for the motor that it controls.

Table 7.

PE1 Capacitor Ratings			
Motor	Start (μF)	Run (μF)	Voltage (V)
PE18/4W	180	50	450
PE20/6W	180	100	450
PE28/4W	180	60	450

12.1. Seal monitoring

XFP pumps are supplied as standard with a leakage sensor (DI), to detect and alert to the ingress of water into the motor and seal chambers (PE1 & PE2), motor (PE3, 50 Hz), or motor and inspection chambers (PE3, 60Hz).

In order to integrate this seal monitoring function into the control panel of the unit it is necessary to fit a Sulzer DI module and connect this in accordance with the circuit diagram below.

Figure 9. Sulzer leakage control type CA 461

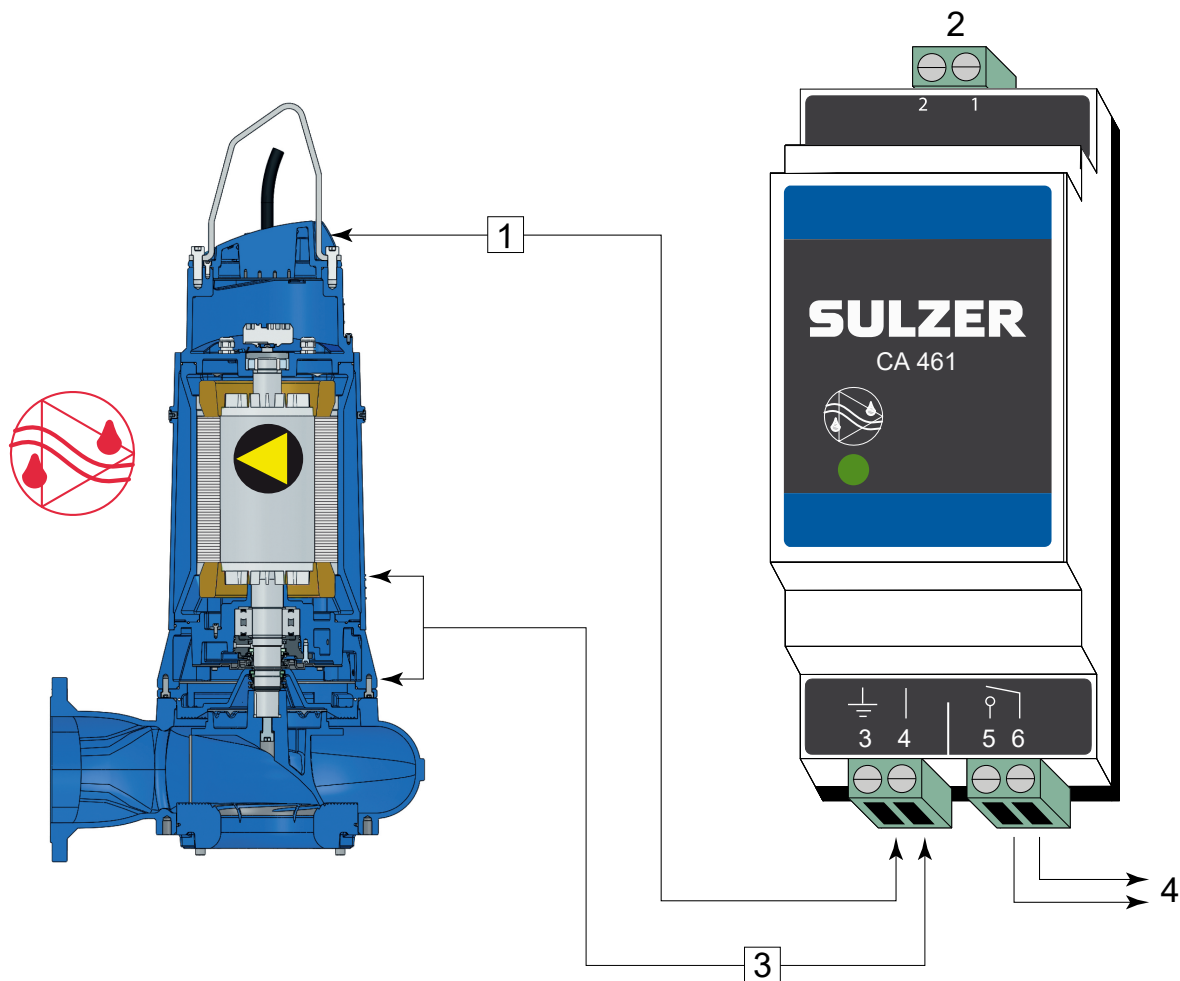

- 1 Connect terminal 3 to ground or housing of the pump.
- 2 Power supply
- 3 Input leakage
- 4 Output

Electronic amplifier for 50/60 Hz

110 - 230 V AC (CSA) - Part No.: 16907010. 18 - 36 VDC, SELV - Part No.: 16907011

Multiple-input leakage control modules are also available. Please consult with your local Sulzer representative.

!	ATTENTION
	Maximum relay contact loading: 2 Ampere

!	ATTENTION
	It is very important to note that with the connection example above it is not possible to identify which sensor/alarm is being activated. As an alternative Sulzer highly recommends to use a separate CA 461 module for each sensor/input, to allow not only identification but also to prompt to the appropriate response to the alarm category/severity.

!	ATTENTION
	If the leakage sensor (DI) is activated the unit must be immediately taken out of service. Please contact your Sulzer service center.

12.2. Temperature monitoring

Thermal sensors in the stator windings protect the motor from overheating.

XFP motors are fitted with three bimetallic thermal sensors in the stator as standard (One per phase), or as an option with three PTC thermistors (One PTC per phase connected in series).

Table 8. PTC Resistance at ambient temperate

	1 x PTC	3 x PTC in series
Resistance	<250Ω	<750Ω
Voltage	2.5Vdc	7.5Vdc

!	NOTE
	PTC relays fitted in control panels and PTC sensors must be in accordance with DIN 44082.

!	NOTE
	Running the pump with the thermal and/or leakage sensors disconnected will invalidate related warranty claims.

12.2.1. Temperature sensor bimetal

Figure 10. Curve showing operation principle of bimetallic temperature limiter

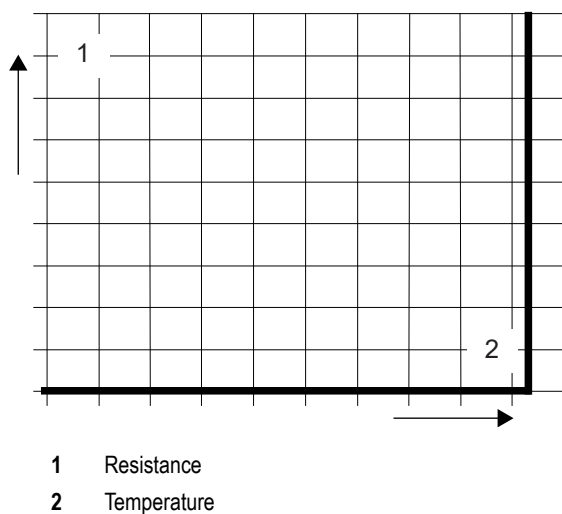



Table 9.

Application	Option
Function	Temperature switch using the bimetallic principle, which opens at a rated temperature
Switching	Taking care not to exceed the allowable switching current, these can be fitted directly into the control circuit

Operating voltage AC	100 V to 500 V ~
Rated voltage AC	250 V
Rated current AC $\cos \varphi = 1,0$	2.5 A
Rated current AC $\cos \varphi = 0,6$	1.6 A
Max. switching current at I_N	5.0 A

ATTENTION	
	<p>The maximum switching ability of the thermal sensors is 5 A, the rated voltage 250 V. Explosion-proof motors which are connected to static frequency inverters must be fitted with thermistors. Activation must be by means of a thermistor protective relay device with PTB approval number.</p>

12.2.2. Temperature sensor PTC

Figure 11. Curve showing principle of operation of thermistor

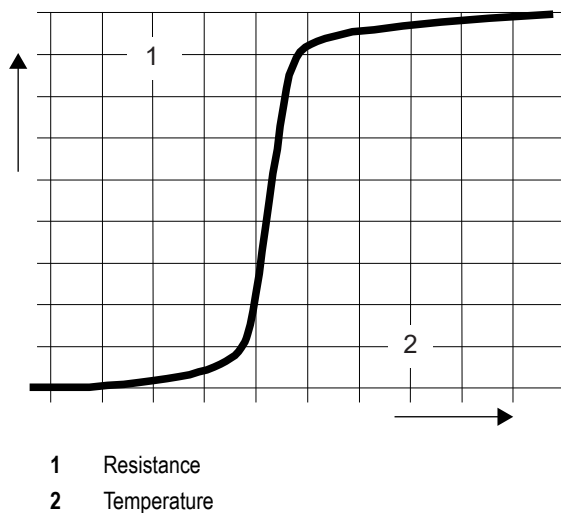

Table 10.

Application	Option
Function	Temperature dependent resistance (no switch) curve with stepwise behavior
Switching	Cannot be installed direct into the control circuit. Evaluation of the signal must be carried out by suit able electronic equipment

!	ATTENTION
<p>Thermistors must never be directly connected into the control or power system. They must always be connected to a suitable evaluation device.</p>	

The thermal monitoring circuit must be wired into the motor contactors in such a manner that a manual reset is required.

12.3. Operation with variable frequency drive (VFD)

The stator design and the insulation grade of the motors from Sulzer means that they are suitable for usage with VFD, according to IEC 60034-25:2022 / NEMA 61800-2:2005. It is however essential that the following conditions are met:

- The guidelines for EMC (electromagnetic compatibility) are complied with.
- Explosion-proof motors must be equipped with thermistors (PTC temperature sensors) if operated in hazardous areas (ATEX Zone 1 and 2).
- Machines designated as Ex machines may never, without exception, be operated using a mains frequency that is greater than the maximum of 50 Hz or 60 Hz as indicated on the nameplate. Make sure that the rated current specified on the nameplate is not exceeded after starting the motors. The maximum number of starts according to the motor data sheet may not be exceeded.
- Machines that are not designated as Ex machines may only be operated using the mains frequency indicated on the nameplate. Greater frequencies can be used but only after consulting with and receiving permission from the Sulzer manufacturing plant.
- For operation of Ex-motors on VFD's, special requirements in relation to the tripping times of the thermo control elements must be observed.
- The lowest frequency must be set so that the minimum fluid velocity of 1 m/s is present in the volute.
- The maximum frequency must be set so that the rated power of the motor is not exceeded.

VFD's must be equipped with adequate filters when used in the critical zone. The filter chosen must be suitable for the VFD with regard to its rated voltage, wave frequency, rated current, and maximum output frequency. Ensure that the voltage characteristics (voltage peaks, dU/dt and rise time of the voltage spikes) at the motor terminal board is in accordance to IEC 60034-25:2022 / NEMA 61800-2:2005. This can be achieved using various types of VFD filters, depending on the specified voltage and cable length. Please contact your supplier for detailed information and the correct configuration.

12.4. Wiring diagrams

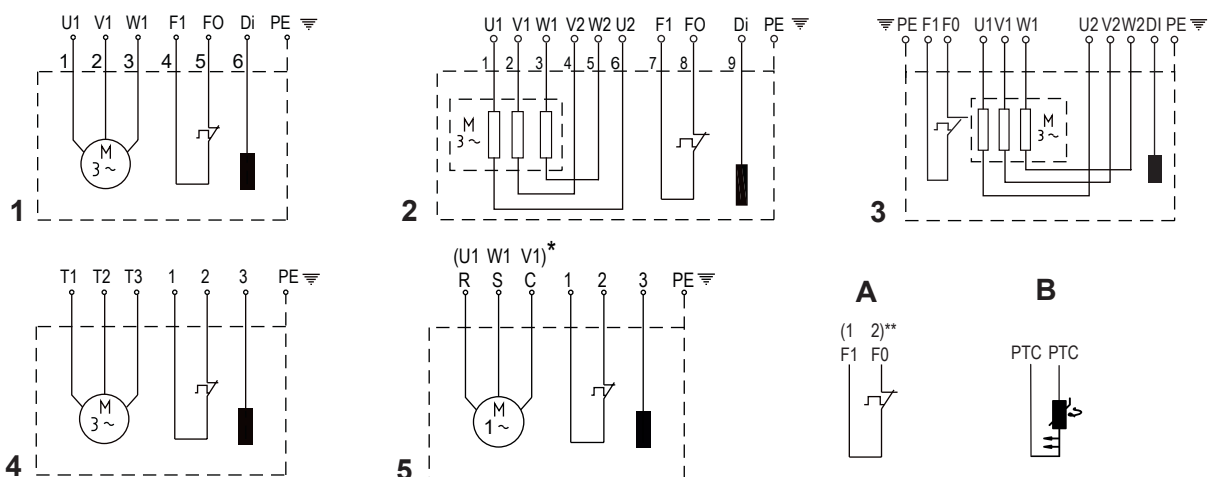

!	NOTE
<p>In all instances "A" can be replaced by "B". Where PTCs are used, leads will be labeled as such at manufacture.</p>	

50 Hz				60 Hz													
	1	2	3	1	2	3	4	5									
13/6	D01,D14, D07	-	-	D68, D80	-	-	D66, D62, D77, D85	-									
15/4																	
22/4																	
29/4																	
30/2																	
40/2	-	D05,D08,		45/2	D80	D64, D67, D81	D66, D62, D77, D85, D86										
30/6	D01,D14, D07	D05		18/4W	-	-	-	W60, W62									
40/4	-	D05,D08, D20	-	-	D64, D67, D81	-	D66, D62, D77, D85, D86	-									
49/4																	
60/4																	
75/4																	
90/4																	
55/2																	
70/2																	
110/2																	
90/6									D05,D08	D20	-	120/8	D64, D67	D81	D66, D62, D77, D85, D86	-	
110/6																	
140/6																	
110/4	D05,D08, D20																
140/4	D05,D08	D20	160/6	D67	D64, D81												
160/4				-	D64, D67, D81												
185/4				D64, D67	D81												
220/4	D08	D05,D20	130/4	-	D64, D81	D66, D62, D77, D85, D86	-										
150/2	D05,D08	D20	150/4														
185/2	D08, D18	D05,D20	185/4					D64, D81									
250/2			D64, D67, D81														
185/6								D64, D81									
300/4	-	D05,D08	210/4					-									D64, D81
220/6			185/2														
			200/2														
			230/2					-	D64, D67, D81								
			300/2						D64, D67, D81								
			250/6		D64, D67, D81												
			350/4	-	D64, D67	D85, D86											
D01 = 400 V 3~, DOL		D05 = 400 V 3~, YΔ		D62 = 230 V 3~, DOL		D68 = 380 V 3~, DOL		D81 = 220 V 3~, YΔ		W60 = 230 V 1~							
D14 = 230 V 3~, DOL		D20 = 230 V 3~, YΔ		D64 = 380 V 3~, YΔ		D77 = 460 V 3~, DOL		D85 = 600 V 3~, DOL		W62 = 208 V 1~							
D07 = 500 V 3~, DOL		D08 = 500 V 3~, YΔ		D66 = 208 V 3~, DOL		D80 = 220 V 3~, DOL		D86 = 460 V 3~, DOL									
D18 = 695 V 3~, DOL				D67 = 460 V 3~, YΔ													

! **DANGER**

Danger of explosion
Explosion-proof pumps may only be used in explosive zones with the thermal sensors connected (leads F0 & F1).

13. Commissioning

! **CAUTION**

All safety hints in other sections must be observed!

! **DANGER**

Danger of explosion
In explosive zones care must be taken that during switching on and operation of the pumps, the pump section is filled with water (dry running) or alternatively is submerged or under water (wet installation). Ensure in this case that the minimum submergence given in the data sheet is observed. Other types of operation e.g. snore operation or dry running are not allowed.

Before commissioning, the pump should be checked and a functional test carried out. Particular attention should be paid to the following:

- Have the electrical connections been carried out in accordance with regulations?
- Have the thermal sensors been connected?
- Is the seal monitoring device correctly installed?

- Is the motor overload switch correctly set?
- Does the unit sit correctly on the pedestal?
- Is the direction of rotation correct - even if run via an emergency generator?
- Are the switching ON and switching OFF levels set correctly?
- Are the level control switches functioning correctly?
- Are the required gate valves (where fitted) open?
- Do the non-return valves (where fitted) function easily?
- Has the volute been vented?
- Have the power and control circuit cables been correctly fitted?
- Was the sump cleaned out?
- Have the inflow and outflows of the pump station been cleaned and checked?
- Have the hydraulics been vented in the case of dry installed units?

13.1. Types of operation and frequency of starting



All pumps of the XFP series have been designed for continuous operation S1 when either submerged or dry-installed.



The maximum allowable starts per hour is 15, at intervals of 4 minutes.

13.2. Direction of rotation

13.2.1. Checking direction of rotation

When three phase units are being commissioned for the first time, and also when used on a new site, the direction of rotation must be carefully checked by a qualified person.

	 CAUTION
	<p>The direction of rotation should only be altered by a qualified person.</p> <p>When checking the direction of rotation, the pump should be secured in such a manner that no danger to personnel is caused by the rotating impeller or by the resulting air flow. Do not place your hand into the hydraulic system!</p>

	 CAUTION
	<p>When checking the direction of rotation, or when starting the unit, pay attention to the START REACTION. This can be very powerful and cause the pump to jerk in the opposite direction to the direction of rotation.</p>

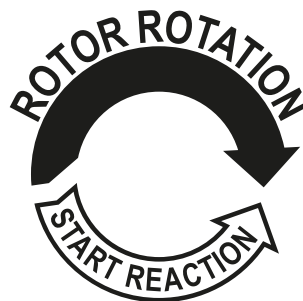



	ATTENTION
	<p>When viewed from above, the direction of rotation is correct if the impeller rotates in a clockwise manner.</p>

	NOTE
	The start reaction is anti-clockwise.



	ATTENTION
	If a number of pumps are connected to a single control panel then each unit must be individually checked.



	ATTENTION
	The mains supply to the control panel should have a clockwise rotation. If the leads are connected in accordance with the circuit diagram and lead designations, the direction of rotation will be correct.

13.2.2. Changing direction of rotation



	 CAUTION
	<p>The direction of rotation should only be altered by a qualified person.</p> <p>If the direction of rotation is incorrect, alter it by changing over two phases of the power supply cable in the control panel. The direction of rotation should then be rechecked.</p>



14. Maintenance and service

	 DANGER
	<p>Dangerous voltage</p> <p>Before commencing any maintenance work the unit should be completely disconnected from the mains by a qualified person and care should be taken that it cannot be inadvertently switched back on.</p>

	 CAUTION
	When carrying out any on-site service or maintenance work i.e. cleaning, venting, fluid inspection or changing, and adjustment of the bottom plate gap, the safety regulations covering work in enclosed areas of sewage installations as well as good general technical practices should be followed.

	 CAUTION
	Repair work must only be carried out by qualified personnel approved by Sulzer.

	 WARNING
	<p>Hot surface</p> <p>Under continuous running conditions the pump motor housing can become very hot. To prevent burn injury allow to cool down before handling.</p>

	WARNING
	<p>Hot liquid</p> <p>Coolant temperature can reach up to 60 °C under normal operating conditions.</p>
	ATTENTION
	<p>The maintenance instructions given here are not designed for “do-it-yourself” repairs as special technical knowledge is required.</p>

14.1. General maintenance instructions

Sulzer units are reliable quality products, each being subjected to careful final inspection. Lubricated-for-life ball bearings, together with monitoring devices, ensure optimum reliability provided that the unit has been connected and operated in accordance with the operating instructions.

Should, nevertheless, a malfunction occur, do not improvise but ask your Sulzer customer service department for assistance.

This applies particularly if the unit is continually switched off by the current overload in the control panel, by the thermal sensors/ limiters of the thermo-control system, or by the seal monitoring system (DI).

Regular inspection and care is recommended to ensure a long service life. Service intervals vary for Sulzer units depending on installation and application. Contact your local Sulzer Service Center for more information. A maintenance contract with our Service Department will guarantee the best technical service.

The Sulzer service organisation would be pleased to advise you on any applications you may have and to assist you in solving any problems you may encounter.

When carrying out repairs, only original spare parts supplied by the manufacturer should be used. Sulzer warranty conditions are only valid provided repair work has been carried out in a Sulzer approved workshop, and original Sulzer spare parts have been used.

	ATTENTION
	<p>Repair work on explosion-proof motors may only be carried out in authorized workshops by qualified personnel using original parts supplied by the manufacturer. Otherwise the Ex-approvals are no longer valid. Detailed technical information is available in the technical data sheet which can be downloaded from https://www.sulzer.com</p>

14.1.1. Inspection intervals

Inspection chamber: The oil in the inspection chamber should be checked every 12 months. Change the oil immediately if it is contaminated by water, or if an alarm indicates seal failure. If it happens again shortly after the oil has been changed, please contact your local Sulzer Service Representative.

Motor chamber: The motor chamber should be inspected every 12 months to ensure it is free from moisture.

14.2. Lubricant changing (PE1 & PE2)

The seal chamber between the motor and the hydraulic section has been filled with oil at manufacture.

An oil change is only necessary:

- at specified service intervals (for details contact your local Sulzer Service Center).
- if the DI leakage sensor detects an ingress of water into the seal chamber or motor chamber.
- after repair work that requires draining of the oil.
- if the pump is being taken out of service the oil should be changed before storage.

14.2.1. Drain and fill the seal chamber (PE1 & PE2)

About this task

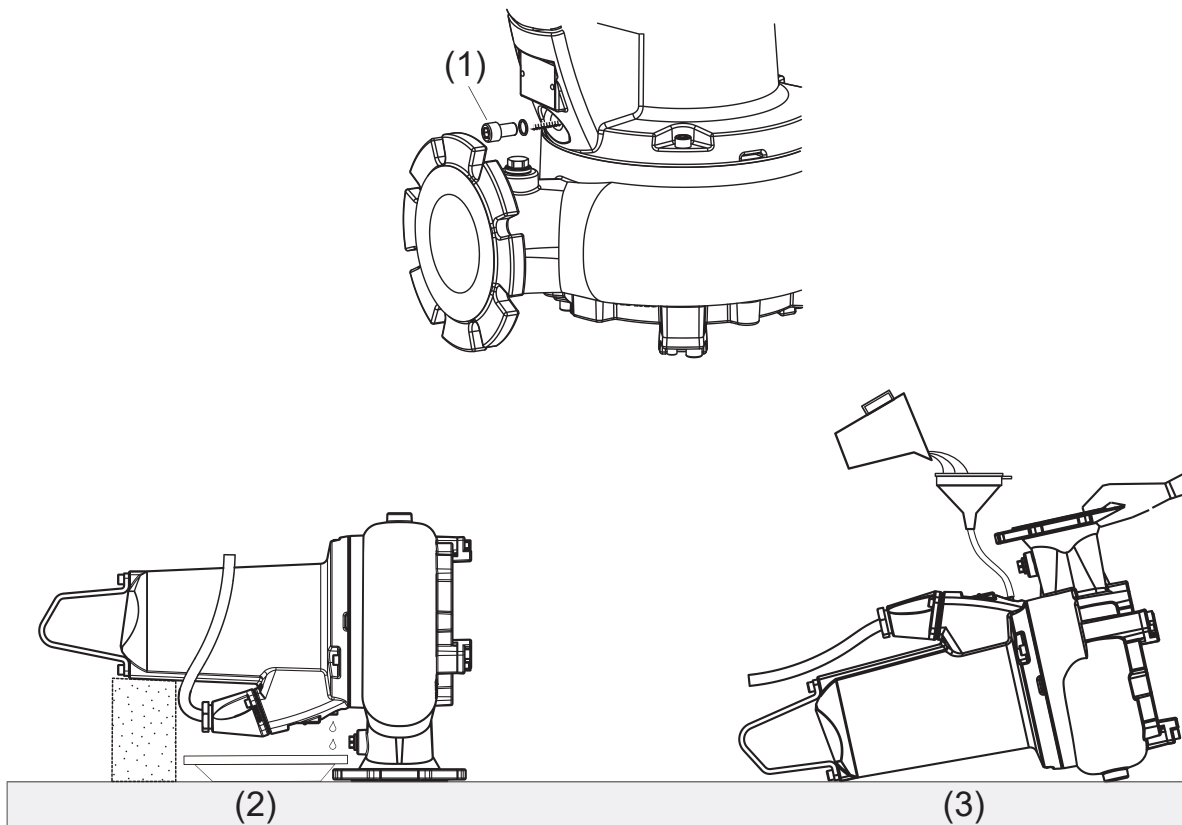

- 1 Drain plug screw
- 2 Drain
- 3 Fill

Procedure



1. Loosen the drain plug screw (1) enough to release any pressure that may have built-up, and re-tighten

!	NOTE
	Before doing so, place a cloth over the plug screw to contain any possible spray of oil as the pump de-pressurizes

2. Place the pump in a horizontal position, sitting on its discharge flange, with the motor housing supported from underneath.

!	CAUTION
	To prevent the pump from toppling over ensure it is supported to lie flat on its discharge flange.

3. Position an adequate container to receive the waste oil.
4. Remove the plug screw and seal ring (1) from the drain hole.
5. After the oil is fully drained lay the pump flat, and rotate so that the drain hole is positioned to the top.

	 CAUTION
	When in this position the pump must be held by hand, or supported at both sides, to prevent it from toppling over.

6. Select the required volume of oil from the quantities table and slowly pour into the drain hole.
7. Refit the plug screw and seal ring.

Related references

[Oil and glycol quantities \(liters\)](#) on page 46

14.3. Lubricant changing (PE3 - version without cooling jacket)

An oil change is only necessary:

- at specified service intervals (for details contact your local Sulzer Service Center).
- if the DI leakage sensor detects an ingress of water into the motor, seal, or inspection chambers.
- after repair work that requires draining of the oil.
- if the pump is being taken out of service the oil should be changed before storage.

14.3.1. Drain and fill the inspection and seal chambers (PE3 - version without cooling jacket)

About this task

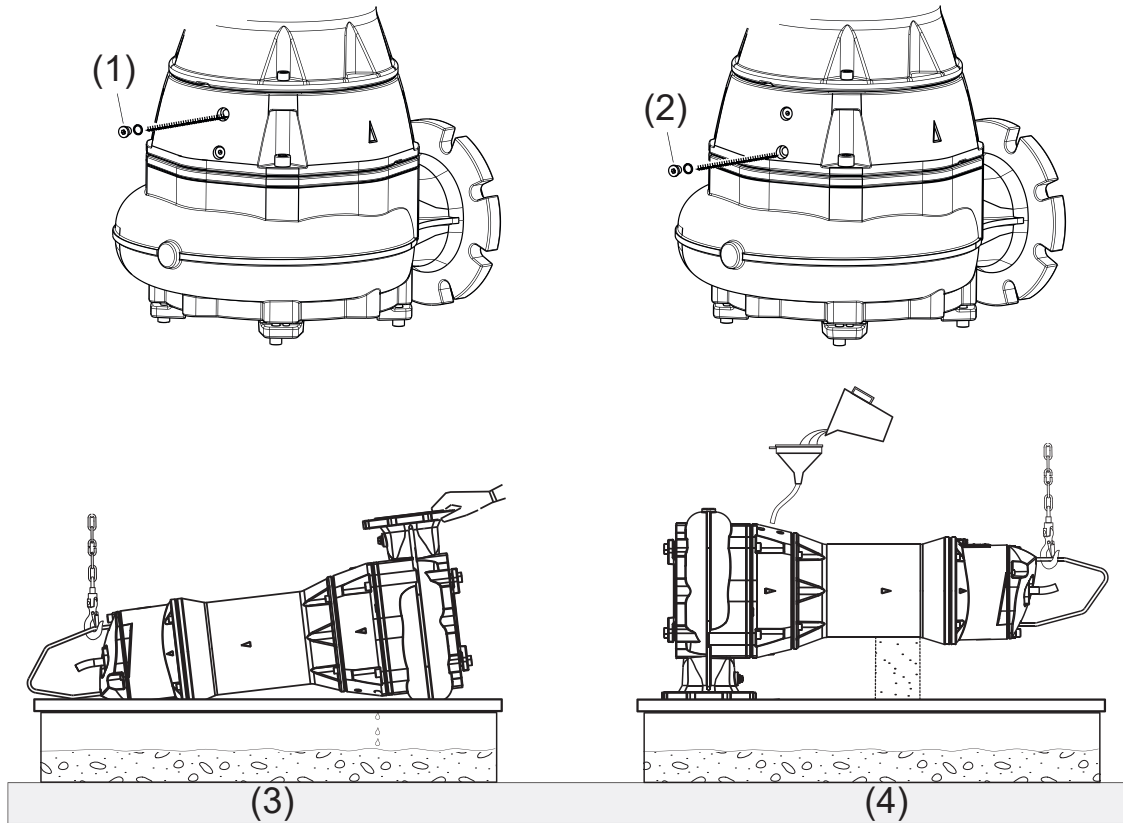

- 1 Seal ring - Inspection chamber
- 2 Seal ring - Seal chamber
- 3 Drain
- 4 Fill

Procedure

1. Loosen the drain plug screw (1 / 2) enough to release any pressure that may have built-up, and re-tighten.

	CAUTION
	Before doing so, place a cloth over the plug screw to contain any possible spray of oil as the pump de-pressurizes

2. Secure a hoist to the lifting hoop. Lay the pump on its side and rotate until the drain plug is underneath.

Note: because there is insufficient space to place a waste container underneath the drain plug the waste must be drained into a sump.

3. Remove the plug screw and seal ring (1 / 2) from the drain hole.
4. After the oil is fully drained, place the pump in a horizontal position sitting on its discharge flange with the motor housing supported from underneath.

	CAUTION
	To prevent the pump from toppling over ensure it is supported to lie flat on its discharge flange.

5. Select the required volume of oil from the quantities table and slowly pour into the drain hole.
6. Refit the plug screw and seal ring.

Related references

[Oil and glycol quantities \(liters\)](#) on page 46

14.4. Coolant changing (PE3 - version with cooling jacket)

The cooling system (seal chamber and cooling jacket) has been filled with glycol at manufacture. The water and propylene glycol is frost resisting down to -15 °C / 5 °F.

A glycol change is only necessary:

- at specified service intervals (for details contact your local Sulzer Service Center).
- if the DI leakage sensor detects an ingress of water into the motor chamber or seal chamber.
- after repair work that requires draining of the glycol.
- if the pump is being taken out of service the glycol should be changed before storage.
- in the case of extreme ambient temperatures below -15 °C / 5 °F (e.g. during transport, storage, or if the pump is out of duty) the cooling liquid must be drained. Otherwise the pump may be damaged.

14.4.1. Drain and fill the cooling system (PE3 - version with cooling jacket)

About this task

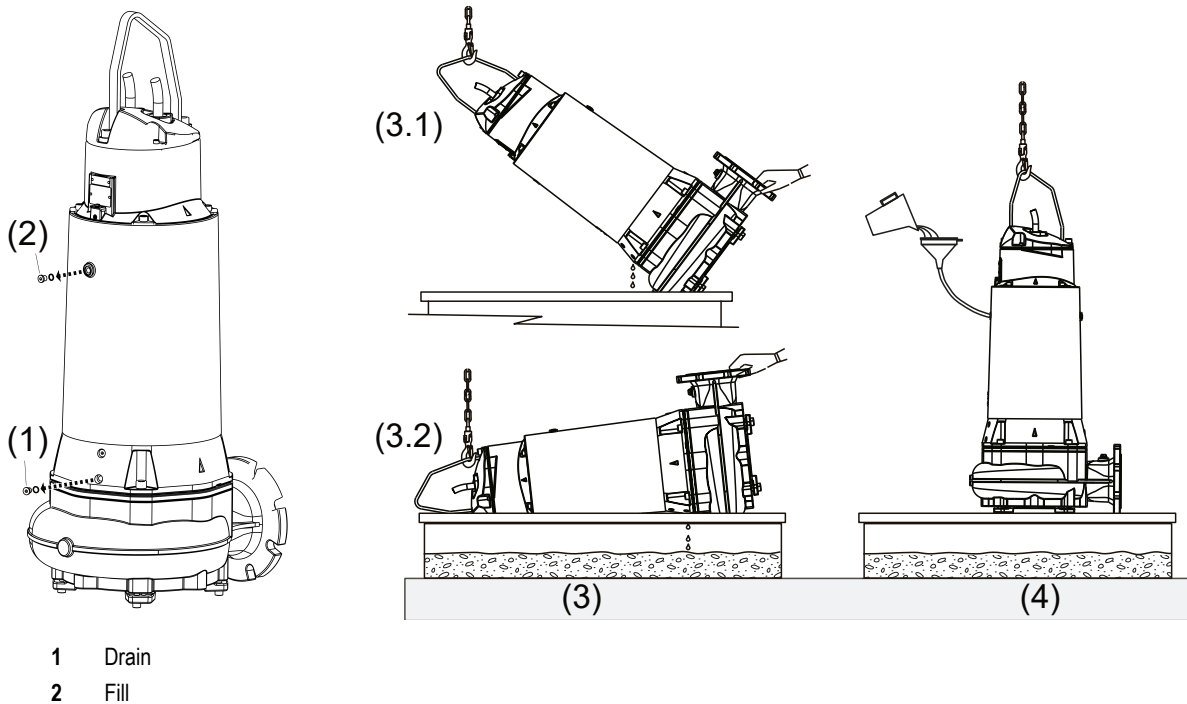

Procedure

1. Loosen the plug screw (1) or (2), enough to release any pressure that may have built-up, and re-tighten.

!	NOTE
	Before doing so, place a cloth over the plug screw to contain any possible spray of glycol as the pump de-pressurizes.

2. Secure a hoist to the lifting hoop. Tilt the pump to 45° with the drain plug underneath.

Note: because there is insufficient space to place a waste container underneath the drain plug by the completion of step 5, the waste must be drained into a sump.

3. Remove the plug screw and seal ring (1) from the drain hole.
4. Glycol will drain from the cooling jacket chamber.
5. When the flow stops, continue to gradually tilt the pump until horizontal. This will drain the remaining glycol from the seal chamber.

Note: draining the glycol entirely with the pump in a horizontal position would result in some glycol being retained in the cooling jacket.

6. After the glycol is fully drained raise the pump into its upright position and refit the plug screw and seal ring (1).
7. Remove the plug screw and seal ring (2) from the fill hole.
8. Select the required volume of glycol from the quantities table and slowly pour into the fill hole.
9. Refit the plug screw and seal ring (2).

14.5. Oil and glycol quantities (liters)

Table 11.

XFP	Motor		Without cooling jacket	With cooling jacket
	50 Hz	60 Hz	Lubricant - oil	Coolant - water and propylene glycol
PE1	PE30/2 PE40/2 PE15/4 PE22/4 PE29/4 PE13/6	PE45/2 PE22/4 PE28/4 PE35/4 PE18/4W PE28/4W PE20/6 PE20/6W	0.43	-
PE2	PE70/2 PE110/2 PE40/4 PE49/4 PE55/2 PE60/4 PE70/2 PE75/4 PE90/4 PE30/6	PE80/2 PE125/2 PE100/2 PE45/4 PE56/4 PE75/4 PE90/4 PE105/4 PE35/6	0.68	-

table continued

XFP	Motor		Without cooling jacket		With cooling jacket		
	50 Hz	60 Hz	Lubricant - oil		Coolant - water and propylene glycol		
PE3	PE150/2 PE185/2 PE250/2 PE110/4 PE140/4 PE160/4 PE185/4 PE90/6 PE110/6 PE140/6	PE185/2 PE200/2 PE230/2 PE300/2 PE130/4 PE150/4 PE185/4 PE210/4 PE90/6 PE110/6 PE130/6 PE160/6 PE120/8	Seal chamber 8.0	Inspection chamber 0.40	Inspection chamber (Oil) 0.40	16.5	
	PE220/4 PE300/4 PE185/6 PE220/6	PE250/4 PE350/4 PE200/6	XFP-G: 8.0	XFP-J: 4.0	0.42	0.42	18.0
		PE250/6	4.0				

Volume ratio: 86% oil or water/propylene glycol: 14% air

Specification: Lubricant PE1 & PE2: white mineral oil VG8 - VG10. Lubricant PE3: hydraulic oil VG32 HLP-D. Coolant PE3: 70% water/30% glycol

14.6. Bottom plate adjustment (CB & CP)

At manufacture, the bottom plate is fitted to the volute with the correct clearance gap set between the impeller and the bottom plate (for optimum performance max 0.2 mm).

14.6.1. Adjust the bottom plate (CB & CP)

About this task

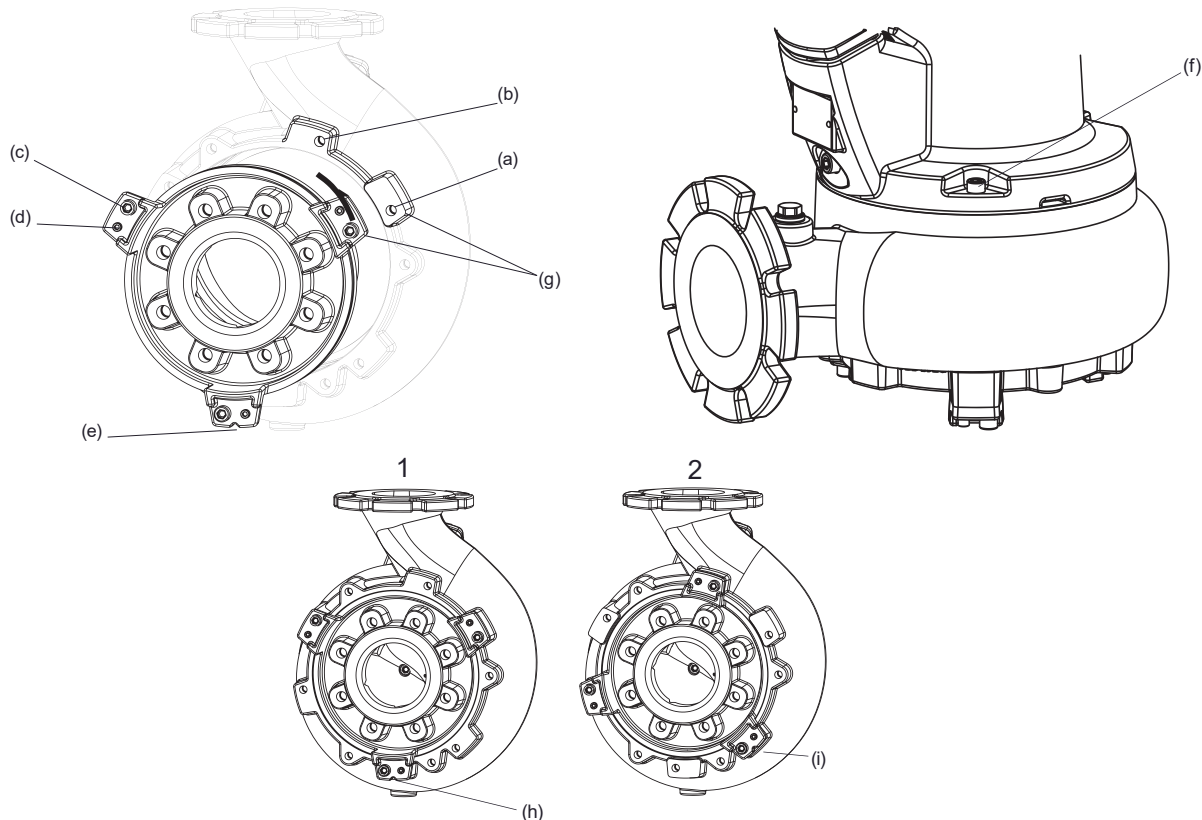

- 1 Factory pre-set position
2 Adjustment position

Note: when adjusting PE3 and CP pumps, steps 1, 2 and 3 do not apply.

To reset the clearance gap following wear: Remove the three screws (c) securing the bottom plate to the volute.

Procedure

1. Check the position of the alignment notch (e) in the fixing lug (g) to determine if the bottom plate is in the factory pre-set position (h) or if the clearance gap has been previously adjusted (i). If previously adjusted proceed to Step 4.
2. Remove the three screws (c) securing the bottom plate to the volute.



ATTENTION

If, due to corrosion, the bottom plate does not release freely from the volute, DO NOT force it free by tightening the adjusting grub screws (d) against the fixing lugs (g) on the volute as this could damage the lugs on the bottom plate beyond repair! In that case, first remove the volute from the motor housing by releasing the three securing screws (f) and then remove the bottom plate by tapping it free from inside the volute using a mallet and block of wood.

3. Rotate the bottom plate anti-clockwise through 45° from the pre-set position (a) to the secondary alignment position (b) and refit the securing screws.
4. Loosen the adjusting grub screws (d) and tighten the securing screws in the bottom plate evenly until the impeller will lightly, but freely, rub against the bottom plate when rotated by hand
5. Tighten the grub screws fully to secure the bottom plate in position (max. 33 Nm)

14.7. Bearings and mechanical seals

These units are fitted with lubricated-for-life ball bearings. The XFP PE3 upper bearing is a grease-lubricated cylindrical roller bearing. Shaft sealing is by means of double mechanical seals. XFP PE3 has an additional inner lipseal at the motor side.

	ATTENTION
	Once removed, bearings and seals must not be re-used, and must be replaced in an approved workshop with genuine Sulzer spare parts.

14.8. Changing the power cable



	 DANGER
	<p>Dangerous voltage</p> <p>The power cable must be replaced by the manufacturer, its service agent or a similar qualified person, in strict adherence to relevant safety regulations.</p>

PE1 & PE2: To facilitate quick and easy changing or repair of the power cable, the connection between the cable and motor is by means of an integrated 10-pole terminal block.

14.9. Clearing pump blockage

14.9.1. Instructions for operator

The operator should only attempt to unblock the pump by re-setting the overload reset button or MCB on the control panel. The initial start force may be enough to displace any clogged material. If the pump continues to trip out on restart then a qualified service agent must be called.

	 DANGER
	<p>Dangerous voltage</p> <p>To carry out the procedure above safely the control panel must not need to be opened to do so. The overload reset button or MCB must therefore be an externally mounted design.</p>

Related concepts

[Personal protective equipment](#) on page 8



[Lifting](#) on page 21



[Bottom plate adjustment \(CB & CP\)](#) on page 47

14.9.2. Instructions for service personnel

About this task

	 DANGER
	<p>Dangerous voltage</p> <p>The pump must be isolated from the power supply before removing it from the installation</p>

	 CAUTION
	Adequate personal protective equipment must be worn at all times.

	 CAUTION
	Lifting safety regulations must be adhered to when lifting the pump.

Procedure

1. Ensure that the pump is secured so that it cannot topple or roll over.
2. Use pump pliers to check for rags etc in the volute inlet and discharge, and try to turn the impeller by hand to check if there is anything jammed behind it.

	ATTENTION
	Never use fingers, even in gloves, to check around the volute internally due to the danger of something sharp piercing the gloves and skin.

3. Remove the bottom plate and clear out any debris with a pliers.
4. If the impeller is still jammed from behind then the impeller has to be removed.
5. The impeller and bottom plate should be checked for impact and wear damage.
6. Once the debris has been cleared out the impeller is refitted and should rotate freely by hand.
7. Refit the bottom plate

	ATTENTION
	The gap between the bottom plate must be checked and adjusted if necessary. This is important as a measure to help prevent future blockages.

8. Reconnect the pump to the power source and dry run to check audibly for bearing or other mechanical damage.

	ATTENTION
	Secure the pump so it cannot roll or fall on starting, and do not stand near the pump or directly in front of the pump discharge.



14.10. Cleaning

If the pump is used for transportable applications, then in order to avoid deposits of dirt and encrustation it should be cleaned after each usage by pumping clear water. In the case of fixed installation, we recommend that the functioning of the automatic level control system be checked regularly. By switching the selection switch (switch setting "HAND") the sump will be emptied. If deposits of dirt are visible on the floats then these should be cleaned. After cleaning, the pump should be rinsed out with clear water and a number of automatic pumping cycles carried out.

15. Troubleshooting guide

Table 12.

Fault	Cause	Fix
Pump does not run	Leakage sensor shutdown	Check for loose or damaged oil plug, or locate and replace faulty mechanical seal / damaged o-rings. Change oil. ¹⁾
	Air lock in volute	Shake or raise and lower the pump repeatedly until resulting air bubbles no longer appear at surface level.
	Level control override	Check for float switch that is faulty or tangled and held in OFF position in sump.
	Impeller jammed.	Inspect and remove jammed object. Check gap between impeller and bottom plate and adjust if necessary.
	Gate valve closed, non-return valve blocked.	Open gate valve, clean blockage from non-return valve.
Pump switching on/off intermittently	Temperature sensor shutdown.	Motor will restart automatically when pump cools down. Check thermal relay settings in control panel. Check for impeller blockage. If none of above, a service inspection is required. ¹⁾
Low head or flow	Wrong direction of rotation.	Change rotation by interchanging two phases of the power supply cable.
	Gap too wide between impeller and bottom plate	Reduce gap.
	Gate valve partially open.	Open valve fully.
Excessive noise or vibration	Defective bearing.	Replace bearing. ¹⁾
	Clogged impeller.	Clear the pump blockage to remove and clean hydraulics.
	Wrong direction of rotation.	Change rotation by interchanging two phases of the power supply cable.
¹⁾ Pump must be taken to approved workshop.		

	<p style="text-align: center;"> CAUTION</p> <p>Before commencing any inspection or repair work the pump should be completely disconnected from the mains by a qualified person and care should be taken that it cannot be inadvertently switched back on.</p>
---	---

Related concepts

[Bottom plate adjustment \(CB & CP\)](#) on page 47

[Instructions for operator](#) on page 49

Related tasks

[Instructions for service personnel](#) on page 49

16. Company details

Address: Sulzer Pump Solutions Ireland Ltd., Clonard Road, Wexford, Ireland

Telephone: +353 53 91 63 200

Website: www.sulzer.com