



SULZER

30005 Channel Series



EN

Installation and Operating Instructions

www.sulzer.com

**SULZER**

EN: Declaration of Conformity	DA: Overensstemmelseserklæring	TR: Uygunluk beyanına
DE: Konformitätserklärung	FI: Vaatimustenmukaisuusvakuutus	BG: Декларация за съответствие
FR: Déclaration de Conformité	PL: Deklaracja zgodności	RO: Declarație de conformitate
ES: Declaración de Conformidad	HU: Megfelelőségi nyilatkozat	SR: Izjava o usaglašenosti
PT: Declaração de conformidade	EL: Δήλωση επαρμοίνησης	LV: Atbilstības deklarācija
IT: Dichiarazione di conformità	ET: Vastavusdeklaratsioon	LT: Atitikties deklaracija
NL: Overeenkomstigheidsverklaring	CS: Prohlášení o shod	RU: Заявление о соответствии
SV: Försäkran om överensstämmelse	SL: Izjava o skladnosti	HR: Izjava o suglasnosti
NO: Samsvarserklæring	SK: Vyhlásenie o zhode	

EN: Manufacturer / Address:	DA: Producent / Adresse:	TR: Üretici / Adres:
DE: Hersteller / Adresse:	FI: Valmistaja / Osoite:	BG: Производител / Адрес:
FR: Fabricant / Adresses:	PL: Producent / Adres:	RO: Producător / Adresa:
ES: Fabricante / Dirección:	HU: Gyártó/vCím:	SR: Proizvođač / Adresa:
PT: Fabricante / Endereço:	EL: Κατασκευαστής / Διεύθυνση:	LV: Ražotājs / Adrese:
IT: Costruttore / Indirizzo:	ET: Tootja / Aadress:	LT: Gamintojas / Adresas:
NL: Fabrikant / Adres:	CS: Výrobce / Adresa:	RU: Изготовитель / Адрес:
SV: Tillverkare / Adress:	SL: Proizvajalec / Naslov:	HR: Proizvođač/Adresa:
NO: Produsent / Adresse:	SK: Výrobca / Adresa:	

JWC Environmental, Unit 15, Daneside Business Park, River Dane Road, Congleton, Cheshire CW12 1UN, United Kingdom

EN: Name and address of the person authorised to compile the technical file to the authorities on request:
DE: Name und Adresse der Person, die berechtigt ist, das technische Datenblatt den Behörden auf Anfrage zusammenzustellen:
FR: Nom et adresse de la personne autorisée pour générer le fichier technique auprès des autorités sur demande:
ES: Nombre y dirección de la persona autorizada para compilar a pedido el archivo técnico destinado a las autoridades:
PT: Nome e endereço da pessoa autorizada a compilar o ficheir técnico para as autoridades, caso solicitado:
IT: Il nome e l'indirizzo della persona autorizzata a compilare la documentazione tecnica per le autorità dietro richiesta:
NL: Naam en adres van de persoon die geautoriseerd is voor het op verzoek samenstellen van het technisch bestand:
SV: Namn och adress på den person som är auktoriserad att på begäran utarbeta den tekniska dokumentsamlingen till myndigheterna:
NO: Navn og adresse på den personen som har tillatelse til å sette sammen den tekniske file til myndighetene ved forespørsel:
DA: Navn og adresse på den person, der har tilladelse til at samle den tekniske dokumentation til myndighederne ved anmodning om dette:
FI: Viranomaisten vaatiessa teknisten tietojen lomaketta lomakkeen valtuutetun laatijan nimi ja osoite:
PL: Nazwisko i adres osoby upoważnionej do przygotowania dokumentacji technicznej w przypadku, gdy jest ona wymagana przez władze:
HU: A hatóságok kérésére a műszaki adatokat tartalmazó akta összeállítására meghatalmazott személy neve és címe:
EL: Όνομα και διεύθυνση του ατόμου που είναι εξουσιοδοτημένο για τη σύνταξη του τεχνικού φακέλου προς τις αρχές επί τη αιτήσεως:
ET: Isiku nimi ja aadress, kelle pädevuses on koostada nõudmise korral ametiasutustele tehnilist dokumentatsiooni:
CS: Jméno a adresa osoby oprávněné vytvořit, na vyžádání ze strany úřadů, soubor technické dokumentace:
SL: Ime in naslov osebe, pooblaščenega za zbiranje tehničnih podatkov za pooblaščenega organe na zahtevo:
SK: Meno a adresa osoby oprávnenej na zostavenie technického súboru pre úrady na požiadanie:
TR: Yetkili makamlara istek üzere teknik dosyayı hazırlamaya yetkili olan kişinin adı ve adresi:
BG: Име и адрес на лицето, упълномощено да състави техническия документ за властите при поискване:
RO: Numele și adresa persoanei autorizate să completeze dosarul tehnic pentru autorități la cerere:
SR: Ime i adresa lica ovlašćenog za sastavljanje tehničkog dokumenta za nadležnu instituciju u slučaju zahteva:
LV: Tās personas uzvārds un adrese, kura pilnvarota sagatavot tehnisko dokumentāciju pēc uzraugošo iestāžu pieprasījuma:
LT: Asmens, įgalioto valdžios institucijoms pareikalavus sudaryti techninę bylą, vardas, pavardė ir adresas:
RU: Ф.И.О и адрес лица, уполномоченного составлять техническую документацию по требованию органов власти:
HR: Ime i adresa ovlaštene osobe za sastavljanje tehničke dokumentacije nadležnoj instituciji u slučaju zahtjeva:

Frank Ennenbach, Director Product Safety and Regulations Sulzer Management AG, Neuwiesenstrasse 15, 8401 Winterthur, Switzerland



- EN:** We declare under our sole responsibility that the product to which this manual and declaration relates are in conformity with the following standards or other normative documents.
- DE:** Wir erklären in alleiniger Verantwortung, dass das Produkt, auf das sich dieses Handbuch und diese Erklärung beziehen, den folgenden Normen oder anderen normativen Dokumenten entspricht.
- FR:** Nous déclarons sous notre seule responsabilité que le produit auquel ce manuel et cette déclaration font référence est conforme aux normes ou autres documents normatifs suivants.
- ES:** Por la presente, nosotros declaramos bajo nuestra exclusiva responsabilidad que el producto al que se refiere este manual y declaración cumple con las siguientes normas u otros documentos normativos.
- PT:** Declaramos, sob nossa exclusiva responsabilidade, que o produto com o qual este manual e declaração estão relacionados se encontra em conformidade com as seguintes normas ou outros documentos normativos.
- IT:** Dichiariamo sotto la nostra esclusiva responsabilità che il prodotto a cui si riferisce questo manuale e la presente dichiarazione sono conformi ai seguenti standard o ad altri documenti normativi.
- NL:** Wij verklaren onder onze volledige verantwoordelijkheid dat het product, waar deze handleiding en verklaring bijhoren, voldoet aan de volgende normen of andere normatieve documenten.
- SV:** Vi intygar på eget ansvar att produkten som denna bruksanvisning och försäkran gäller uppfyller följande standarder eller andra normgivande dokument.
- NO:** Vi erklærer med vårt eneansvar at produktet som denne håndboken og erklæringen gjelder er i samsvar med følgende standarder eller andre normative dokumenter.
- DA:** Vi erklærer under eneansvar, at det produkt, som denne manual og erklæring vedrører, er i overensstemmelse med følgende standarder eller andre normgivende dokumenter.
- FI:** Me vakuutamme yksinomaisena vastuullisena, että tuote, jota tämä käsikirja ja vakuutus koskee, vastaa seuraavia standardeja tai muita ohjeellisia asiakirjoja.
- PL:** Deklarujemy na swoją wyłączną odpowiedzialność, że produkt, do którego odnosi się niniejsza instrukcja obsługi i deklaracja, jest zgodny z poniższymi normami lub innymi aktami normatywnymi.
- HU:** Teljes felelősségünk tudatában kijelentjük, hogy a termék, amelyre a jelen kézikönyv és nyilatkozat vonatkozik, megfelel az alábbi szabványoknak vagy egyéb normatív dokumentumoknak.
- EL:** Δηλώνουμε με αποκλειστική μας ευθύνη ότι το προϊόν στο οποίο αναφέρεται το παρόν εγχειρίδιο και η δήλωση βρίσκεται σε συμμόρφωση με τα ακόλουθα πρότυπα ή άλλα κανονιστικά έγγραφα.
- ET:** Kinnitame oma ainuvastutusel, et toode, mida see juhend ja deklaratsioon käsitleb, on kooskõlas järgmistega standardite või muude normdokumentidega.
- CS:** Prohlašujeme na naši výhradní odpovědnost, že produkt, ke kterému se vztahuje tento návod a prohlášení, je ve shodě s následujícími normami nebo jinými normativními dokumenty.
- SL:** Izjavljamo pod lastno odgovornostjo, da je izdelek, na katerega se nanašata ta priročnik in izjava, skladen z naslednjimi standardi ali drugimi normativnimi dokumenti.
- SK:** Vyhlasujeme na vlastnú zodpovednosť, že produkt, ktorého sa týka tento návod a vyhlásenie, je v zhode s nasledujúcimi normami a normatívnymi dokumentmi.
- TR:** Bu el kitabının ve beyanın konusu olan ürünün, aşağıdaki standartlara ve standartlara tabi diğer dokümanlara uygun olduğunu, tüm sorumluluk bize ait olmak üzere beyan ederiz.
- BG:** Декларираме на собствена отговорност, че продуктът, за който се отнася това ръководство и тази декларация, е в съответствие със следните стандарти или други нормативни документи.
- RO:** Declarăm pe propria răspundere că produsul la care fac referire acest manual și această declarație este în conformitate cu următoarele standarde sau alte documente normative.
- SR:** Na svoju isključivu odgovornost izjavljujemo da su proizvodi na koje se odnose ovaj priručnik i izjava u skladu sa sledećim standardima ili drugim normativnim dokumentima.
- LV:** Vienīgi uz savu atbildību deklarējam, ka izstrādājums, uz kuru attiecas šī rokasgrāmata un deklarācija, atbilst šādiem standartiem un citiem normatīvajiem aktiem.
- LT:** Deklaruojame savo atsakomybe, kad produktas, su kuriuo susijęs šis vadovas ir deklaracija, atitinka toliau nurodytus standartus ar kitus norminius dokumentus.
- RU:** Под нашу полную ответственность заявляем, что продукт, к которому относится данное руководство и декларация, соответствует следующим стандартам или другим нормативным документам.
- HR:** Izjavljujemo pod vlastitom odgovornosti da je proizvod na koji se ovaj priručnik i ova izjava odnose usklađen sa sledećim normama ili drugim normativnim dokumentima



- EN:** As defined by ATEX Directive 2014/34/EU, Machinery Directive 2006/42/EC, EMC-Directive 2004/108/EC, Low Voltage Directive 2014/35/EU, Outdoor Noise Directive 2000/14/EC amended by 2005/88/EC.
- DE:** Im Sinne der ATEX-Richtlinie 2014/34/EU Maschinenrichtlinie 2006/42/EG, EMV-Richtlinie 2004/108/EG, Niederspannungsrichtlinie 2014/35/EU, Lärmrichtlinie 2000/14/EG geändert durch 2005/88/EG.
- FR:** Tel que défini par la directive ATEX 2014/34/EU, Directive sur les machines 2006/42/CE, EMC-Directive 2004/108/CE, Directive basse tension 2014/35/EU, Directive sur le bruit extérieur 2000/14/CE amendé par 2005/88/EC.
- ES:** Según se define en la Directiva ATEX 2014/34/UE, Directiva de Máquinas 2006/42/CE, DIRECTIVA EMC 2004/108/CE, Directiva de Baja Tensión 2014/35/UE, Directiva 2000/14/CE modificada por 2005/88/CE.
- PT:** Conforme definido pela diretiva ATEX 2014/34/UE, diretiva de máquinas 2006/42/CE, Diretiva EMC 2004/108/CE, diretiva de baixa tensão 2014/35/UE, diretiva ruído exterior 2000/14/CE alterada por 2005/88/CE.
- IT:** Come definito dalla direttiva ATEX 2014/34/EU, direttiva sulle macchine 2006/42/EC, Direttiva EMC 2004/108/EC, direttiva a bassa tensione 2014/35/UE, direttiva sul rumore esterno 2000/14/EC modificata entro il 2005/88/EC.
- NL:** Zoals gedefinieerd in ATEX richtlijn 2014/34/EU, Machinerichtlijn 2006/42/EG, EMC-richtlijn 2004/108/EG, laagspanningsrichtlijn 2014/35/EU, buitenlawaai Richtlijn 2000/14/EG gewijzigd tegen 2005/88/EG.
- SV:** Enligt definitionen i ATEX-direktivet 2014/34/EU, maskin direktiv 2006/42/EG, EMC-direktiv 2004/108/EG, lågspännings direktivet 2014/35/EU, direktiv 2000/14/EG om buller, ändrat genom 2005/88/EG.
- NO:** Som definert av ATEX-direktiv 2014/34/EU, maskindirektiv 2006/42/EF, EMC-direktiv 2004/108/EF, lavspenningsdirektiv 2014/35/EU, direktiv om utendørs støy 2000/14/EF endret av 2005/88/EF.
- DA:** Som defineret i ATEX-direktiv 2014/34/EU, maskindirektiv 2006/42/EF, EMC-direktiv 2004/108/EF, lavspændingsdirektiv 2014/35/EU, direktiv vedr. udendørs støj 2000/14/EF revideret ved 2005/88/EF.
- FI:** kuten ATEX-direktiivissä 2014/34/EU on määritelty, kone direktiivi 2006/42/EY, EMC-direktiivi 2004/108/EY, pien jännite direktiivi 2014/35/EU, ulkomelu direktiivi 2000/14/EY, sellaisena kuin se on muutettuna direktiivillä 2005/88/EY.
- PL:** zgodnie z definicją zawartą w dyrektywie ATEX 2014/34/UE Dyrektywa maszynowa 2006/42/WE, dyrektywa EMC 2004/108/WE, dyrektywa niskonapięciowa 2014/35/UE, dyrektywa w sprawie hałasu na zewnątrz 2000/14/WE zmieniona dyrektywą 2005/88/WE, dyrektywa 2009/125/WE.
- HU:** A 2014/34/EU, ATEX-irányelv, a 2006/42/EK gépekről szóló irányelv, a 2004/108/EK EMC-irányelv, a 2014/35/EU kifizetésű irányelv és a kültéri zajkibocsátás 2005/88/EK irányelvvél módosított 2000/14/EK irányelve által meghatározottak szerint.
- EL:** όπως ορίζεται από την οδηγία 2014/34/EE του ATEX, οδηγία για τις μηχανές 2006/42/EK, EMC-Οδηγία 2004/108/EK, οδηγία για την χαμηλή τάση 2014/35/EE, οδηγία 2000/14/EK για το θόρυβο, τροποποιήθηκε από το 2005/88/EK.
- ET:** Kooskõlas ATEX-direktiiviga 2014/34/EL, masinadirektiiviga 2006/42/EÜ, elektromagnetilise ühilduvuse direktiiviga 2004/108/EÜ, madalpingedirektiiviga 2014/35/EL, välismüra direktiiviga 2000/14/EÜ, mida on muudetud direktiiviga 2005/88/EÜ.
- CS:** Podle definice ve směrnici ATEX 2014/34/EU, směrnici o strojních zařízeních 2006/42/ES, směrnici o elektromagnetické kompatibilitě 2004/108/ES, směrnici o nízkém napětí 2014/35/EU, směrnici o venkovním hluku 2000/14/ES ve znění směrnice 2005/88/ES.
- SL:** Kot opredeljujejo Direktiva ATEX 2014/34/EU, Direktiva o strojih 2006/42/ES, Direktiva o elektromagnetni združljivosti 2004/108/ES, Direktiva o nizki napetosti 2014/35/EU, Direktiva 2000/14/ES o emisijah hrupa v okolje, kot jo spreminja Direktiva 2005/88/ES.
- SK:** Ako je definované smernicou 2014/34/EU ATEX, smernicou 2006/42/EC o strojových zariadeniach, smernicou 2004/108/EC o elektromagnetickej kompatibilite, smernicou 2014/35/EU o nízkom napätí, smernicou 2000/14/EC o hluku vo vonkajšom prostredí zmenenou a doplnenou smernicou 2005/88/EC.
- TR:** ATEX Yönetmeliği 2014/34/AB, Makine Emniyeti Yönetmeliği 2006/42/AT, EMU Yönetmeliği 2004/108/AT, Alçak Gerilim Yönetmeliği 2014/35/AB, Gürültü Yönetmeliği 2000/14/AT (yerine 2005/88/AT yürürlüğe girmiştir) doğrultusunda.
- BG:** Както е определено в Директива ATEX 2014/34/EC, Директива 2006/42/EO относно машините, Директива 2004/108/EO относно EMC, Директива 2014/35/EC относно ниското напрежение, Директива 2000/14/EO относно шума на открито, изменена с Директива 2005/88/EO.
- RO:** În conformitate cu Directiva ATEX 2014/34/UE, Directiva privind echipamentele tehnice 2006/42/CE, Directiva CEM 2004/108/CE, Directiva privind tensiunea joasă 2014/35/UE, Directiva privind zgomotul exterior 2000/14/CE, modificată prin 2005/88/CE.
- SR:** Kao što je definisano ATEX Direktivom 2014/34/EU, Direktivom o mašinama 2006/42/EK, Direktivom o EMK 2004/108/EK, Direktivi za električne uređaje niskog napona 2014/35/EU, Direktivi o emisiji buke opreme koja se koristi na otvorenom prostoru 2000/14/EK koju zamenjuje 2005/88/EK.
- LV:** Saskaņā ar ATEX direktīvu 2014/34/ES, Mašīnu direktīvu 2006/42/EK, EMS direktīvu 2004/108/EK, Zemsprieguma direktīvu 2014/35/ES, Trokšņu direktīvu 2000/14/EK, kas grozīta ar 2005/88/EK.
- LT:** Kaip apibrėžta ATEX direktyvoje 2014/34/ES, Mašinų direktyvoje 2006/42/EB, EMC direktyvoje 2004/108/EB, Žemos įtampos direktyvoje 2014/35/ES, Išorinio triukšmo direktyvoje 2000/14/EB, iš dalies pakeistoje 2005/88/EB.
- RU:** Как определено директивой ATEX 2014/34/EU, Директива о машиностроении 2006/42/EC, EMC-Directive 2004/108/EC, Директива о низком напряжении 2014/35/EU, Директива об уличном шуме 2000/14/EC с поправками к 2005/88/EC.
- HR:** U skladu s Direktivom ATEX 2014/34/EU, Direktivom o strojevima 2006/42/EZ, Direktivom EMC 2004/108/EZ, Direktiva o niskonaponskoj opremi 2014/35/EU, Direktivom o vanjskoj buci 2000/14/EZ dopunjenoj s 2005/88/EZ.

EN ISO 12100-1, EN ISO 12100-2, IEC 80079-36, IEC 80079-37

Gregory B. Queen, President
JWC Environmental Inc.
11-12-2019

Table of contents

ATEX warning statements  (refer to nameplate to check if applicable)	1
Nameplate details	2
Safety and hazard warnings	3
General information	4
Intended use	4
Limitation of use	5
Torque settings	6
Safety recommendations	6
Noise levels	6
Lubrication	7
Handling	7
Use of items not approved or manufactured by Sulzer	7
Inspection / Storage	7
Installation	8
Earth bonding [explosion-proof grinders only]	9
Electrical installation	9
Guards	10
Warning / Control device	10
Start-up procedure	10
Dismantling advice	11
Cleaning / Inspection	11
Re-assembly advice	12
Extended shutdown	12
Maintenance	12
Lubrication table	13
Allowable wear tolerances	13
Troubleshooting	14

ATEX warning statements (refer to nameplate to check if applicable)

1. Where a grinder is to be installed in a potentially explosive atmosphere ensure that this has been specified at the time of purchase and that the equipment has been supplied accordingly and displays an ATEX nameplate or is supplied with a certificate of conformity. If there is any doubt as to the suitability of the equipment, please contact Sulzer before commencing with installation and commissioning.
2. Process liquids or fluids must be kept within -20°C – 40°C, otherwise the surface of grinder or system components may become an ignition source due to temperature rises.
3. Electrical installation and maintenance work should only be carried out by suitably qualified and competent persons and must be in accordance with relevant electrical regulations.
4. If there is a risk of an accumulation of explosive gases or dust, proper ventilation must be performed before and during operation, removing all gases and dust.
5. When fitting drives, couplings, and guards to a grinder unit it is essential that these are correctly fitted, aligned and adjusted in accordance with the installation instructions. Failure to do so may result in sparking due to unintended mechanical contact, or temperature rises due to mechanical or electrical overload.
6. Failure to operate or maintain the grinder and ancillary equipment in line with the manufacturer's instructions may lead to premature and potentially dangerous failure of components. Regular inspection, and where necessary, replacement of bearings, seals, other wearing parts and lubrication is essential.

For unit specific ATEX grinder arrangement drawings, please use the following table to ensure you have the correct unit drawing for reference.

JWC/Sulzer unit drawings & ATEX certification data		
Drawing no.	Unit description	ATEX zone
10000-CD-ATEX-S	10K Inline Series Muffin Monster	Gas & Dust
10002-CD-ATEX-S	10K Channel Series Muffin Monster	Gas & Dust
30002-SC2-ATEX-S	3-SHRED Series Muffin Monster	Gas & Dust
30004T-CD-ATEX-S	30K Inline Series Muffin Monster	Gas & Dust
30005-CD-ATEX-S	30K Channel Series Muffin Monster	Gas & Dust
40002-CD-ATEX-S	40K Channel Series Muffin Monster	Gas & Dust
40002-IL-CD-ATEX-S	40K Inline Series Muffin Monster	Gas & Dust
40002-SC2-ATEX-S	4-SHRED-Series Muffin Monster	Gas & Dust
CMD-XDS2.0-ATEX-S	CMD-XDS2.0 Channel Monster Series	Gas Only
CMD-XDM2.0-ATEX-S	CMD-XDM2.0 Channel Monster Series	Gas Only
CDD-XDS2.0-ATEX-S	CDD-XDS2.0 Channel Monster Series	Gas Only
CDD-XDM2.0-ATEX-S	CDD-XDM2.0 Channel Monster Series	Gas Only
CDD-XDS2.5-ATEX-S	CDD-XDS2.5 Channel Monster Series	Gas Only
CDD-XDM2.5-ATEX-S	CDD-XDM2.5 Channel Monster Series	Gas Only

Nameplate details

Non ATEX

		JWC ENVIRONMENTAL CONGLETON, CHESHIRE CW12 1UN, U.K.			
<small>THIS PRODUCT IS COVERED BY ONE OR MORE U.S. PATENTS AND FOREIGN COUNTERPARTS 6,176,443 6,332,984 7,073,433 7,081,405 7,383,942 7,771,589 9,421,550</small>					
MODEL NO.	[]		CODE	[]	
SERIAL NO.	MANUF. DATE	CAPACITY m ³ /h	MAX. kpa	WEIGHT kg	
[]	[]	[]	[]	[]	
SOUND PRESSURE LEVEL <70dB					

**Muffin Monster
Gas & Dust**

		JWC ENVIRONMENTAL CONGLETON, CHESHIRE CW12 1UN, U.K.			
<small>THIS PRODUCT IS COVERED BY ONE OR MORE U.S. PATENTS AND FOREIGN COUNTERPARTS 6,176,443 6,332,984 7,073,433 7,081,405 7,383,942 7,771,589 9,421,550</small>					
<small>II 2G Ex h IIB T4 Gb II 3D Ex h IIIC T135C Dc</small>					
MODEL NO.	[]		CODE	[]	
SERIAL NO.	MANUF. DATE	CAPACITY m ³ /h	MAX. kpa	WEIGHT kg	
[]	[]	[]	[]	[]	
Certificate No: Baseefa03ATEX0591X/2			SOUND PRESSURE LEVEL <70dB		

**Channel Monster
Gas Only**

		JWC ENVIRONMENTAL CONGLETON, CHESHIRE CW12 1UN, U.K.			
<small>THIS PRODUCT IS COVERED BY ONE OR MORE U.S. PATENTS AND FOREIGN COUNTERPARTS 6,176,443 6,332,984 7,073,433 7,081,405 7,383,942 7,771,589 9,421,550</small>					
<small>II 2G Ex h IIB T4 Gb</small>					
MODEL NO.	[]		CODE	[]	
SERIAL NO.	MANUF. DATE	CAPACITY m ³ /h	MAX. kpa	WEIGHT kg	
[]	[]	[]	[]	[]	
Certificate No: Baseefa03ATEX0591X/2			SOUND PRESSURE LEVEL <70dB		

- II Equipment Group - Surface
- 2/3 ATEX Category – High Protection
- G/D Gas/Dust
- Ex Explosion Proof
- h Mechanical Equipment, assigned protection group per EN80079-36
- IIB/IIIC Gas/Dust Group
- T Temperature Class
- Gb/Dc Equipment Protection Level (Gas-1, Dust-22)

Safety and hazard warnings



Presence of dangerous voltage.



Non-compliance may result in personal injury.



Lock out – Tag out notification. Electrical hazard – non-compliance may result in personal injury.



Keep clear of rotating components.



Auto-restart of rotating components may occur after power loss if the main isolator is not off.



Suspended load. Do not stand under the grinder during installation / removal.



Wear safety shoes when handling components.



Sharp edges. Wear safety gloves when handling grinder cutters and spacers.



Wear eye protection when cleaning components.



The grinder must rotate in the correct direction for proper operation. This must be checked on installation and commissioning and after any maintenance has been carried out. Failure to observe this may lead to mechanical or electrical overload.

General information

The grinder reduces solids in sewage. A separate control panel provides grinder controls. These instructions address the following models.

Model	Cutter stack height (mm)
30005-0008	200 mm
30005-0012	300 mm
30005-0018	450 mm
30005-0024	600 mm
30005-0032	800 mm
30005-0040	1000 mm
30005-0050	1270 mm
30005-0060	1500 mm

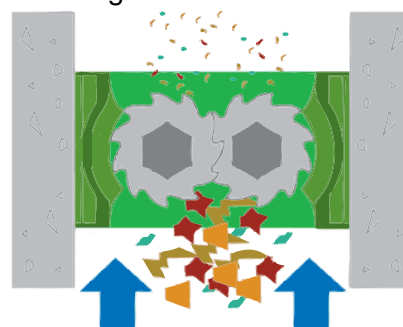

Model	Weight (kg)*	Model	Weight (kg)*
30005-0008	80 kg	30005-0032	225 kg
30005-0012	140 kg	30005-0040	265 kg
30005-0018	155 kg	30005-0050	285 kg
30005-0024	185 kg	30005-0060	338 kg

*less drive

Drive assembly weights (kg)							
Reducer only				Motor only			
IP55		IP68		IP55		IP68	
2.2 kW	4.0 kW	2.2 kW	4.0 kW	2.2 kW	4.0 kW	2.2 kW	4.0 kW
31 kg		36 kg	38 kg	32 kg	44 kg	84 kg	159 kg

Intended use

The 30005 series open channel grinder has been designed for the economical and reliable particle reduction for commercial, industrial and municipal sewage.

They are suitable for processing the following material:

- Clear and wastewater for sewage containing solids and fibrous material
- Faecal matter
- Sludge
- Sewage

Limitation of use

Limits of the machine									
Description	Twin-shafted grinder with cutters and spacers enclosed in a cast iron housing meeting various standards, speed reducer, electric motor and motor controller								
Maximum flow rate	<table border="0"> <tr> <td>30005-0008 – 84 m³/hr</td> <td>30005-0032 – 477 m³/hr</td> </tr> <tr> <td>30005-0012 – 141 m³/hr</td> <td>30005-0040 – 686 m³/hr</td> </tr> <tr> <td>30005-0018 – 223 m³/hr</td> <td>30005-0050 – 979 m³/hr</td> </tr> <tr> <td>30005-0024 – 311 m³/hr</td> <td>30005-0060 - 1277 m³/hr</td> </tr> </table>	30005-0008 – 84 m ³ /hr	30005-0032 – 477 m ³ /hr	30005-0012 – 141 m ³ /hr	30005-0040 – 686 m ³ /hr	30005-0018 – 223 m ³ /hr	30005-0050 – 979 m ³ /hr	30005-0024 – 311 m ³ /hr	30005-0060 - 1277 m ³ /hr
30005-0008 – 84 m ³ /hr	30005-0032 – 477 m ³ /hr								
30005-0012 – 141 m ³ /hr	30005-0040 – 686 m ³ /hr								
30005-0018 – 223 m ³ /hr	30005-0050 – 979 m ³ /hr								
30005-0024 – 311 m ³ /hr	30005-0060 - 1277 m ³ /hr								
Maximum process pressure	6 bar								
Personnel information									
Anticipated level of training, ability and experience	Applicable local, federal and area safety rules, regulations and guidelines; discipline-specific apprenticeship/training								
Special physical requirements	N/A								
Personnel affected	Installers, electricians, operators, maintenance personnel								
Environmental limits									
Temperature	Operation: -5° C to +40° C Storage: -40° C to +65° C								
Humidity	IP68								
Elevation	1000 metres above sea level								
Space limits									
Clearance required for operation	150mm over motor fan cover 914mm in front of controller								
Clearance required for maintenance	610mm above 914mm on left or right side of grinder 914mm in front of controller								
Interface limits									
Electrical	575V/3PH/60HZ 400V/3PH/50HZ								
Water	N/A								
Hydraulic	N/A								
Connection to other equipment	Two (2) dry-contact relays indicating grinder Run and Fail conditions for remotely located monitoring operation powered by foreign sources								

Torque settings

Torque settings (Nm)			
10K grinder			
Thread	8.8 ZP	18-8 SST	Cutter stack locking nuts
M6	12	8.7	
M8	30	21.2	
M10	55	42	
1 in.			170
30K, 40K, CMD, CDD grinder			
1/4 in.		8.5	
5/16 in.		14.9	
3/8 in.		26.7	
1/2 in.		58	
9/16 in.		75.9	
5/8 in.		124.7	
1-1/2 in.			224

Safety recommendations

In common with other items of process plant a grinder must be installed correctly to ensure satisfactory and safe operation (refer to the Installation section). The grinder must also be maintained to a suitable standard (refer to the Maintenance section). Following these recommendations will ensure that the safety of personnel and satisfactory operation of the grinder is achieved.

When handling harmful or objectional materials, adequate ventilation must be provided in order to disperse dangerous concentrations of vapours. It is recommended that where possible, Sulzer grinders should be installed with provision for adequate lighting, thus ensure that effective maintenance can be carried out in satisfactory conditions. With certain product materials, a hosing down facility with adequate draining will simplify maintenance and prolong the life of grinder components.

Noise levels

The sound pressure level will not exceed 70 dB at one metre distance from the grinder. This is based on a typical installation and does not necessarily include noise from other sources or any contribution from building reverberation.

Lubrication

At 10,000 hr intervals, bearings, gears and seal assembly inspection should take place along with gear grease replenishment.

Under tropical or other arduous conditions, however, more frequent lubrication may be necessary. It is therefore advisable to establish a suitable maintenance schedule or periodic inspection to match service conditions.

Handling



During installation and maintenance, attention must be paid to the safe handling of all items. Where a grinder or its components weigh in excess of 20 kg (45 lb) it is recommended that suitable lifting tackle should be used to ensure that personal injury or damage to components does not occur.



Do not attempt to lift the grinder using only one lifting point. Extreme caution should be observed for personnel safety when lifting heavy objects.



By design the cutters have sharp edges. Great care must be taken when handling. The use of protective gloves is recommended.

Use of items not approved or manufactured by Sulzer

The grinder and its components have been designed to ensure that the grinder will operate safely within the guidelines covered by legislation. As a consequence, Sulzer has declared the machine safe to use for the duty specified as defined by the Declaration of Conformity and the Intended Use that is issued with this instruction manual.

The use of replacement items that are not approved by or manufactured by Sulzer may affect the safe operation of the grinder and it may therefore become a safety hazard to both operators and other equipment. In these instances, the declaration provided will therefore become invalid. The guarantee referenced in the Terms and Conditions of Sale will also be invalidated if replacement items are used that are not approved or manufactured by Sulzer.

Inspection / Storage

Report container damage to the carrier and Sulzer.

Contact Sulzer or representative for missing, loose, or damaged parts.

All equipment should be stored in a controlled dry environment to prevent corrosion or damage to components.

Grinders are dispatched from our factory with the cutter chamber sprayed with a moisture repellent coating and ready for immediate installation and operation.

Should the machine be stored or left stationary for any length of time it is recommended that the cutter stack is re-sprayed with anti-rust lubricant and that the shafts are rotated for 1-5 minutes every 3 months either by hand or applying power to the drive motor. Check for grinder drive lubricant leakage. Contact Sulzer if leakage exceeds 6ml.

Failure to do the above may cause the machine to seize due to the tight running clearances of the individual cutting elements during commissioning and initial start-up.

Prior to installation/commissioning:

- Check external hardware as gasketed areas may have a tendency to loosen fasteners. Retighten if loose (refer to Torque settings).
- Check paint for any slight damage and touch up if necessary. Standard Sulzer colour (RAL 5002).

Installation



Electrical, mechanical and maintenance work should only be performed by suitably qualified and competent persons and must be in accordance with relevant electrical and mechanical regulations.



Be sure to use both lifting eyes

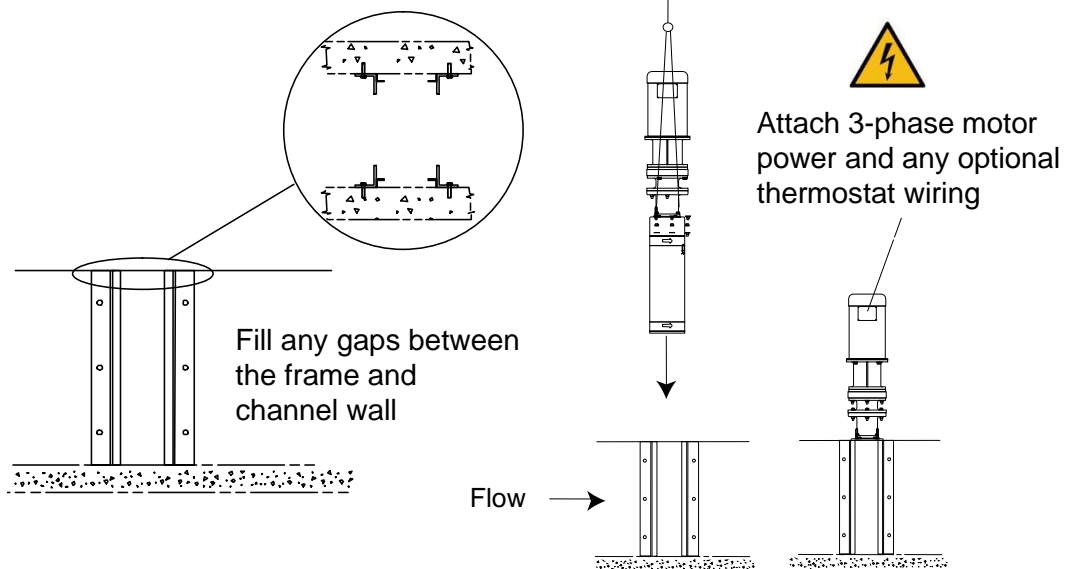

Grinder Installation

Earth bonding [explosion-proof grinders only]

The grinder and associated motor are equipped with threaded studs for installations requiring single point earth bonding. Use a cable meeting local wiring requirements and attach it to the two earth bonding lugs located on the motor housing and grinder top cover.



Typical earth bonding points for grinder and drive. To be connected to local earthing points on installation. To be carried out by suitably qualified installation contractor and following local country requirements and legislation. Earth bonding cables not supplied.

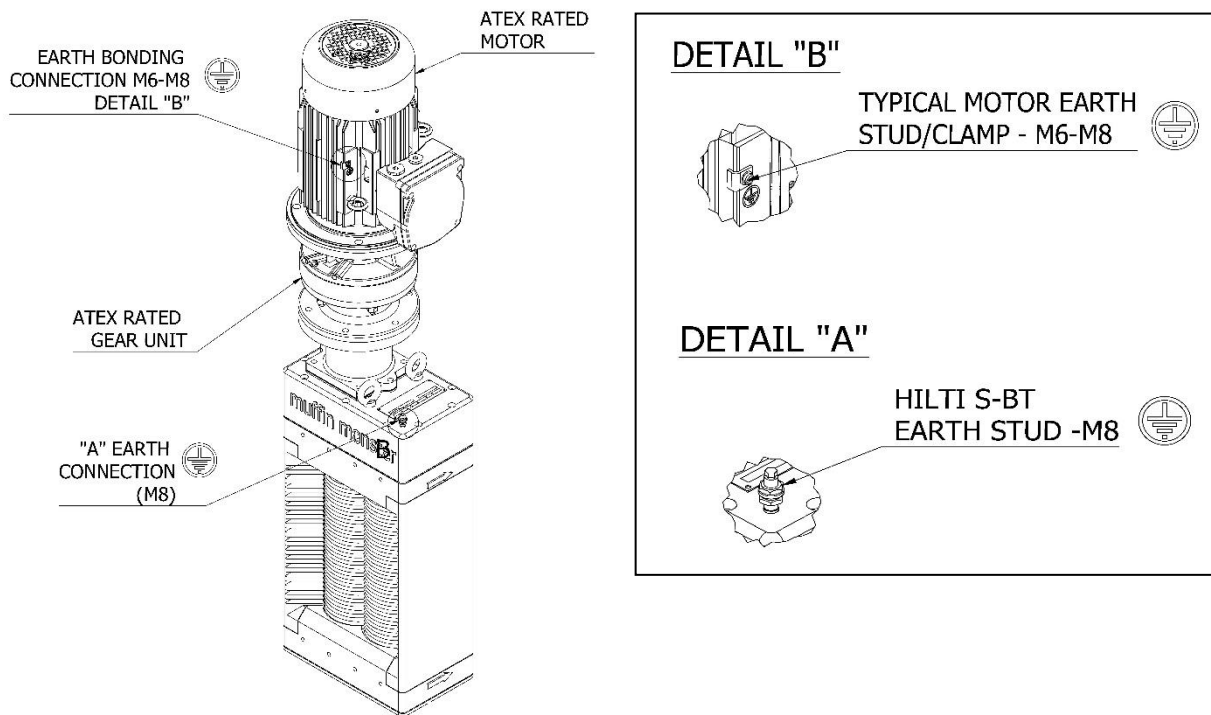

Electrical installation



The grinder is protected by a PLC control unit set to the correct operating philosophy. Only PLCs supplied or approved by Sulzer should be used. Failure to observe this requirement may cause premature machine failure and could invalidate the warranty of the machine. It is also important that the PLC be correctly wired into the panel (refer to the Controller Manual if controller is supplied).



Before installing the grinder please ensure that all plugs and inspection plates are replaced.



Electrical connection should only be made using equipment suitable for both rating and environment. Where any doubts exist regarding the suitability of equipment, Sulzer should be consulted before proceeding. Earthing points will be provided on ATEX rated electric drives (if supplied) and it is essential that these are correctly connected. The electrical installation should include appropriate isolating equipment to ensure that the grinder and drive assembly is safe to work on.

Guards



In the interests of safety, all guards must be replaced after necessary adjustments have been made to the grinder.

Warning / Control device

Prior to operating the grinder, if any warning or control devices are fitted, these must be set in accordance with their specific instructions.



Sulzer is not liable if local or international regulations are not followed or for damage caused by wiring errors or improper shielding. Use lifting equipment rated for the weight of the grinder minimum attached to all the grinder top cover lifting rings as shown to lift the grinder. Verify the grinder flow arrows, located on the side of the grinder, point in the direction of flow.

Start-up procedure



By the nature of the equipment and its operating environment the grinder can be an extremely dangerous machine. It is vital that operators are conversant with these installation and operating instructions prior to working with the machine.



Verify there is no unauthorized personnel or materials near the grinder.

Use a control panel rated for the grinder motor voltage, amps, frequency with a suitable power disconnect and overtemp protection if the motor has a thermostat.

Apply power to grinder with the control panel control switch.

Check for proper motor or shaft rotation. Disconnect power and interchange any two motor leads if reversed. Gradually apply flow. Verify reduction of solids.

Where applicable:

1. Check all installation hardware once the machine is installed in its correct operating position.
2. Check all electrical connections for continuity and earthing and that installation is in accordance with relevant regulations and circuit diagrams.
3. Always ensure that the machine is guarded in accordance with local health and safety requirements.
4. Apply power to grinder with the control panel control switch.
5. On start-up check the direction of rotation of the cutters. The cutters should rotate towards the centre when viewed from the inlet side.
6. Check that the grinder stops when the stop operation is activated.
7. Start up the machine and gradually start the feed system to the machine. Care should be taken not to overburden the machine. Adjust feed to maintain only the smallest practical reservoir of material in cutter stack.

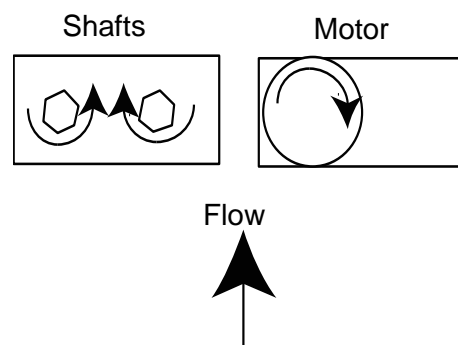

8. After a further 10 minutes of running, stop the machine, switch off and lock the main isolator. Check the tightness of all securing bolts. Re-check every 500 hours of operating time.
9. Check the tightness of all cables and connections. Re-check every 500 hours of operating time.
10. Observe manufacturer’s guidelines with regard to gearbox lubricant initial renewal and subsequent intervals.
11. In the event of machine overload (jam), the controller is programmed to activate the following procedure:
 - i. Momentarily reverse rotation to clear the condition, then return to normal operation.
 - ii. If overload re-occurs within 60 seconds, reverse rotation to clear the condition, then return to normal operation.
 - iii. If a third overload occurs within 60 seconds of the first, machine shuts down and energises an alarm circuit.
12. After machine shutdown, relieve pressure, isolate, and lock off. Inspect machine, remove any obstruction and reset the controller.
13. The machine can now be re-started.

Dismantling advice



When servicing the grinder, be certain that the main isolator is tagged out / locked out. Serious injury could result from accidental start-up.

1. Disconnect wiring at motor(s) terminal box(es) and tag leads for identification.
2. Isolate the grinder from influent.
3. If necessary, the grinder may be completely removed from installation using the recommended lifting equipment.
4. Replace the cutter stack with the maintenance screen if required.

Cleaning / Inspection

It is important to periodically inspect the grinder (timeframe dependent on usage).

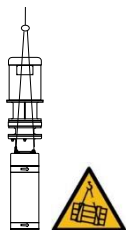

Attach lifting equipment and remove the grinder



1. Steam clean and disinfect all parts of the unit excluding motor, seal assemblies, gear drive unit and bearings.
2. Remove any gasket material from joint faces.
3. Housings should be cleaned thoroughly.
4. Inspect all parts for excessive wear.
5. Inspect gears for wear and damage.

- 6. All cutters and spacers must be clean and free from cracks or excessive wear.
- 7. Shafts should be clean and any burrs filed off for easier stacking. Inspect shafts for excessive wear of hexagonal portion.

Contact the Sulzer service department if any of the above requires replacement.

Re-assembly advice

- 1. Lubricate gears on re-assembly with the specified lubricant.
- 2. Re-connect wiring at motor(s) terminal box(es) using tag leads for identification.
- 3. Re-open system isolation valves.
- 4. On completion of assembly, run through the 'initial start-up' procedure.

Extended shutdown

For extended shutdown refer to the Inspection / Storage section.

Maintenance

For service or parts please contact your Sulzer representative. DO NOT attempt service other than that described in this section.



Remove and lock out supply power.

After first 3 months, then every 6 months or if solids not processed:



Check cutters and yoke assembly (if fitted) for wear. Edges of the cutters should not be rounded. (See Allowable wear tolerances.)



Check cutter stack tightness.

If loose or worn, refer to Troubleshooting.

Every 6 months add grease to the intermediate yoke assembly (if fitted).

Every 12 months routine maintenance should be carried out.



Check cutter stack tightness and cutters for wear.



Remove drive assembly, then remove top and bottom covers. If top or bottom seals housings are contaminated with effluent, contact your local Sulzer service centre.



Prior to refitting top and bottoms covers, fit new gaskets.



Every 5 years:

- Remove drive assembly, top cover and old grease (see figure).
- Inspect gears for damage or wear, replace if necessary, then replenish grease (see Lubrication table).

Top Cover and Gears

Lubrication table

Manufacturer	Lubricant
Gear grease (do not mix) 500 grams	
Ormskirk	Total Multis Complex EP2*
Yoke grease (do not mix)	
Castrol	Spheerol LCX 6002 *
O-Ring grease	
Ironsides Lubricant Ltd	Silicon valve grease* 0250/0077
Rust inhibitor	
Solent	SOL-732-0620K spray*
General and protectant	
WD-40 Company	WD-40 aerosol lubricant*
* O.E.M. (Original Equipment Manufacturer)	

Allowable wear tolerances

Description	O/D	Thickness
Spacer	Maximal 0.20 mm	zero wear
Cutter	Maximal 0.63 mm	0.75 mm per side at edge of cutter See Cutter Wear figure below



Cutter Wear

Troubleshooting

Symptom	Check
Solids not reduced	Cutter rotation
	Cutters for wear
	Cutter stack tightness
	Grinder motor drive train
Loose cutter stack The unit must be stripped down	Seal cartridges for damage
	Cutters for wear
	Lock nuts loose
Excessive noise, vibration or reversals	Drive gears for wear
	Seal cartridges for contamination
Motor overload	Solids overloading
	Cutters for wear



SULZER

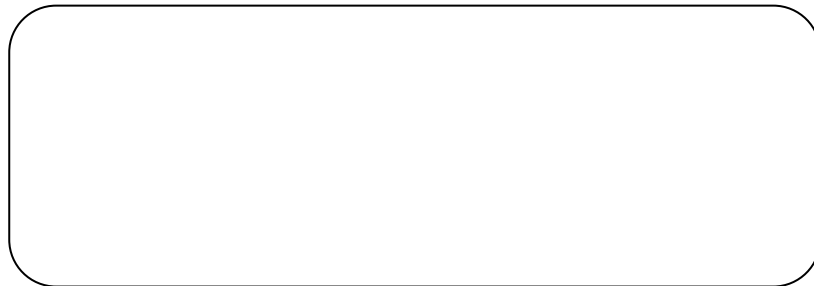

JWC Environmental · Unit 15, Daneside Business Park River Dane Road · Congleton,
Cheshire CW12 1UN United Kingdom · www.sulzer.com