

SULZER

High performance trays

Enhanced deck and downcomer technology

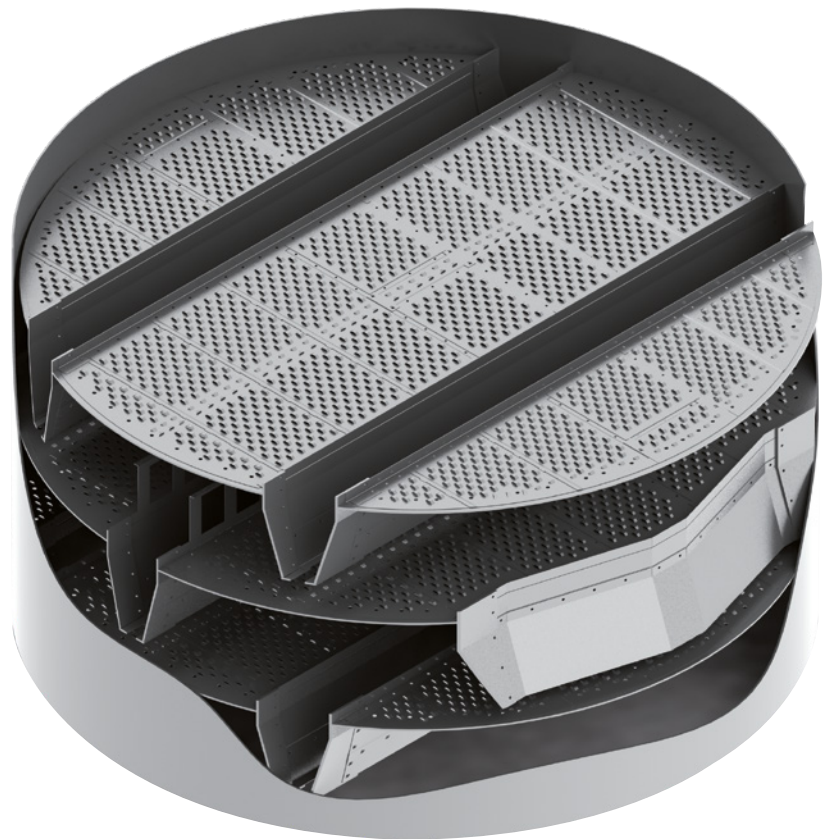

Sulzer Chemtech – Separation technology

Your partner in separation and mixing technology

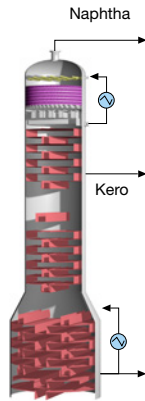

The highest level of application know-how

Our team provides expert knowledge for more than 500 applications in 100 processes, enabling us to optimize the performance and your installation.

Fast and reliable turnaround services

We don't shut-down, when you shut-down. You can rely on Sulzer professionals, expertise and procedures to get you back and running in the shortest possible time.

Comprehensive engineering and technology services

We provide a full scope of associated engineering and technology services to optimize or trouble-shoot your installation.

A broad range of innovative and high-performing products

More than 200 of our products cover a wide range of needs in the field of separation and mixing technology.

They have proven their performance in more than 100'000 columns, 50'000 gas/liquid or liquid/liquid separators and 100'000 static mixers in operations worldwide.



MellapakPlus™ Packing

Often copied, never equaled

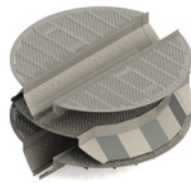

UFMPPlus™ trays

One of the best high performance trays ever tested at FRI



NeXRing™

The next big thing in random packing



SMV™ static mixer

High mixing efficiency combined with large turn-down processing capabilities



Dusec Plus™ Coalescer

High performance liquid/liquid coalescer

High performance trays

We understand the ever increasing requirement for both reliability and performance of your process equipment. To meet these challenges, you can rely on our innovative, industry-leading products and expertise. Our extensive tray portfolio ranges from single pass to multi-downcomer as well as conventional to high-performance, including the latest technology in ultra-system limit trays. All designs are tailored to meet the exact requirements of your specific application.

For your most demanding applications, our high performance trays include VGPlus™ trays with MVG™ decks and enhanced downcomer technology as well as the newest trays, UFMPlus™ with UFM™ valves. The UFM valve is an industrially proven, advanced movable mini valve providing the highest efficiency and capacity. For fouling applications, Sulzer has developed a new high performance anti-fouling valve UFM™ AF, which provides high capacity in addition to its superior fouling resistance. This portfolio has been greatly enriched since 2000 by our technology alliance with Shell Global Solutions, and also includes Shell high performance trays such as the SHELL HIFI* trays, ideal for high liquid load applications, and SHELL CONSEP* Plus trays with proven ultra-system capabilities.

Tray portfolio

Sulzer technology

Conventional trays		Chordal downcomer High performance trays	
Floating valves	Other orifices	Enhanced deck	Enhanced deck and downcomer
BDH™ / BDP™	Bubble Cap	Floating valves	VGPlus™
Round valves	Sieve	UFM™	UFMPlus™
Fixed valves	Counter flow trays	Fixed valves	
XVG™	Dual Flow	MVG™	
SVG™	Baffle	MMVG™	
SVG-H™	Shower Deck	UFM™ AF	
LVG™	Disc and Donut		
Slit Trays™			

Sulzer-Shell alliance

Multi downcomer High performance trays
SHELL HIFI* PLUS
SHELL HIFI*
SHELL CALMING* SECTION PLUS
SHELL CALMING* SECTION (CS)
Dual flow high performance trays
Shell CS* Grid
Ultra-system limit high performance trays
SHELL CONSEP* PLUS



High performance trays featured in this brochure

*) trademark owned and used by the companies of the Shell Group

Leading tray technology

In the 1820s, an early version of bubblecaps trays were introduced for continuous distillation towers.

In the 1950s, valve trays were developed, providing higher capacity and better efficiency over a wider operating range. The modern valve tray, a rectangular float valve tray, was first installed by I.E. Nutter in 1951. By 1956, different variations of round valves had surfaced.

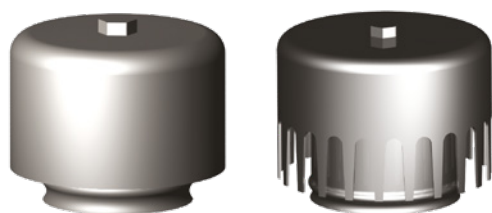

Bubblecaps in Sulzer's tray portfolio



Round valve

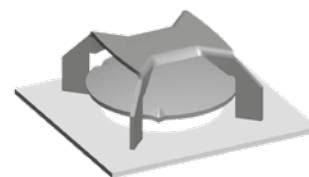

Caged valve



1800

1900

Modern 1-pass Sieve tray



In the 1830s, sieve trays were developed, offering higher capacity despite design simplicity.

BDH™ Rectangular float valve

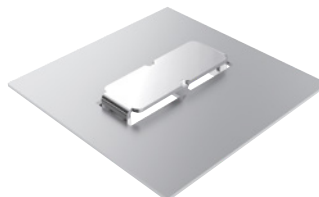

V-Grid Fixed valves from left to right: SVG™, MVG™ and MMVG™ Fixed valves



In 1998, Sulzer acquired Nutter Engineering, incorporating the well-acclaimed BDH™ rectangular float valve and V-Grid fixed valves into Sulzer's tray product portfolio.

In 2000, Sulzer formed a technology alliance with Shell Global Solutions providing a full range tray product portfolio from one source. These include Shell Calming Section (Plus) trays, Shell HiFi (Plus) trays and ultra-high capacity Shell ConSep Plus trays.

In 2012, Sulzer launched a new valve product – UFM, a movable valve which provides higher capacity and a wider operating range than conventional valves.

In 2014, Sulzer launched UFMPlus, a high performance tray with a UFM deck and enhanced downcomers.

In 2017, Sulzer also developed a high capacity anti-fouling valve UFM AF for fouling applications. Enhanced decks with UFM AF valves are part of UFMPlus tray family.

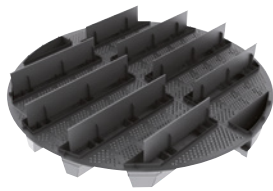

Shell HiFi tray



Shell ConSep Plus



UFM™ and UFMPLUS™ Tray high performance trays

2000

2010

VGPLUS™ and VG AF™ high performance trays

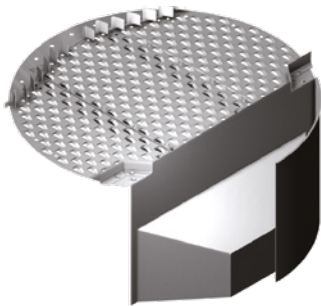

In 2000, Sulzer introduced high performance VGPlus trays which provide higher capacity with the combination of enhanced downcomers and optimized tray layout.

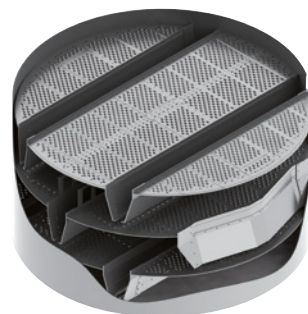

Sulzer has also introduced high performance VG AF™ anti-fouling trays, part of VGPlus tray family, featuring large fixed and push valves, and fouling resistant outlet weirs.

6-pass high performance trays

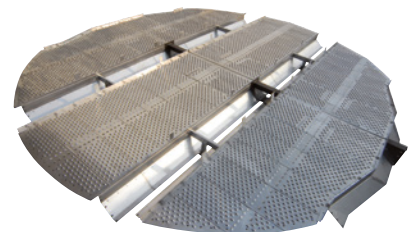

Sulzer's 6-pass VGPlus high performance trays were successfully installed in several C3 Splitters and are performing beyond expectations.

6-pass trays are a natural progression after 4-pass trays for large diameter columns (typically > 6 m) with high liquid loads.

UFMPlus™ and VGPlus™

UFMPlus and VGPlus, are Sulzer's high performance chordal downcomer trays. They offer industry proven and validated advanced tray technology for today's market.

Enhanced downcomers

A main feature of Sulzer UFMPlus and VGPlus trays is the use of high performance downcomers such as highly sloped, Truncated, StepArc (stepped), ModArc and our latest Prism downcomers. These downcomer designs maximize the tray deck area by optimizing the downcomer bottom area, thereby increasing vapor handling capacity and reducing pressure drop and backup.

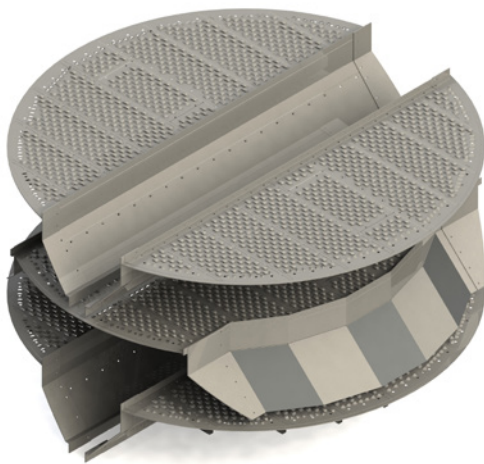

2-pass UFMPlus tray equipped with Prism downcomers, UFM and push valves.

Enhanced decks

Sulzer high capacity trays can be equipped with high capacity fixed valves or float valves. UFMPlus trays use high capacity UFM float valves while VGPlus trays are equipped with high capacity fixed valves such as MVG or MMVG.

Redirecting and froth promoting devices such as push valves and baffle bars, enhance the vapor/ liquid interaction on the tray deck.

Liquid flow study of conventional trays

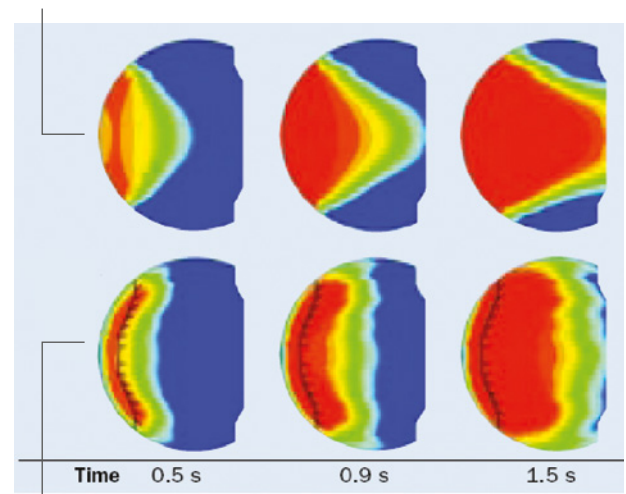

Liquid flow study of VGPlus with baffle bars

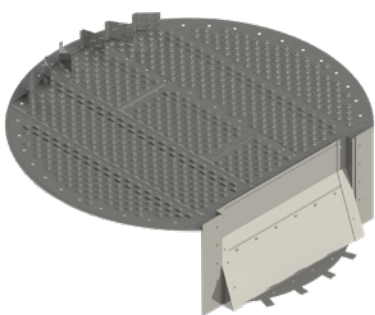

Truncated downcomer

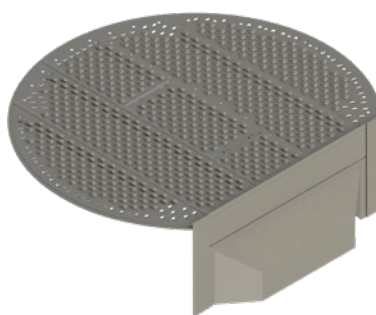

StepArc™ downcomer

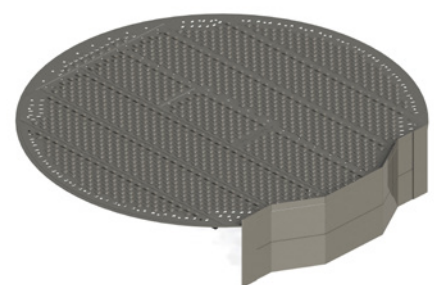

ModArc™ downcomer

UFMPlus™ trays

UFMPlus trays are enhanced downcomer trays with high capacity UFM float valves and innovative periphery valves which further boost the performance of the trays.

UFM valves are an advanced type of movable mini-valve which maximize the hydraulic capacity, the separation efficiency, and the operating range of fractionation trays.

The “Umbrella” shape of UFM valves reduces the jetting momentum of the released vapor which maximizes the contact area of vapor and liquid on the tray deck and promotes uniform mixing and minimizes entrainment.

The UFM tray deck offers better turndown capability than a fixed valve tray, i.e. up to 5:1.

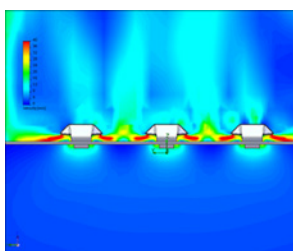

VGPlus™ tray

VGPlus trays are enhanced downcomer trays with high capacity MVG or MMVG fixed valves.

MVG valves provide higher capacity compared to standard sieve or conventional valves, while providing higher efficiency and lower pressure drop per theoretical stage. The MVG tray deck offers better turndown capability than a sieve tray, i.e. up to 3:1.

MMVG valves are used where extremely high vapor capacity or a very low pressure drop is required. The smaller size opening compared to MVG results in up to 7% additional capacity.

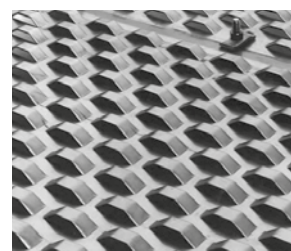
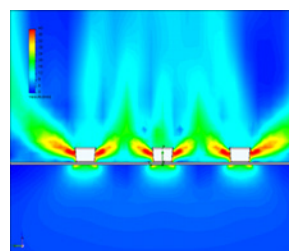

FRI Validation

Sulzer UFM valves have been tested at FRI, in the cyclohexane/n-hexane system at 1.6 bar and in the ortho-xylene/para-xylene system at 1.0 bar. The UFM valves showed a 30% increase in efficient capacity when compared to conventional valves, making the UFM tray one of the highest capacity trays ever tested at FRI, at these conditions.

FRI Validation

Sulzer VGPlus trays have been tested at FRI, in the isobutane/n-butane system at 7 and 11 bar. The VGPlus tray is one of the best performing trays ever tested, delivering up to 10% higher capacity than some other tested competitor's high performance trays.

Key Areas of Application

- Refinery: Main Fractionators and Gas Plants
- Olefins: Deethanizers, Depropanizers, Debutanizers, Deisobutanizers, SuperFractionators: C2 and C3 Splitters
- Aromatics: Xylene Splitters, Xylene Rerun, Raffinate Columns

Sulzer “Plus” technology

Case study - Revamp of deisobutanizer with VGPlus™ trays

A refinery deisobutanizer column, upstream of an HF alkylation unit, was identified to be the bottleneck of the capacity expansion.

This deisobutanizer column of ID 2.96 m was originally equipped with 56 2-pass conventional round valve trays. A process study highlighted that the throughput could be almost doubled by retrofitting the tower with high performance trays.

Revamp objective:

- Maximize the production of iC4
- Minimize nC4 in top product: <3 wt%
- Maximize iC4 recovery: >94 wt%

Revamp solution:

Sulzer VGPlus high performance trays with

- MVG fixed valves
- ModArc side downcomers
- Froth enhancers: push valves

Test run was performed at 143% of the pre-revamp capacity due to shortage of feedstock. To further load the tower, the reflux ratio was increased till maximum reboiler duty: the production of iC4 increased by 57%, with a nC4 impurity as low as 0.9 wt% and iC4 recovery over 98 wt% leading to a tray efficiency over 93% even at flooding close to 90%.

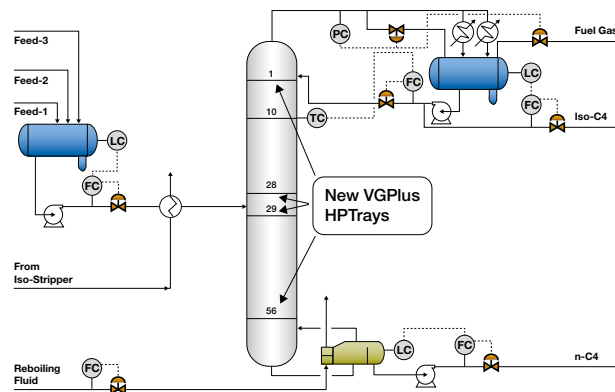

	Before revamp	Test run
Feed flow rate	100%	143%
Top iC4 flow rate	100%	157%
Reflux ratio	NA	17.5
Tray efficiency	NA	> 93%
nC4 impurity	> 3 wt%	< 0.9 wt%
iC4 recovery	< 94 wt%	> 98 wt%
Flooding	NA	89%

Sulzer's experience - 6-pass VGPlus™ trays for new C3 splitters

Three new C3 Splitters, each designed with 195 6-pass VGPlus high performance trays.

For columns with large diameters, 6-pass trays provide extensive weir length to handle the high liquid loads. The multiple pass design also avoids excessively long flow path lengths to mitigate undesirable liquid flow gradients on the tray decks. Enhanced downcomers are utilized to maximize the bubbling area for mass transfer.



Sulzer design:

Sulzer VGPlus high performance trays with

- MVG fixed valves
- ModArc side downcomers
- Froth enhancers: push valves

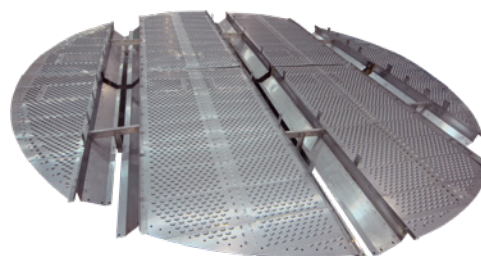

Anti-fouling trays

UFM™ AF

UFM AF is the latest addition to our fixed valve portfolio. This enhanced valve is part of the UFMPPlus tray family, developed for fouling service.

UFM AF is a large size valve which provides excellent fouling resistance, especially when designed with the following anti-fouling features on the tray:

- Modified outlet weirs: stepped or sloped
- Push valves

UFM AF is a premium anti-fouling valve with very high efficient capacity. Enhanced downcomers can be applied to UFM AF trays for even higher capacity, if required.

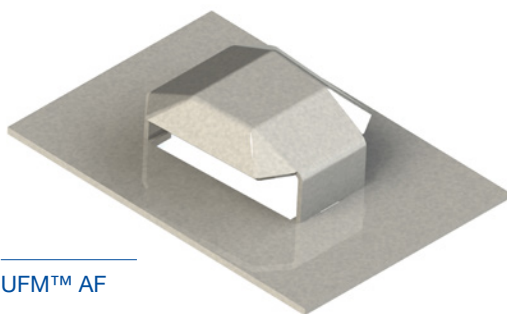

UFM™ AF

VG AF™

VG AF (anti-fouling) trays are part of the VGPlus tray family and especially designed for fouling services. Tray decks of VG AF will either be with SVG, our standard-fouling valve, or XVG, our extra large V-Grid developed especially for severe fouling services. Other anti-fouling tray design features like enhanced outlet weirs and push valves will also be applied.



2-pass VG AF trays with V-Grid, sloped outlet weir and push valves.

Key Areas of Application

- Primary fractionators in ethylene plant
- Stripping section of CDU and VDU
- Coker main fractionators
- Heads and dry columns of acrylonitrile plant
- PVC slurry strippers
- Beer columns

Case study - Revamp of acrylonitrile heads and dry column to VG AF™

Acrylonitrile (ACN) heads and dry column was revamped from round valves trays to Sulzer VG AF anti-fouling trays for higher performance and longer run length. This ACN column was originally equipped with 62 1-pass conventional round valve trays.

Revamp objective:

- Increase capacity by 25%
- Maximize acrylonitrile recovery: > 91 wt%
- Maximize run length: > 6 months

Revamp solution:

- Sulzer VG AF anti-fouling trays with
- SVG fixed valves
- Stepped outlet weirs
- Froth enhancers: push valves

As a result of the revamp with VG AF trays, the column capacity increased by 25%. The ACN recovery improved to 95% and the run length increased to more than 11 months.

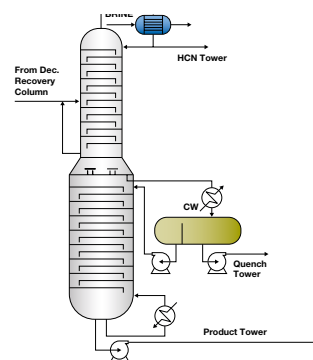

	Before revamp	After revamp
Feed	100%	125%
ACN production	100%	130%
ACN recovery	91 wt%	95 wt%
Tray efficiency	70%	74%
Run length [months]	4	>11

Shell high performance trays

Shell HiFi Plus trays

Shell HiFi trays are fractionation trays equipped with multiple envelope downcomers, oriented offset to the tray's center line.

They are supported on a 360° support ring and central major beams, without the need of the downcomer bolting bars.

For a given column diameter, they allow for:

- Highest number of passes
- Large downcomer area
- Long weir length
- High hydraulic capacity
- Low tray spacing
- High NTS per column height

The HiFi Plus trays are an enhanced version featuring advanced valves (i.e. MVG, MMVG, UFM) to further boost the tray deck performance, and/or the Crown Inlet Device CID™ to maximize the downcomer capacity as well.

FRI Validation

Shell HiFi trays, with tray spacings of 305 mm and 610 mm, have been tested at FRI, in the iso-butane/n-butane system at 11, 21 and 28 bar. As compared to 1-pass round valve trays with truncated downcomers, Shell HiFi trays of same tray spacing, exhibit up to 40% higher capacity.

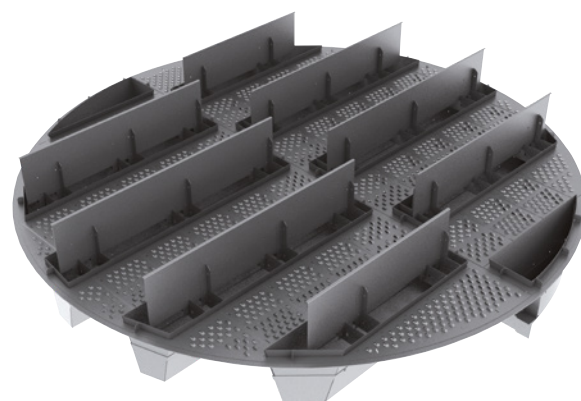

HiFi Plus tray with MVG™ valves

Key Areas of Application

- Refinery: Main fractionators' PA and stripping sections
- Olefins: Deethanizers, Depropanizers, Debutanizers, Deisobutanizers, SuperFractionators: C2 and C3 Splitters
- Aromatics: Xylene Splitters, Xylene Rerun, Raffinate Columns
- Gas Sweetening: absorbers, regenerators

Sulzer's experience - New Shell HiFi trays for crude distillation

Revamp of top 3 pumparound trays of a crude distillation column from conventional trays to Shell HiFi trays which offer longer weir length to handle the higher liquid loads. Due to large column diameter of 9.6 m, two beams were required for each tray.

Revamp design:

Shell HiFi trays with 2 beams design

- 21 HiFi downcomer boxes
- Long weir length > 110 m.



Case study - Revamp of C2 Splitter to Shell HiFi Plus trays

A C2 Splitter (3.96 m I.D.), was revamped from 153 competitor's Multi-Downcomer trays to 123 Shell HiFi trays for improved C2 Splitter performance – higher capacity and stringent product purity.

Revamp objective:

- Increase capacity by 25%
- Ethylene purity: 99.96 wt%

Revamp solution:

Shell HiFi Plus trays with

- MMVG fixed valves
- HiFi downcomer boxes
- Long weir length > 23 m

During the performance test run when the column was artificially loaded up for the highest throughput, steady operation was observed with a useful capacity around 95%, and a measured ethylene purity of 99.98%. A tray efficiency of 79% was achieved.

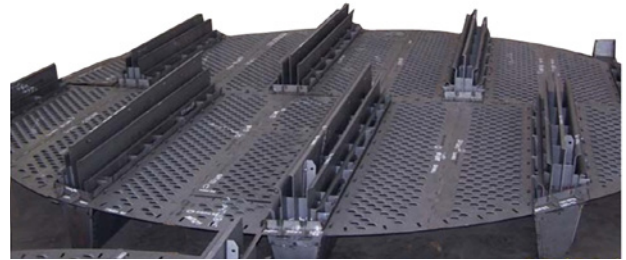

Full assembly during trial layout at workshop

	Design	Test run
Ethylene purity	99.96%	99.98%
Tray efficiency	80%	79%

Case study - New xylene rerun column with Shell HiFi Plus trays

A new xylene rerun column, of ID 8.3 m and 8.6 m, was designed with 117 Shell Plus Trays. The design included 1 lattice beam for every 2 trays.

Process requirements:

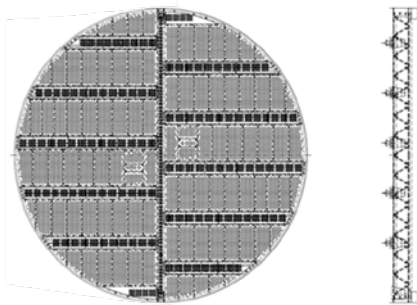

- C9+ impurity in distillate: <300 ppmwt
- o-xylene recovery in distillate: >99.0 wt%

Sulzer design:

Shell HiFi Plus trays with

- MVG fixed valves
- 10 and 12 HiFi downcomer boxes
- Long weir length > 60 m

Although actual production was less than maximum loads, the reflux ratio was higher than design due to higher amount of impurities in feed. The Shell HiFi Plus trays performed well, providing high capacity while meeting the process requirements.

This column was compared with a similar column in client's plant, equipped with competitor's multi-downcomer trays, and proved to be better in terms of relative energy consumption and product recovery.

	Design	Actual operation
C9+ impurity in distillate	<300 ppm	200 ppm
o-xylene recovery in distillate	99.0%	99.5%
Tray efficiency	73%	74%

Shell ultra-system limit High performance trays

Shell ConSep Plus trays

The Shell ConSep Plus trays are one of the highest capacity fractionation trays available on the market, offering up to 80% additional capacity over conventional trays without any major impact on separation efficiency.

They utilize the principle of de-entrainment by centrifugal force to overcome the gravitational limitation of jet flooding, and the system limit of the vessel.

Every set of ConSep Plus tray consists of a primary tray (with chordal or HiFi downcomer layout) and a secondary tray with Swirl tubes.

FRI Validation

Shell first generation ConSep Plus trays had been tested at FRI, in iso-butane/n-butane system at 11 bar. At least 50% higher capacity was observed over some other high performance trays, with a separation efficiency as high as 90% and capacity substantially exceeding the system limit of the column.

The new generation ConSep Plus trays exceeds capacity and efficiency of first generation ConSep trays with the following advantages:

- **Higher capacity:** Achieve up to 30% more capacity than first generation ConSep trays, depending on pressure and liquid load
- **Enhanced efficiency:** Benefit from 5-10% improved efficiency
- **Wide operating range:** Improved turn-down (1:5) capabilities subject to valve selection
- **Exceptional performance at High-Pressure applications** (e.g. deethanizer): Up to 50% more capacity compared to other high performance trays



Shell ConSep Plus trays with UFM vales

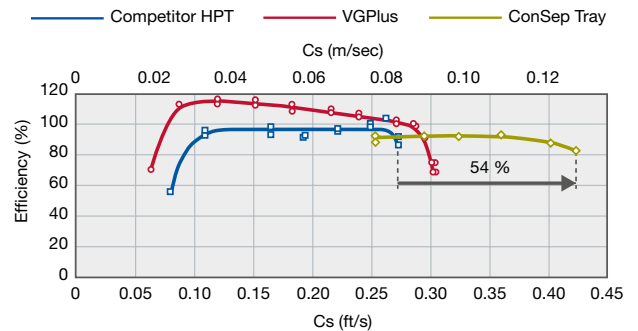

Test mixture: iC4 / nC4 @ 11 bara (Shell Facility)

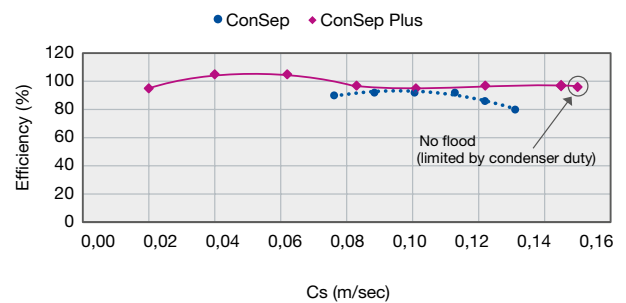

Cs: = Capacity factor based on column cross-sectional area

Experience list of Shell ConSep trays:

Key Areas of Application

- Refinery: Main fractionators
- Olefins: Deethanizers, Depropanizers, Debutanizers, Superfractionators C2 and C3 Splitters

Service	Industry	No. of columns
Debutanizer	Refinery	7
Depropanizer	Refinery	5
Main fractionator	Refinery	4
Naphtha splitter	Refinery	2
Diesel HDT stripper	Refinery	3
H2S stripper	Refinery	1
C2 splitter	Olefins	1
PO drying column	Chemicals	1
C6 dryer	Chemicals	1
Reformate Splitter	Refinery	1
C2 Green Oil Scrubber	Olefins	1

As of December 2023

Case study - From first generation ConSep to ConSep Plus: A Case study of HCU fractionator revamp

The Hydrocracker in Europe was commissioned in 1982 and has been revamped several times. In 1999, the main fractionator was revamped from 41 nos. of Shell HiFi trays to same numbers of Shell first generation ConSep trays which can handle increased capacity by almost 50% from original design. These ConSep trays were revamped in 2019 to Shell new generation ConSep Plus trays for another 25-30% increase in capacity.

Revamp objective:

Conversion of the hydrocracker was to be increased from 60% to 90%, which increased load on the fractionator, particularly the top section. The TCR (top circulating reflux) section of the fractionator was limiting in capacity by 25-30%.

Revamp solution:

The TCR section had first generation ConSep trays which were revamped with ConSep Plus trays.

The column was started up in 2019, it achieved the desired capacity for the revamp with no tray hydraulic constraints or product quality issues were experienced.

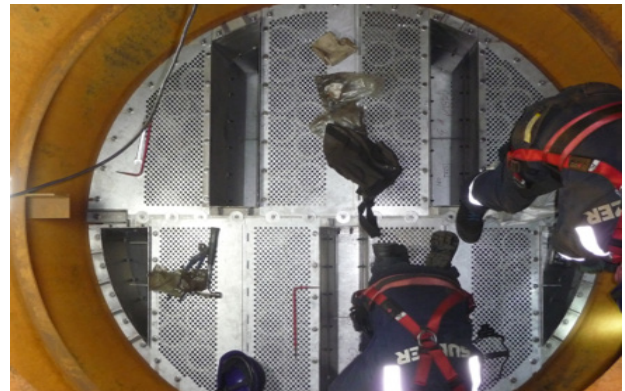

Mechanical features

Non-welded tray support system

In several revamp projects aimed to increase the separation stages of an existing column, the number of actual trays had to increase (e.g. 3-for-2, 4-for-3, or 5-for-4).

To accomplish this, a mechanical design is required to avoid impact on the schedule of the plant's turn-around, and minimize cost as well.

Sulzer has developed a mechanical solution enabling installation of the trays by reusing the existing tower attachments, without any direct welding to the tower wall, thus avoiding any post-welding heat treatment and/or hydraulic testing of the vessel. This technique consistently reduce the turnaround time by using this technique.

The following devices show in the illustration below are used:

- Expansion rings
- Expansion joints
- Vertical struts
- Downcomer adaptors
- Solid or lattice beams

The system can be also used for other purposes: modify the geometry of existing downcomers, modify the number of passes; change the tray orientation; replace packing beds with trays.

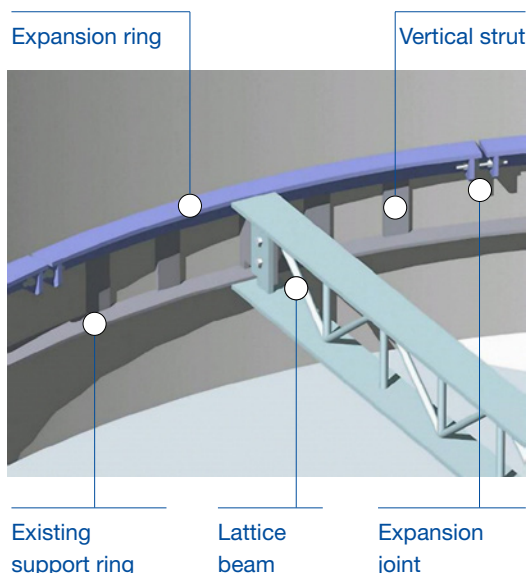

Trays for heavy duty services

In some applications, particularly those subjected to operating upsets leading to panel dislodgment, the trays must withstand higher than normal mechanical loadings, i.e. 7000 N / m² (1 psi) or even 14000 N / m² (2 psi).

In such cases, special features may be employed in the mechanical design:

- Through-bolting panel connection
- Shear clips
- Downcomer spreaders
- Explosion doors



2 psi uplift BDH™ tray equipped with through-bolting assembly, shear clips and explosion doors.

Lip-Slot™ panel connection

The Lip-Slot is an enhanced type of tray panel connection which allows for:

- safe and easy installation
- up to 30% less installation time
- less maintenance costs as it does not use any bolted connection
- same mechanical reliability as conventional connections

The Lip-Slot is combined with universal clamps for the fixation around the tray periphery.

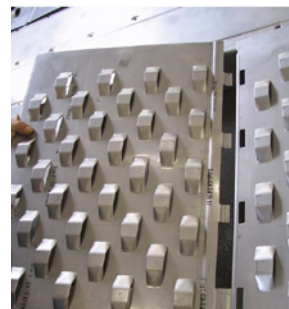

Services

Computer-aided engineering (CAE): 3D models

Upfront engineering and design play a crucial role in cost optimization. Sulzer has integrated all major mass transfer products into an in-house design tool, creating a global standard.

Customers profit directly from the use of our internal CAE tool. Layout drawings supplied in the course of the engineering phase will show a 3D sketch of the equipment being designed, for an easy and fast checking by the customer.



Natural frequency analysis for tray vibration phenomena

In some critical applications and under specific operating conditions, vibration phenomena may be induced to the trays. Based on plant feed-back data and in-house know-how, Sulzer has developed a design tool to check for the following two main parameters:

- Natural frequency of the tray panels, as a function of the geometry, the supports, and the material of construction.
- Vibration factor, as a function of the flow rates and physical properties of the streams being processed.

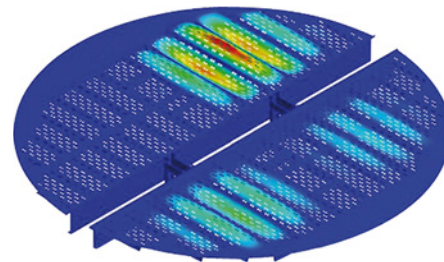

Natural frequency analysis of a full tray

Finite elements method (FEM) and computational fluid dynamics (CFD)

Sulzer also employs other advanced design tools, for example verification of mechanical integrity and functionality using finite element and CFD analysis.

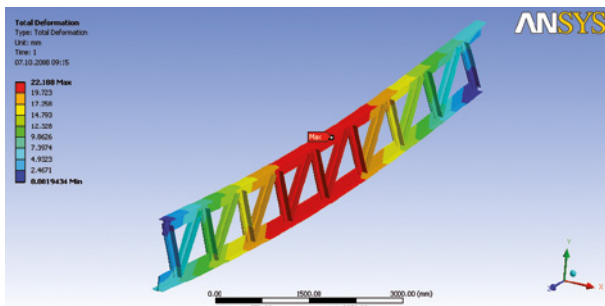

Turn around and tower field services

Sulzer's global manufacturing capabilities ensure fast delivery of any tray hardware and replacement tray parts, regardless of original supplier. These can be manufactured from existing drawings or damaged parts and supplied on site quickly to meet your turnaround schedules. Replacement hardware can be supplied on consignment in lockers or trailers for convenience.



The Chemtech division is the global market leader in innovative mass transfer, static mixing and polymer solutions for petrochemicals, refining and LNG.

Chemtech is also leading the way in ecological solutions such as biopolymers as well as textile and plastic recycling, contributing to a circular economy. Our product offering ranges from technology licensing to process components all the way to complete separation process plants. Customer support ranges from engineering and field services to tray and packing installation, tower maintenance, welding and plant turnaround projects – ensuring minimal downtime.

E10504 en 2.2025, Copyright © Sulzer Ltd 2025

This brochure is a general presentation. It does not provide any warranty or guarantee of any kind. Please, contact us for a description of the warranties and guarantees offered with our products. Directions for use and safety will be given separately. All information herein is subject to change without notice.

