

MC[®] equipment in pulp and paper mill applications



1. MCE™ pump – New performance in the pumping and transfer of medium consistency (MC[®]) stock

1.1. Introduction

The first commercial fluidizing centrifugal MC pump with degassing started in a chemical pulp bleaching application in 1980. During the years, MC pumping development has introduced the second generation and now the 3rd generation MCE pumping system products have been introduced with

- larger capacity ranges (Fig.1c, Fig. 4)
- lower energy consumption (Fig.1a)
- higher pump heads (Fig.1b, Fig. 4)
- higher pumping consistencies and temperatures

Besides MC pumping, there are number of other process equipment and solutions where the principles of MC technology have been applied (Fig. 2). These include SX chemical mixers for mixing both gaseous and liquid bleaching chemicals and also steam into the pulp, the MC discharge scraper for discharging high consistency towers and the fluidizing MC discharger for effective flow splitting and upflow tower feed and discharge.

Efficient ‘in-line’ dilution systems for diluting the MC pulp with the static dilution mixer into lower consistency enables to improve the existing applications.

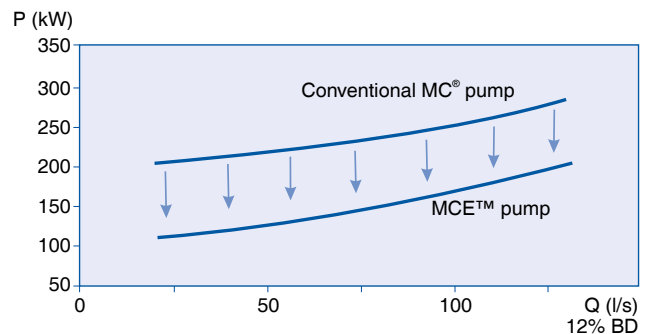

Fig. 1a. Power consumption savings.

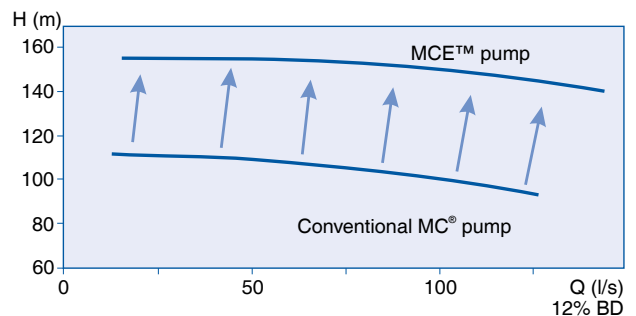

Fig. 1b. Higher pump heads with existing power consumption.

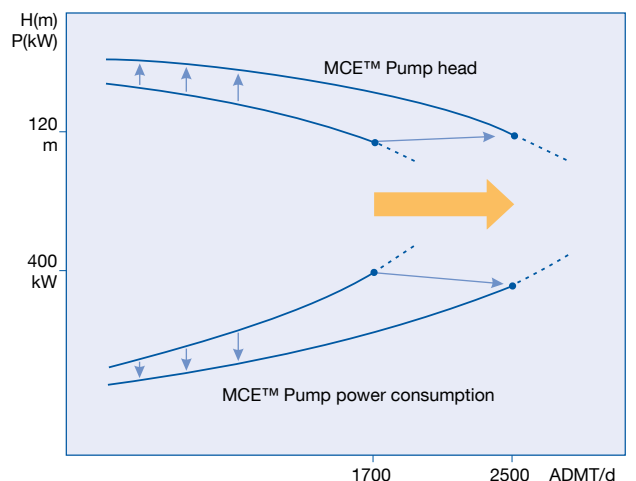

Fig. 1c. Production rate increase from 1,700 to 2,500 ADMT/d without increasing the power consumption.



Fig. 2. MC equipment applications in a modern bleaching plant.

1.2. MCE pump – effective hydraulic performance together with reliable and sturdy mechanical designs is a new standard to meet mill scale requirements in MC pumping

A new level of performance over a wide consistency, temperature and pressure range is provided by the unique patented Fluider™ impeller having effective multifunctional turbulence generation, gas separation, pumping hydraulics and degassing combined with a wide passage gas removal system of high capacity (Fig. 3).

1.3. MCE pump series as alternative designs

Sulzer presents the new MCE pump products. These guarantee that the ideal high performance pump is available for the prevailing pumping conditions and applications, also giving optimum reliability and interchangeability with the existing pumps.

The MCE pump is provided with a separate external MDS degassing system or with a built-in degassing system. Both alternatives incorporate the same benefits of Sulzer’s third generation centrifugal MC pumps. The new MC technology is providing several MC applications to be arranged without any degassing pumps installed. The MCE pump series (Fig.4) covers capacity ranges of 20 to 9000 ADMT/d and pump heads up to 240 meters. Stainless steel material alternatives for these pumps are duplex steels like A-890 grades 3A and 5A. 654SMO or titanium can be selected as the best corrosion resistant material for the wetted parts of the pump (Fig. 5).

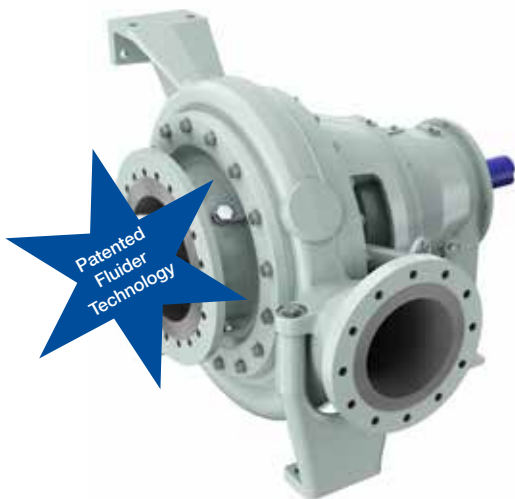

Fig. 3. MCE pump arrangement for the 8 to 18% consistency range.

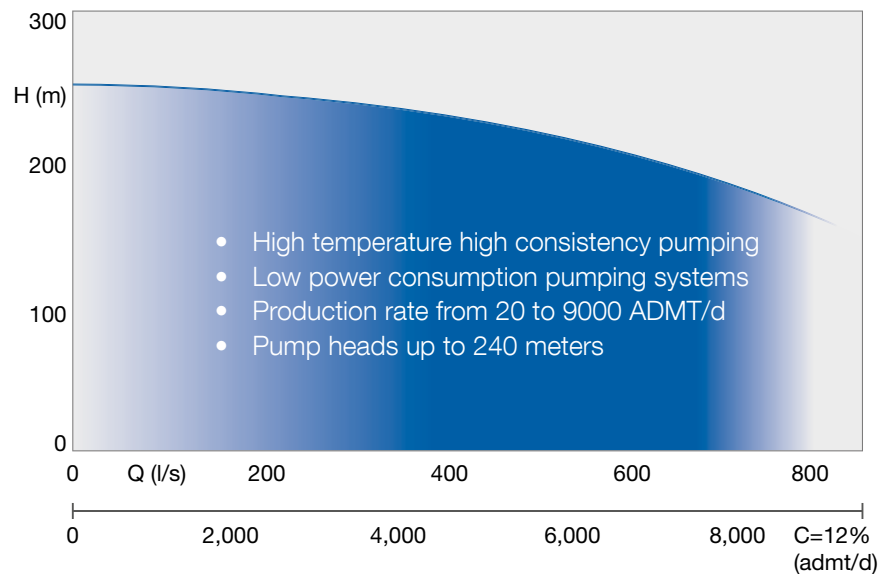

Fig. 4. MCE pump series capacity range.

Grade	Nominal chemical composition %					
	C	Cr	Ni	Mo	Cu	N
Duplex steels (austenitic-ferritic, solution heat treated)						
A-890 Grade 3A	max. 0.06	24.0-27.0	4.0-6.0	1.75-2.50		0.15-0.25
A-890 Grade 5A	max. 0.03	24.0-26.0	6.0-8.0	4.0-5.0		0.10-0.30
Austenitic cast steels (solution heat treated)						
AVESTA 654SMO*	max. 0.025	23.0-25.0	21.0-23.0	7.1-7.5	0.3-0.7	0.40-0.55

* AVESTA 654SMO is a trademark owned by Outokumpu Stainless which has granted Sulzer license to produce this material.

Fig. 5. Corrosion resistant cast steel material examples for MC equipment.

1.4. MCE pumping application examples

1.4.1. High temperature high consistency pumping from a low level pumping vessel

The most common application of MC pumping is to pump stock from washers and thickeners. The stock falls into the MDL dropleg and is then transferred to the subsequent process stage by the MCE pump. MC pumping is controlled so that all the stock falling into the dropleg can be pumped further at the highest possible consistency and temperature. As an example: with the new MCE pump innovations, stock with a consistency of 14-16% and temperature of +95°C can now be pumped from a low level pumping vessel. This is a significant process saving (as steam costs) and layout advantage e.g. in O2 delignification, EOP and PO stages (Fig.6).

The stock level in the MDL dropleg is measured by means of a gamma ray, capacitive measurement or pressure transmitter.

The flow rate through the pump can be adjusted, depending on the circumstances, by means of a control valve, by changing the speed of the pump, or by applying a combination of these two methods (Fig. 7). The level controller keeps the stock level in the dropleg constant, not allowing the level to drop nor allowing the level to enter the previous equipment such as the washer; thus providing stable operation in the process. The separate or built-in degassing system adapts itself to the respective volume of air contained in the stock and to the flow rate used (Fig. 8). If great consistency variations occur in the incoming stock, caused by a disturbance at the thickener or washer, the automatic dilution system will stabilize pumping.

1.4.2. Bleaching stages reaching higher performance and chemical savings

The same MCE high performance has also been used for capacity and process upgrades through the installation of an MCE retrofit (Fig. 9) to the existing MC pumps of earlier generations. The same improvement can be realized through the installation of an MCA/MCV hydrofit to the existing MCA/MCV pumps. These result in an improved process economy and increased production rate.

The retrofits and hydrofits have been possible with only minor bare pump mechanical modifications, often requiring no piping or drive changes.

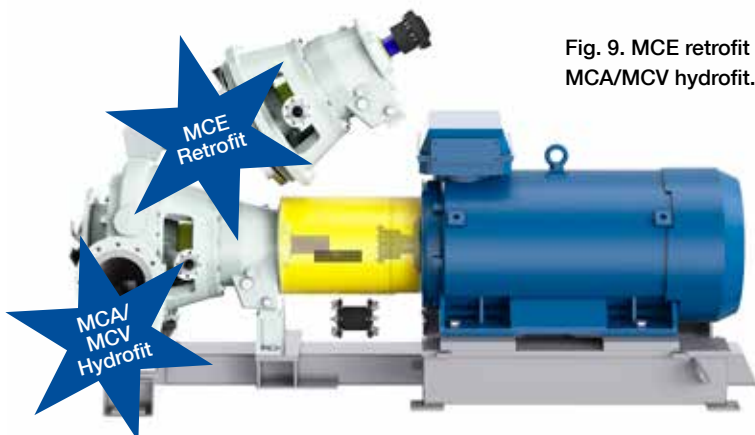

Fig. 9. MCE retrofit and MCA/MCV hydrofit.

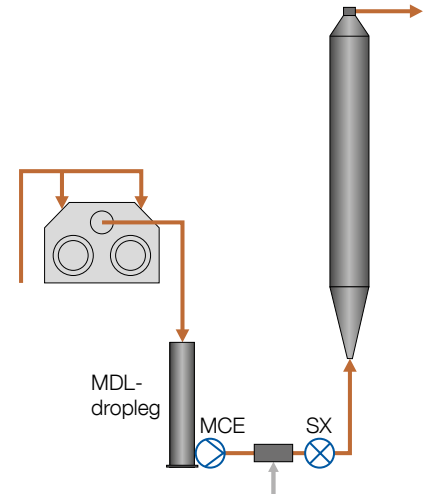

Fig. 6. Pumping from washers and thickeners.

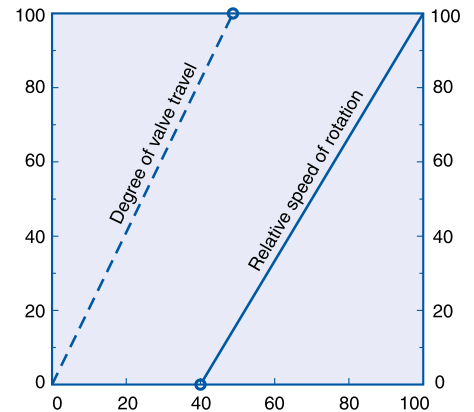

Fig. 7. Combined valve and speed control system.

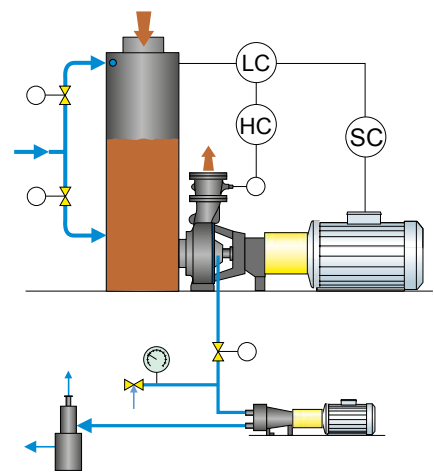

Fig. 8. Control system in MC dropleg installation.

1.4.3. Flow splitting after discharge from the MC pump

The flow divider, a “static” flow distributor, is used to divide the stock flow from the MC pump to two or three different directions. The flow divider is connected directly to the discharge flange of the MC pump (Fig. 10). The flow divider has a welded, specially shaped sturdy construction, and the standard materials are EN1.4404 stainless steel, 254SMO or titanium depending on the process requirements. This application is often used in pulp mill processes when creating an option to bypass a bleaching stage and when one pump is feeding two washers (Fig. 11) or two or three storage towers. This parallel pipeline idea is typically advisable from the point of view of layout and costs, if the washers or towers are not located far from the pumping system.

1.4.4. Booster pumping to feed pressurized bleaching reactors

In the modern pressurized bleaching stages (oxygen delignification and PO stages), it is necessary to create very high stock line pressures with the MC pump feeding the stage so that the required process pressures can be achieved in the reactors. In these process applications, steam is fed and mixed into the pulp suspension to reach the process temperature, and chemicals such as oxygen are also fed and mixed into the stock in the pressurized pipeline.

It is possible that the head requirement of the MC pump results in such a high stock line pressure that the available steam or oxygen pressures are not high enough to enable steam/oxygen feed and control. In these cases it is necessary to find a way to reduce the stock line pressure in locations where steam and chemicals are fed. The solution is to install another MC pump, a booster pump, in the stock line and thus divide the head generation between two MC pumps. The advisable location of the booster MC pump depends on the detailed process data and on the mill arrangements (Fig. 12).

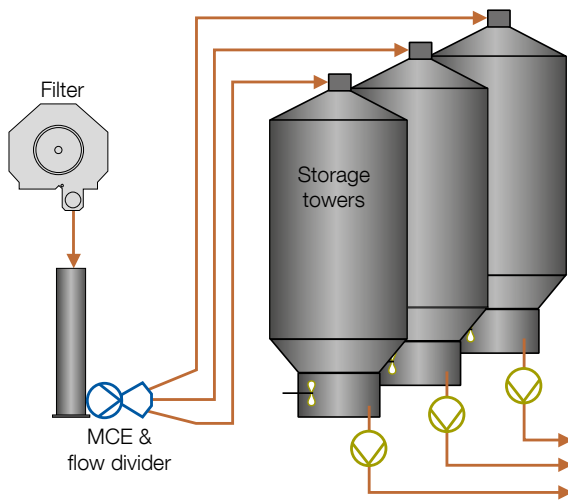

Fig. 10. MC flow divider feeding storage towers.

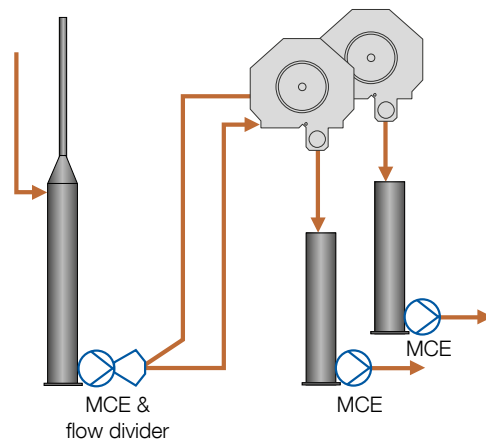

Fig. 11. MC flow divider feeding two washers.

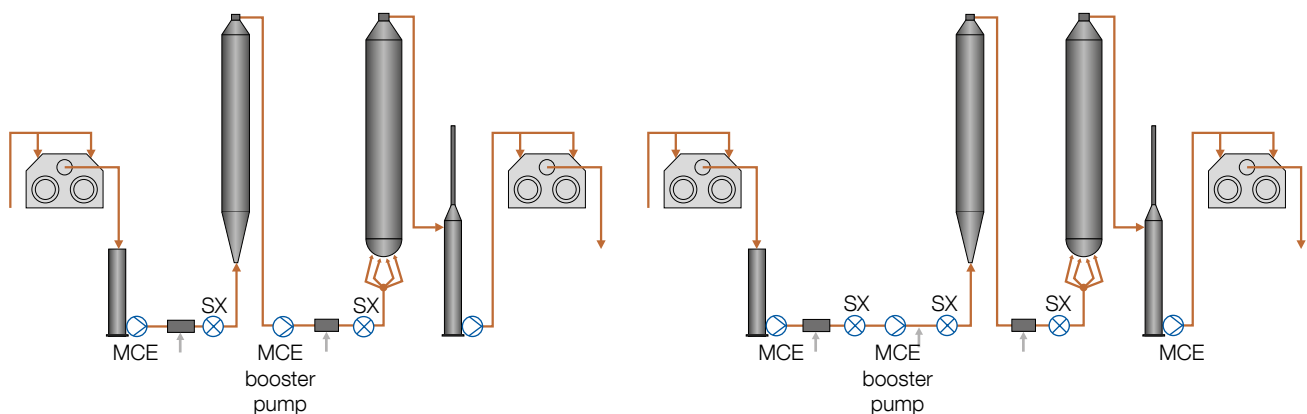

Fig. 12. MC booster pumps for feeding pressurized bleaching reactors.

1.4.5. Tower discharge pumping

The discharge of large high consistency storage or bleaching towers is often difficult, especially when a well-controlled stock flow to a bleaching stage or to the washer is required (Fig. 13). The MC tower discharge pumping system consists of the following key components: MC discharge scraper, MTB feed chute, tower isolation valve, MCE pump and MDS degassing system (Fig. 14). The MC discharge scraper manufactured by Sulzer operates in connection with a medium consistency tower discharge pump. The scraper scrapes the stock over the complete bottom area of the tower and leads it into the feed chute of the MCE pump, thus enabling an even discharge and simultaneously preventing channelling of the stock in the tower.

The MC discharge scraper also stabilizes the pumping procedure. The discharge scraper is available as a diluting or non-diluting model. The diluting scraper simultaneously dilutes the stock uniformly and discharges the tower without interference. When using diluting scrapers, the consistency of the stock in the tower can be high (20 to 35%), and the pumping consistency is then within the MC range.

MC discharge scrapers are manufactured in different sizes up to a diameter of 6,500 mm. Each scraper size is available with or without the possibility for dilution. The smallest scraper sizes with a planetary gear are suspended from the tower bottom while the bigger sizes are provided with a spur gear which is fixed to the floor under the tower (Fig. 15). These constructions do not require any separate additional bearing units.

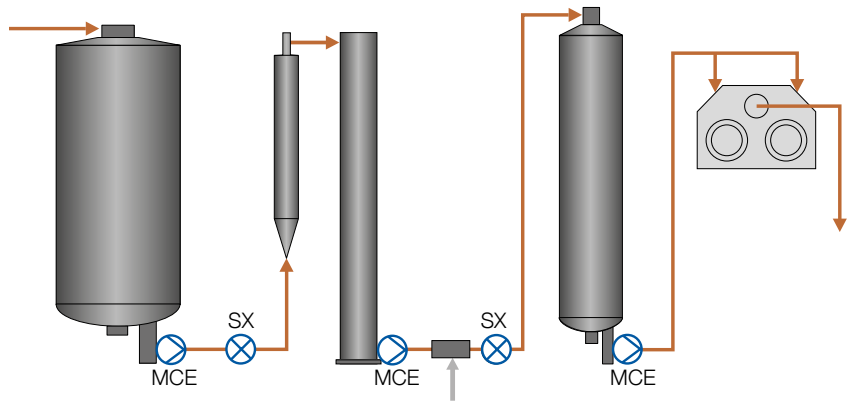

Fig. 13. Typical tower discharge MC pumping systems.

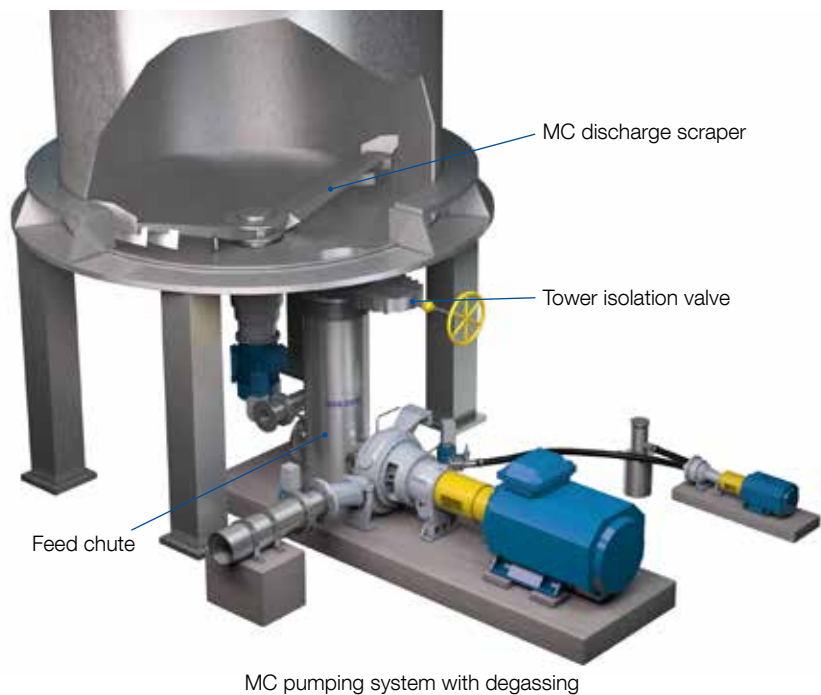

Fig. 14. MC pumping system components in a tower discharge pumping system.

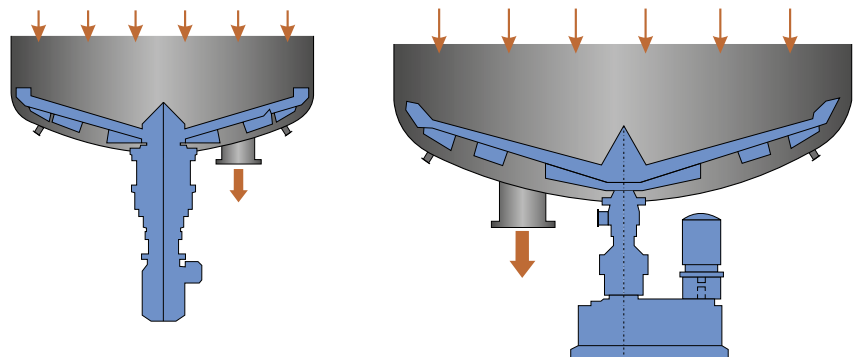

Fig. 15. MC discharge scraper constructions.

The MC discharge scraper material alternatives are EN1.4404 stainless steel, 254SMO or corrosion resistant duplex steels.

The MC tower discharge pumping system can have different control strategies:

- The flow controller (FC) controls the flow rate of the MC pump by the valve (Fig. 16), variable speed of the pump, or by a combination of these methods.
- The level controller keeps the level in the tower constant by using the discharge control valve and/or pump speed for control or,
- Flow control and level control are used at the same time so that the flow rate is kept constant and the flow rate set point is changed only if the level in the tower tends to change beyond the level set points.

Gas/air is removed by having a degassing system in combination with the MC pump (Fig. 17). Stock can be diluted to the process consistency with the tower bottom water connections, with a diluting MC discharge scraper, and also in the MTB feed chute (Fig. 17).

1.4.6. Booster pumping in long distance stock transfer applications

In an integrated pulp and paper mill, the distance between the pulp mill and the paper mill is often in the range of 300 to 400 meters. Stock is generally pumped in a diluted form, but an MC pump enables pumping at a consistency of 10 to 12%. Medium consistency stock enters the dropleg of the MCE pump from the filter. The MCE pump, which is provided with degassing and rotates at a fixed or variable speed, pumps the stock to a booster pump of the same size where no degassing is required. The booster pump, which is provided with variable speed control pumps the stock to a storage tower (Fig. 18).

1.4.7. Pumping and controlled flow splitting to storage towers or to intermediate mixing chests with an MC pump and a MC discharger

It is often necessary to transfer bleached stock from the pulp mill to several storage towers which are all located relatively far (50 to 400 meters) from the bleached stock washer and thus also far from the corresponding MCE pump (Fig. 19). This application is carried out so that there is only one discharge pipeline from the MCE pump to the area of the storage towers, and the flow is then divided at the end of the pipeline to several flows, directed to the towers.

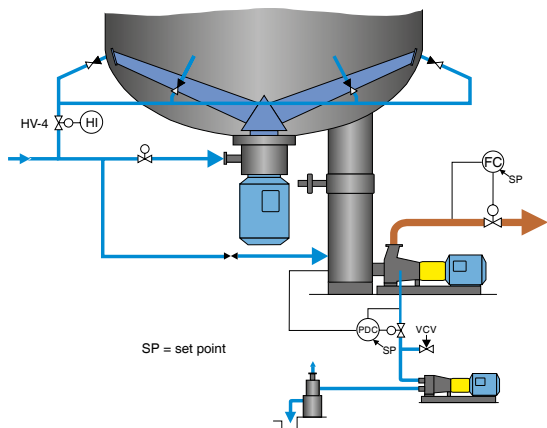

Fig. 16. Control system in MC tower discharge installation.



Fig. 17. MC tower discharge pumping system.

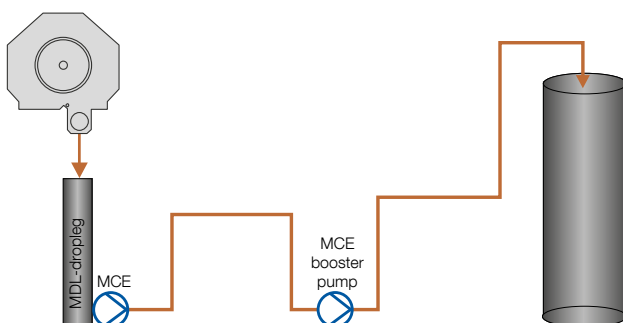

Fig. 18. MC booster pumping process application.

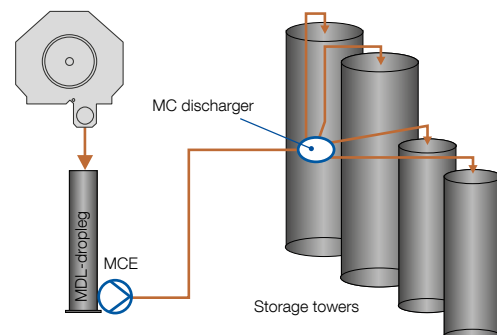

Fig. 19. MC discharger in storage tower application.

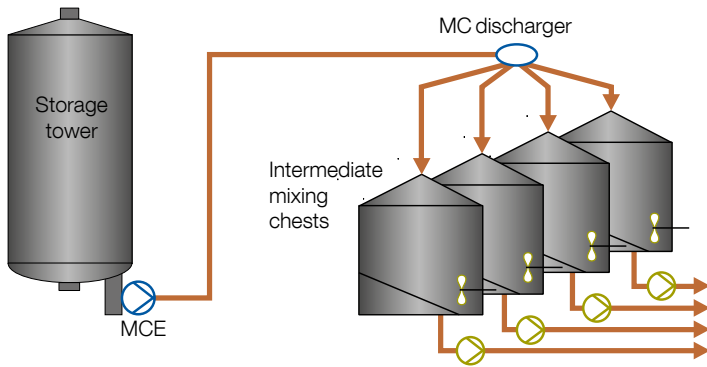

Fig. 20. MC discharger feeding a number of intermediate mixing chests.



Fig. 23. MC parallel pumping system arrangement.

The same type of application is also useful near the paper machines, when the stock has to be distributed into several intermediate mixing chests. The storage tower feed to the tanks is equipped with MC discharger. The MC discharger is used to split the flow in equal proportions to the intermediate mixing chests (Fig. 20)

A plug flow is generated in the pipe when pumping medium consistency (8 to 18%) stock, and the fiber network holds the plug together. Dividing this kind of flow to precisely controlled partial flows at the end of a pipeline is not possible with only a valve; an MC discharger is used in this application to fluidize the stock and to divide and control the partial flows to the towers.

The MC discharger operates so that the stock entering the chamber of the discharger is fluidized by a rotor, and the outlet flanges are directly connected to this same chamber. Depending on the application, up to four outlet connections are available in one discharger, all connections with control or on/off valves (Fig. 21). The MC discharger itself does not generate pressure, so an MC pump is required in the process to pump the stock through the discharger.

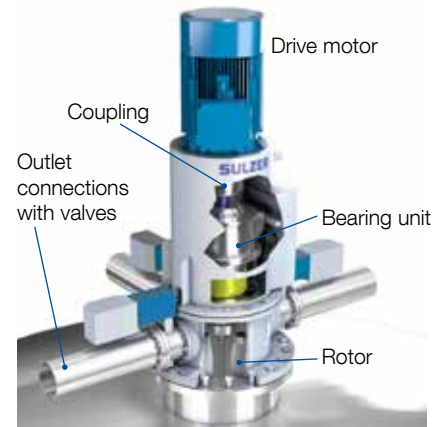

Fig. 21. MC discharger, vertical installation.

The design of the MC discharger is shown in Fig. 21. The MC discharger can be installed either vertically (Fig. 21), horizontally (Fig. 22) or in any other desired position depending on the application.

The discharger sizes cover capacity ranges equal to the MCE-pumps, and EN1.4404 stainless steel, 254SMO or titanium can be selected as the material for the wetted parts.



Fig. 22. MC discharger, horizontal installation.

1.4.8. Parallel pumping of stock from the conical section of a storage tower

This application allows the simultaneous pumping of stock from two locations in the storage tower. From the conical section of the tower, the stock is transferred into the feed chute and pumped by the MCE pump at medium consistency to the following stage in the process. At the same time, stock is being diluted through the lower section of the storage tower and pumped further to the desired location at low consistency. White water from the paper machine can be segregated and two paper machines can be fed from one common storage tower. The pumping system arrangement is shown in Fig. 23 and a typical process application in Fig. 24.

Efficient 'in-line' dilution system for diluting the MC pulp with Dilution Mixer to lower consistency enables to improve existing applications. New energy-efficient pulp dilution systems can be realized without expensive dilution tanks.

1.4.9. Various other MC pumping applications

Sulzer has delivered many special MC pumping applications according to customer needs. Good example is the MC pumping with recirculation back to the tower bottom zone. Existing low consistency tanks, reactors or towers can be converted into MC pumping systems. The recirculation of the pulp enables MC pumping from the small, intermediate or big diameter tanks or towers. This way existing and expensive pumping vessels can be reused. The efficient bleaching of pulp can be done in the MC pumping system, if needed in the process.

The other special MC application is used in the paper mills that have recycled fiber as raw material. MC pulp can be pumped from dispersion into storage tower. The higher inlet pressure coming from disperser to MC booster pump allows simple MDS degassing arrangement and no pressurized drop leg is needed. This way the installation costs are moderate and MC pumping can be done in efficient way.

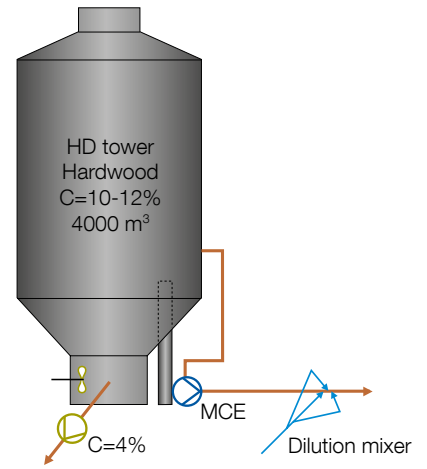

Fig. 24. MC parallel pumping system process application.

2. Mixing of chemicals and steam with SX chemical mixer

Mixing chemicals and stock is one of the most important operations in stock bleaching. Good mixing provides homogenous bleaching conditions, reduces the consumption of chemicals and energy, improves product quality, and reduces the environmental load. Mixing is a key factor in the success of new bleaching sequences.

The stock is fluidized in the MCE pump as the fiber network is disintegrated, and the gas is also separated. This allows the efficient mixing of various liquid chemicals as early as in the pump. Most of these chemicals can be fed at a low pressure to the suction side of the pump. The MCE pump provides a chemical mixing arrangement also for concentrated sulphuric acid applications.

All gaseous chemicals and steam are mixed with a separate SX chemical mixer. The chemical injection points are shown in Fig. 25.

Each chemical and steam has its own features and special detailed selection and dimensioning guidelines that need to be followed when injecting the chemical into the pipeline.

SX chemical mixer is a medium consistency chemical mixer designed for mixing both gaseous and liquid bleaching chemicals into paper stock. The rotor of the mixer fluidizes the stock together with the casing turbulence generators, thus disrupting the fiber network and resulting in optimum mixing, with no gas separation. The unique three-dimensional turbulence zone prevents the separation of gas. An inhomogeneity of 5 to 10% is normally considered acceptable; new SX chemical mixer reaches an inhomogeneity value of as low as 3 to 6%. The design of SX chemical mixer is shown in Fig. 27.

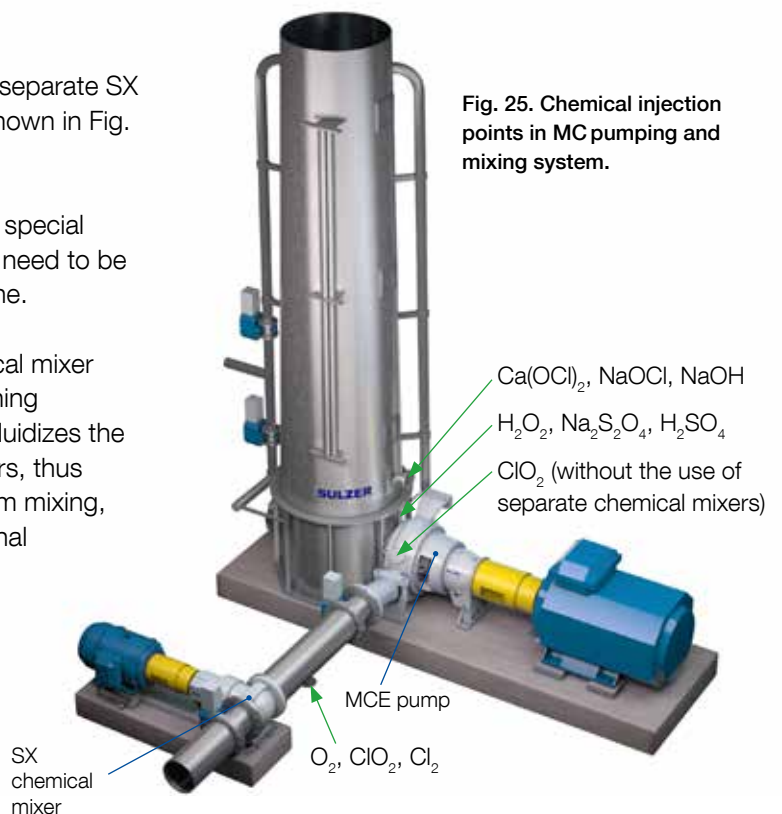

Fig. 25. Chemical injection points in MC pumping and mixing system.

General SX chemical mixer design features are:

- New efficient patented hydraulic design
- Sturdy new design and casing support
- Small pressure drop
- Small size of the mixer and valves and thus small space requirement and light weight
- Easy installation and maintenance (back pull-out design)
- Direct drives
- All flow directions

The SX chemical mixer is used for a consistency range of 3 to 20%, and the product sizes cover capacity ranges up to 5,500 ADMT/d. SX chemical mixer is manufactured from stainless steel, titanium, Hastelloy or 654SMO depending on the chemical mixed and on the bleaching stage arrangement.

In the oxygen delignification stages, oxygen and steam are introduced simultaneously into the steam injection pipe following the MCE pump. No additional flow control or instrumentation is needed in the stock line. Oxygen can also be introduced into the stock through a separate oxygen feeder.

In the SX chemical mixer, oxygen and steam are mixed efficiently into the stock (Fig. 26).

A temperature increase of up to 25°C is to be reached by the SX chemical mixer. Steam consumption is lower due to the closed and pressurized high consistency system. Disturbances and vibrations are eliminated by the correct dimensioning and piping arrangement and by even and smooth steam injection. The optimum flow control and mixing results are achieved with the SX chemical mixer. The power consumption of oxygen and steam mixing assembly is low.

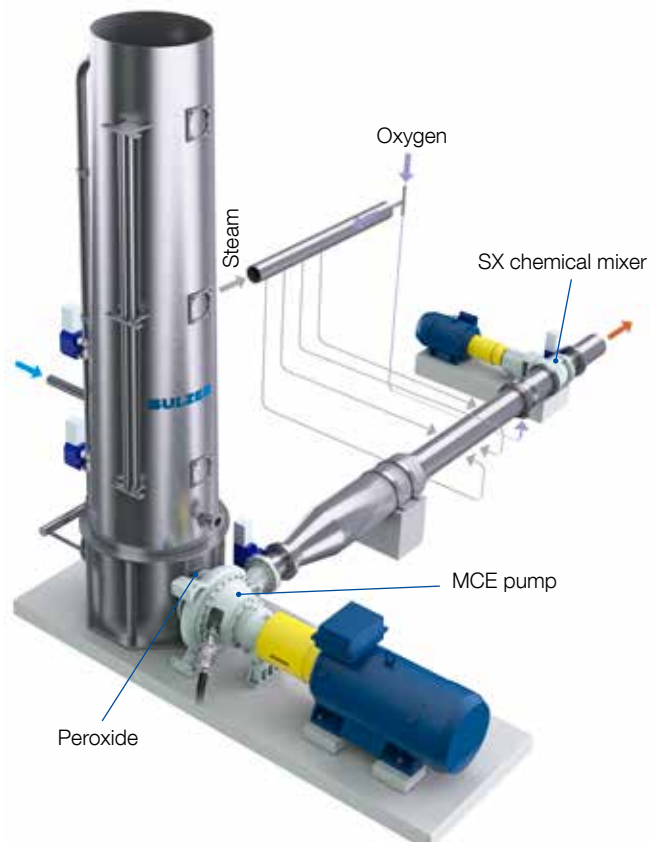

Fig. 26. Oxygen, peroxide and steam mixing.

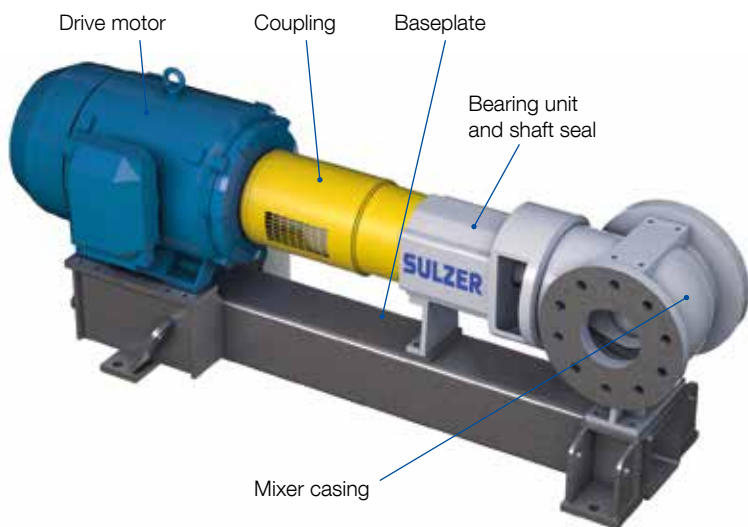

Fig. 27. SX chemical mixer design.



Fig. 28. ClO₂ mixing with chemical mixer.

3. Research and development

Research and development receive top priority at Sulzer. As a result, Sulzer has more than 30 patented inventions and a growing number of pending applications relating to MC pumping, transfer and mixing. At the full scale R&D center, the equipment is tested under process conditions.

Deep metallurgical know-how is also a remarkable strength in developing equipment for these applications where special corrosion and wear resistance is often required.

Sulzer's experience and commitment to the pulp and paper industry have made it a leader in stock pumping, transfer and mixing technology.



Fig. 29. MC equipment testing in the R&D center.

Sulzer innovations for pulp and paper

1980	Medium consistency MC pumping technology
1987	AHLSTAR™ stock/process pump, AHLMIX™ chemical mixer, MC flow discharger
1988-1990	MCA, MCV; the 2nd generation MC pumping systems with external and internal degassing
1991	ZPP low-pulse headbox feed pump
1992	SALOMIX™ SL side entry agitator family
1993	AHLMIX™, the 2nd generation chemical and steam mixer
1995	AHLSTAR™ ASP self-priming gas removal pump
1999-2000	SALOMIX™ TES top entry spreader
2000	SALOMIX™ GLI bottom zone mixing and dilution arrangement
2000	TMS Tower management systems
2000-2001	MCE, the 3rd generation MC pumping system products
2004	The Fluider stock pumping concept
2005	New AHLSTAR™ process pumps
2006	MBN multistage ring section pump
2009	SX chemical mixer
2012	Expanded product portfolio through Cardo Flow Solutions acquisition and Scanpump integration
2013	AHLSTAR™ close coupled process pumps
2011-2016	New product sizes and higher capacities for AHLSTAR™, MCE, KCE and MBN pumps

www.sulzer.com

E00516 en 9.2019, Copyright © Sulzer Ltd 2019
This brochure is a general presentation. It does not provide any warranty or guarantee of any kind. Please, contact us for a description of the warranties and guarantees offered with our products. Directions for use and safety will be given separately. All information herein is subject to change without notice.

