

**SPARE PARTS LIST/ERSATZTEILLISTE/LISTE DE PIÈCES DE RECHANGE**
**AS 0630 S10/4 W/D & S16/4 D 60Hz Std.& FM**

Valid from Serial Number: 100 -

Page :  
 Issue of : 20/10/11  
 Supersedes Issue :  
 Issue No. : 01,02,03,04  
 Drawing ref. Nr. : ANS12057-03

Pos. No.	Part No.	Kit	Qty	Description	Benennung	Designation	Dimensions /Din	Comments	Price
1	31005033		1	Motorhousing	Motorgehäuse	Carcasse moteur			
2	11120829	AB	1	O-ring	O-ring	Joint torique	Ø32x3 DIN3771	Viton	
3	43025563		1	Cable	Kabel	Cable	4x1.5 Tecwater	10m (W/D)	
3	43025569		1	Cable	Kabel	Cable	4x1.5 Tecwater	20m (W/D)	
3	43025657		1	Cable	Kabel	Cable	4x1.5 Tecwater	30m (W/D)	
3	43025540		1	Cable	Kabel	Cable	7x1.5 Tecwater	10m (W)	
3	43025541		1	Cable	Kabel	Cable	7x1.5 Tecwater	20m (W)	
3	43025542		1	Cable	Kabel	Cable	7x1.5 Tecwater	30m (W)	
3	43025535		1	Cable	Kabel	Cable	7x1.5 Tecwater	10m (D)	
3	43025536		1	Cable	Kabel	Cable	7x1.5 Tecwater	20m (D)	
3	43025537		1	Cable	Kabel	Cable	7x1.5 Tecwater	30m (D)	
3	43025204		1	Cable	Kabel	Cable	14/7 SOW-A	10m (W)	
3	43025218		1	Cable	Kabel	Cable	14/7 SOW-A	20m (W)	
3	43025219		1	Cable	Kabel	Cable	14/7 SOW-A	30m (W)	
3	43025203		1	Cable	Kabel	Cable	14/7 SOW-A	10m (D)	
3	43025212		1	Cable	Kabel	Cable	14/7 SOW-A	20m (D)	
3	43025220		1	Cable	Kabel	Cable	14/7 SOW-A	30m (D)	
4	31325008		1	Cable cap	Kabeleinführung	Entree de cable	GG25 (Ø12)	Cable 4x1.5	
4	31320140		1	Cable cap	Kabeleinführung	Entree de cable	GG25 (Ø20)	Cable 4x1.5+3x0.5 Cable 7x1.5 Cable 14/7	
5	42015009		2	Washer	Scheibe	Rondelle	Ø34x18x1.5	Cable 4x1.5 Cable 4x1.5+3x0.5 Cable 7X1.5	
5	42015005		2	Washer	Scheibe	Rondelle	34x19.5x1.5	Cable SOW-A 14/7	
6	11210238		4 (2)	Cylinder screw	Zyl.Blechschaube	Vis à tête plate	M8x30 DIN912	1.4401 (2) Easyfit	
8	43075058	A	1	Cable seal	Kabdichtung	Joint de kabel	Ø34x11.5x29.5H	Cable 4x1.5	
8	43075056	B	1	Cable seal	Kabdichtung	Joint de kabel	Ø34x11.5x29.5H (viton)	Cable 4x1.5	
8	43075048	A	1	Cable seal	Kabdichtung	Joint de kabel	Ø34x16x29.5H	Cable 4x1.5+3x0.5 Cable 7x1.5 SO7RN-F OZ+	
8	43075057	B	1	Cable seal	Kabdichtung	Joint de kabel	Ø34x16x29.5H (viton)	Cable 4x1.5+3x0.5 Cable 7x1.5 SO7RN-F OZ+	
8	43075049	A	1	Cable seal	Kabdichtung	Joint de kabel	Ø34x16.8x29.5H	Cable 7x1.5 TL07RN-F	
8	43075028	A	1	Cable seal	Kabdichtung	Joint de kabel	Ø34x13.8x29.5H	Cable 7x1.5 Tecwater	
8	43075068	B	1	Cable seal	Kabdichtung	Joint de kabel	Ø34x16.8x29.5H (Viton)	Cable 7x1.5 TL07RN-F	
8	43075034	B	1	Cable seal	Kabdichtung	Joint de kabel	Ø34x13.8x29.5H (Viton)	Cable 7x1.5 Tecwater	
8	43075029	A	1	Cable seal	Kabdichtung	Joint de kabel	Ø34x18x29.5H	Cable SOW-A 14/7	
8	43075035	B	1	Cable seal	Kabdichtung	Joint de kabel	Ø34x18x29.5H (viton)	Cable SOW-A 14/7	
9	12180044		3	Butt connection	St. verbinder	Connecteur	Ø1.0-2.5mm		
10	11060005		1	Support Washer	Tragscheibe	Rondelle	Ø20x28x2 DIN988		
11	11010048		1	Ball bearing	Kugellager	Roulement à billes	6304 Z DIN625		
12	11120817	A	1	O-ring	O-ring	Joint torique	Ø160x3 DIN3771		

**SPARE PARTS LIST/ERSATZTEILLISTE/LISTE DE PIÈCES DE RECHANGE**
**AS 0630 S10/4 W/D & S16/4 D 60Hz Std.& FM**

Valid from Serial Number: 100 -

Page :  
 Issue of : 20/10/11  
 Supersedes Issue :  
 Issue No. : 01,02,03,04  
 Drawing ref. Nr. : ANS12057-03

Pos. No.	Part No.	Kit	Qty	Description	Benennung	Designation	Dimensions /Din	Comments	Price
12	11120870	B	1	O-ring	O-ring	Joint torique	Ø160x3 DIN3771	Viton	
13	11080010	AB	1	Circlip	Sicherungsring	Circlips	Ø52x2 DIN472		
14	11110001		1	Mechanical seal	Gleitringdichtung	Garniture mecanique	Ø20mm		
14	11110149		1	Mechanical seal	Gleitringdichtung	Garniture mecanique	Ø20mm (Viton)	Viton	
15	11470072		1	Washer	Scheibe	Rondelle	Ø8.4 DIN9021		
16	11200230		1	Hexagonal screw	Sechskantschraube	Vis hexagonal	M8x16 DIN933		
17	14990008		1	Shackle	Schäkel	Manille	DIN82101		
18	11010013		1	Ball bearing	Kugellager	Roulement à billes	6201 2RSR DIN625		
19	65005347		1	Stator	Wicklung	Stator	208/1/60	S10/4	
19	65005340		1	Stator	Wicklung	Stator	230/1/60	S10/4	
19	65005462		1	Stator	Wicklung	Stator	208/3/60	S10/4,S16/4	
19	65005343		1	Stator	Wicklung	Stator	230/3/60	S10/4,S16/4	
19	65005463		1	Stator	Wicklung	Stator	380/3/60	S10/4,S16/4	
19	65005342		1	Stator	Wicklung	Stator	460/3/60	S10/4,S16/4	
19	65005790		1	Stator	Wicklung	Stator	460/3/60 Without klixon	S10/4,S16/4	
19	65005459		1	Stator	Wicklung	Stator	575/3/60	S10/4,S16/4	
22	65015079		1	Rotor with shaft	Rotor mit Welle	Rotor avec arbre	1.4021	S10/4,S16/4	
22	65015083		1	Rotor with shaft	Rotor mit Welle	Rotor avec arbre	1.4401	S10/4,S16/4	
23	11130003	AB	1	Seal ring	Dichtung	Rondelle joint	Ø6x10 DIN7603		
24	11210253		1	Cylinder screw	Zylinderschraube	Vis à tête cylindrique	M6x10 DIN912		
25	11490020	AB	1	Seal washer	Verschlußscheibe	Rondelle joint	DIN470		
26	11070006	AB	1	Circlip	Sicherungsring	Circlip	Ø20x1.2 DIN471		
27	31155023		1	Bearing lid	Lager deckel	Couvercle palier	GG25	Std./EX EECS	
27	31155035		1	Bearing lid	Lager deckel	Couvercle palier	GG25	Std.Euro/US DI-probe	
27	31155025		1	Bearing lid	Lager deckel	Couvercle palier	GG25	With FM DI-probe	
28	11090009	AB	1	Lip seal	Wellendichtung	Joint à levres	Ø20x52x10 DIN3760		
29	11030046		0.56	Oil	Öl	Huile			
30	11630128		1	Impeller key	Paßfeder	Clavette	6x6x10 DIN6885		
31	35075118		1	Impeller	Lauftrad	Roue	Ø130	S10/4	
31	35075121		1	Impeller	Lauftrad	Roue	Ø160	S16/4	
32	31055021		1	Volute	Kreiselmkammer	Corps de pompe			
33	31065026		1	Bottom plate	Bodenplatte	Plaque de base			
33	31065021		1	Bottom plate	Bodenplatte	Plaque de base		FHA	
34	11650001	AB	1	Locking Washer	Klemmscheibe	Rondelle-frein	M8 PVC/NITR		
34	11120141	AB	1	O-ring	O-ring	Joint torique	Ø7x3 DIN3771		
35	11260104		1	Hexagonal screw	Sechskantschraube	Vis hexagonal	M5x10 DIN85 GV		
36	11500003		1	Locking washer	Sicherungsscheibe	Tole-frein	A5.1 DIN6797		
37	12180014		1	Cable shoe	Flachsteckhülse	Cosse-câble	Ø1.5-2.5mm M5		
40	11530018		3	Spring washer	Federring	Rondelle	Ø10 DIN7980		
41	11210239		3	Cylinder screw	Zylinderschraube	Vis à tête cylindrique	M10x35 DIN912		
42	12120241		1	DI-probe	DI-electrode	Sonde DI	M12		
43	11060014		1	Support washer	Tragscheibe	Rondelle	Ø42x52x2.5 DIN988		
44	11100066		1	Mechanical seal	Gleitringdichtung	Garniture mecanique	Ø20mm		
45	11070006	AB	1	Circlip	Sicherungsring	Circlip	Ø20x1.2 DIN471		
46	43070326		1	Not available	nicht lieferbar	pas disponible			
47				Not available	nicht lieferbar	pas disponible			

**SPARE PARTS LIST/ERSATZTEILLISTE/LISTE DE PIÈCES DE RECHANGE**
**AS 0630 S10/4 W/D & S16/4 D 60Hz Std.& FM**

Valid from Serial Number: 100 -

Page :  
 Issue of : 20/10/11  
 Supersedes Issue :  
 Issue No. : 01,02,03,04  
 Drawing ref. Nr. : ANS12057-03

Pos. No.	Part No.	Kit	Qty	Description	Benennung	Designation	Dimensions /Din	Comments	Price
48				Not available	nicht lieferbar	pas disponible			
49				Not available	nicht lieferbar	pas disponible			
50				Not available	nicht lieferbar	pas disponible			
52	11260100		1	Lens Head Screw	Flachkopfschraube	Vis à tête plate	M8x10 DIN85		
53	12180144		1	Round plug	Rundstecker	Fiche ronde	Ø4mm		
54	42135000		1	DI-probe	DI-electrode	Sonde DI			
55	11080027		1	Circlip	Sicherungsscheibe	Circlip	Ø7x0.9mm DIN6799		
56	43025339		1	Cable EasyFit	Kabel EasyFit	Cable EasyFit	4x1.5 TecWater	10m (W/D)	
56	43025340		1	Cable EasyFit	Kabel EasyFit	Cable EasyFit	4x1.5 TecWater	20m (W/D)	
56	43025341		1	Cable EasyFit	Kabel EasyFit	Cable EasyFit	4x1.5 TecWater	30m (W/D)	
56	43025334		1	Cable EasyFit	Kabel EasyFit	Cable EasyFit	7x1.5 TecWater	10m (W)	
56	43025335		1	Cable EasyFit	Kabel EasyFit	Cable EasyFit	7x1.5 TecWater	20m (W)	
56	43025336		1	Cable EasyFit	Kabel EasyFit	Cable EasyFit	7x1.5 TecWater	30m (W)	
56	43025323		1	Cable EasyFit	Kabel EasyFit	Cable EasyFit	7x1.5 TecWater	10m (D)	
56	43025325		1	Cable EasyFit	Kabel EasyFit	Cable EasyFit	7x1.5 TecWater	20m (D)	
56	43025327		1	Cable EasyFit	Kabel EasyFit	Cable EasyFit	7x1.5 TecWater	30m (D)	
57	11120829		1	O-ring	O-ring	Joint torique	Ø32x3 DIN3771	Viton	
58	12180002		4(7)	Cable shoe	Flachsteckhülse	Cosse-câble		(7) for 7 core cable	
65	11070005	AB	1	Circlip	Sicherungsring	Circlip	Ø20x1.2 DIN471		
66	11210243		3	Cylinder screw	Zylinderschraube	Vis à tête cylindrique	M8x25 DIN912		
67				Not available	nicht lieferbar	pas disponible			
	61195072	A	1	Seal kit	Dichtungssatz	Jeu de joint complet			
	61195076	B	1	Seal kit	Dichtungssatz	Jeu de joint complet	Viton		

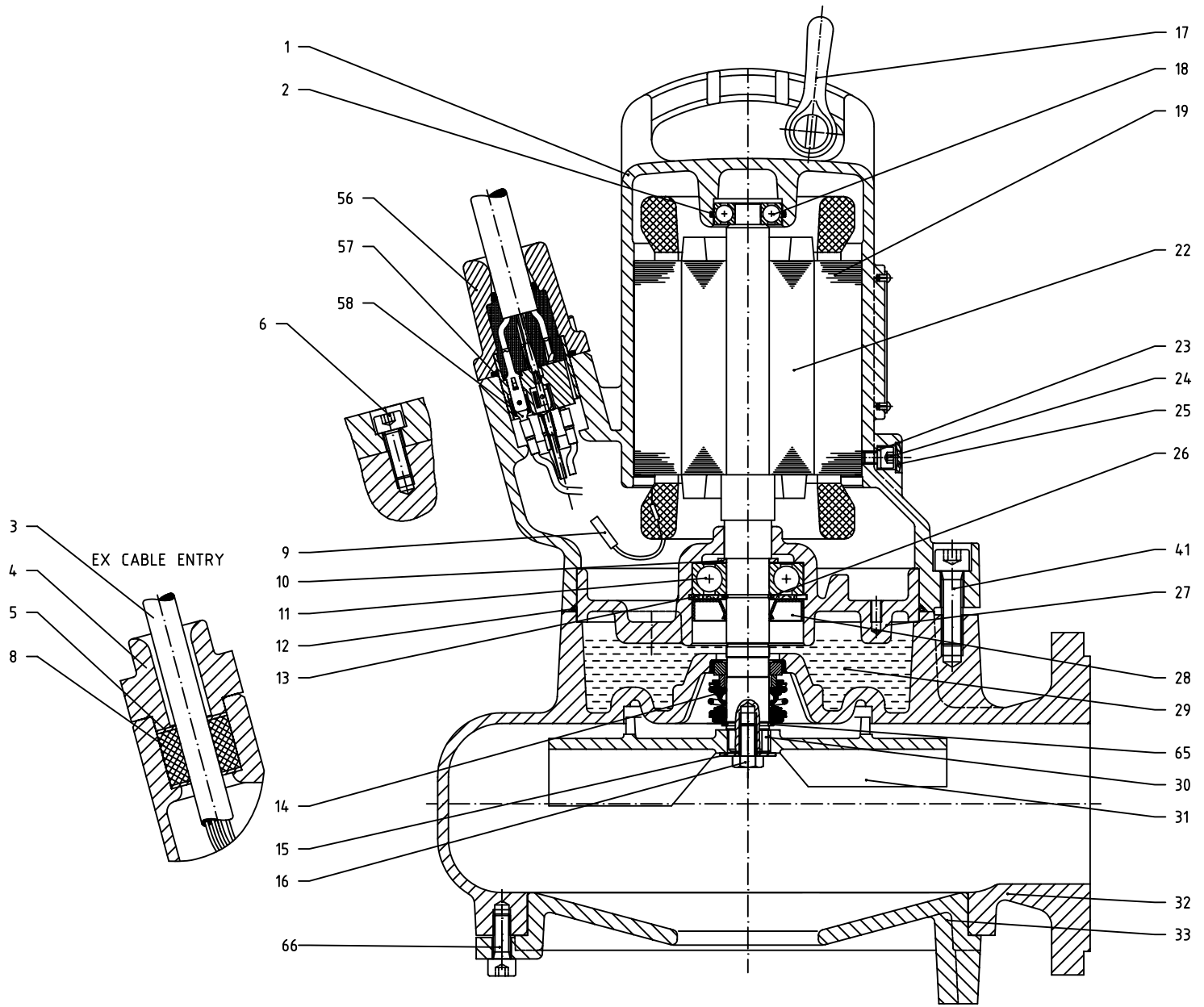

DI (OPTIONAL)  
EX EECS

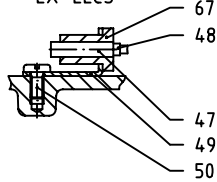

EARTH CONNECTION

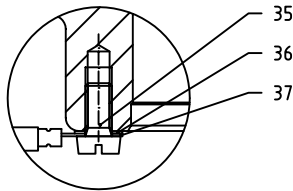

OIL SCREW

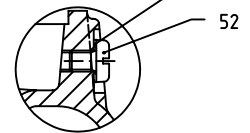

2nd Mech. seal

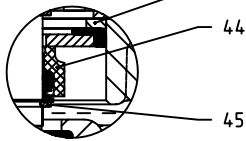

DI (OPTIONAL)  
FM

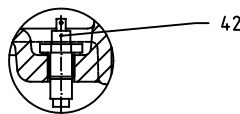

DI (OPTIONAL)  
Std. Euro/USA

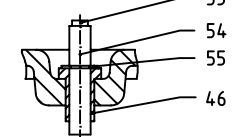

<b>SULZER</b>	SPARE PARTS LIST / ERSATZTEILLISTE	AN-S 12.57 -03
	LIST DE PIÉCES DE RECHANGE	CAD CODE: GADWISS/GVANS12057
	AS0630 S10/4 - S13/4 (50Hz)	DATE/NAME : 31.03.98 C.QUIRKE
	AS0630 S10/4 - S16/4 (60Hz)	Technical changes reserved revisions vorbehalten Sans réserve de modification Product Center: IEM