

**SPARE PARTS LIST/ERSATZTEILLISTE/LISTE DE PIÈCES DE RECHANGE**
**AS 0530 S26/2 D 50Hz Std. & Ex**

Valid from Serial Number: 100 -

Page :  
 Issue of : 20/10/11  
 Supersedes Issue :  
 Issue No. : 01,02,03  
 Drawing ref. Nr. : ANS12088-02

Pos. No.	Part No.	Kit	Qty	Description	Benennung	Designation	Dimensions /Din	Comments	Price
1	31005034		1	Motorhousing	Motorgehäuse	Carcasse moteur			
2	11120468	AB	1	O-ring	O-ring	Joint torique	47x3 DIN3770	Viton	
3	43025563		1	Cable	Kabel	Cable	4x1.5 Tecwater	10m	
3	43025569		1	Cable	Kabel	Cable	4x1.5 Tecwater	20m	
3	43025657		1	Cable	Kabel	Cable	4x1.5 Tecwater	30m	
3	43025535		1	Cable	Kabel	Cable	7x1.5 Tecwater	10m	
3	43025536		1	Cable	Kabel	Cable	7x1.5 Tecwater	20m	
3	43025537		1	Cable	Kabel	Cable	7x1.5 Tecwater	30m	
3	43025545		1	Cable	Kabel	Cable	10x1.5 Tecwater	10m (Star/Delta)	
3	43025546		1	Cable	Kabel	Cable	10x1.5 Tecwater	20m (Star/Delta)	
3	43025547		1	Cable	Kabel	Cable	10x1.5 Tecwater	30m (Star/Delta)	
4	31325008		1	Cable cap	Kabeleinführung	Entree de cable	GG25 (Ø12)	Cable 4x1.5	
4	31320140		1	Cable cap	Kabeleinführung	Entree de cable	GG25 (Ø20)	Cable 4x1.5+3x0.5 Cable 7x1.5 Cable 10x1.5	
5	42015009		2	Washer	Scheibe	Rondelle	Ø34x18x1.5	Cable 4x1.5 Cable 4x1.5+3x0.5 Cable 7x1.5	
5	42015010		2	Washer	Scheibe	Rondelle	Ø34x21x1.5	Cable 10x1.5	
6	11210238		4(2)	Cylinder screw	Zyl.Blechschaube	Vis à tête plate	M8x30 DIN912	(2) EasyFit	
8	43075058	A	1	Cable seal	Kabeldichtung	Joint de kabel	Ø34x11.5x29.5H	Cable 4x1.5	
8	43075056	B	1	Cable seal	Kabeldichtung	Joint de kabel	Ø34x11.5x29.5H (viton)	Cable 4x1.5	
8	43075048	A	1	Cable seal	Kabeldichtung	Joint de kabel	Ø34x16x29.5H	Cable 4x1.5+3x0.5 Cable 7x1.5 SO7RN-F OZ+	
8	43075057	B	1	Cable seal	Kabeldichtung	Joint de kabel	Ø34x16x29.5H (viton)	Cable 4x1.5+3x0.5 Cable 7x1.5 SO7RN-F OZ+	
8	43075049	A	1	Cable seal	Kabeldichtung	Joint de kabel	Ø34x16.8x29.5H	Cable 7x1.5 TL07RN-F	
8	43075028	A	1	Cable seal	Kabeldichtung	Joint de kabel	Ø34x13.8x29.5H	Cable 7x1.5 Tecwater	
8	43075068	B	1	Cable seal	Kabeldichtung	Joint de kabel	Ø34x16.8x29.5H (Viton)	Cable 7x1.5 TL07RN-F	
8	43075034	B	1	Cable seal	Kabeldichtung	Joint de kabel	Ø34x13.8x29.5H (Viton)	Cable 7x1.5 Tecwater	
8	43075052		1	Cable seal	Kabeldichtung	Joint de kabel	Ø34x19x29.5H	Cable 10x1.5	
8	43075059		1	Cable seal	Kabeldichtung	Joint de kabel	Ø34x19x29.5H (Viton)	Cable 10x1.5	
9	12180044		3(6)	Butt connection	St. verbinder	Connecteur	Ø1.0-2.5mm	(6) for 7 core cable	
10	11060006		1	Support washer	Tragscheibe	Rondelle	Ø25x35x2 DIN988		
11	11020006		1	Ball bearing	Kugellager	Roulement à billes	5205 B. DIN628		
12	11120817	A	1	O-ring	O-ring	Joint torique	Ø160x3 DIN3771		
12	11120870	B	1	O-ring	O-ring	Joint torique	Ø160x3 DIN3771	Viton	
13	11080010	AB	1	Circlip	Sicherungsring	Circlips	Ø52x2 DIN472		
14	11110001		1	Mechanical seal	Gleitringdichtung	Garniture mecanique	Ø20mm		
14	11110149		1	Mechanical seal	Gleitringdichtung	Garniture mecanique	Ø20mm (Viton)	Viton	
15	11470072		1	Washer	Scheibe	Rondelle	Ø8.4 DIN9021	1.4301	
16	11210106		1	Cylinder screw	Zylinderschraube	Vis à tête cylindrique	M8x20 DIN912		

**SPARE PARTS LIST/ERSATZTEILLISTE/LISTE DE PIÈCES DE RECHANGE**
**AS 0530 S26/2 D 50Hz Std. & Ex**

Valid from Serial Number: 100 -

Page :  
 Issue of : 20/10/11  
 Supersedes Issue :  
 Issue No. : 01,02,03  
 Drawing ref. Nr. : ANS12088-02

Pos. No.	Part No.	Kit	Qty	Description	Benennung	Designation	Dimensions /Din	Comments	Price
17	11120501	AB	1	O-ring	O-ring	Joint torique	Ø145x4 DIN3771		
18	14990008		1	Shackle	Schäkel	Manille	DIN82101		
19	11010017		1	Ball bearing	Kugellager	Roulement à billes	6204 ZR.C3 DIN625		
20	65005350		1	Stator	Wicklung	Stator	230/3/50		
20	65005349		1	Stator	Wicklung	Stator	400/3/50		
20	65005791		1	Stator	Wicklung	Stator	400/3/50	Without klixon	
20	65005455		1	Stator	Wicklung	Stator	500/3/50		
20	65005466		1	Stator	Wicklung	Stator	400/695/3/50		
23	65015077		1	Rotor with shaft	Rotor mit Welle	Rotor avec arbre	1.4021		
23	65015081		1	Rotor with shaft	Rotor mit Welle	Rotor avec arbre	1.4401		
24	11130003	AB	1	Seal ring	Dichtung	Rondelle joint	Ø6x10 DIN7603		
25	11210253		1	Cylinder screw	Zylinderschraube	Vis à tête cylindrique	M6x10 DIN912		
26	11490020	AB	1	Seal washer	Verschlußscheibe	Rondelle joint	DIN470		
27	11070007	AB	1	Circlip	Sicherungsring	Circlip	Ø25x1.2 DIN471		
28	11530018		3	Spring washer	Federring	Rondelle	Ø10 DIN7980		
29	11210239		3	Cylinder screw	Zylinderschraube	Vis à tête cylindrique	M10x35 DIN912		
30	31155024		1	Bearing lid	Lager deckel	Couvercle palier	GG25	Std./ DI-probe Ex Euro	
30	31155036		1	Bearing lid	Lager deckel	Couvercle palier	GG25	Std.Euro/US DI-probe	
31	11090009	AB	1	Lip seal	Wellendichtung	Joint à levres	Ø20x52x10 DIN3760		
32	11030046		0.48	Oil	Öl	Huile			
33	11070005	AB	1	Circlip	Sicherungsring	Circlip	Ø20x1.2 DIN471		
34	11630128		1	Impeller key	Paßfeder	Clavette	6x6x10 DIN6885		
35	35075216		1	Impeller	Lauftrad	Roue	Ø142		
36	31055042		1	Volute	Kreiselkammer	Corps de pompe			
37	21065022		1	Bottom plate	Bodenplatte	Plaque de base			
38	11470026		3	Washer	Scheibe	Rondelle	A6.4 DIN9021	1.4401	
39	11210240		3	Cylinder screw	Zylinderschraube	Vis à tête cylindrique	M6x20 DIN912		
40	11650001	AB	1	Locking Washer	Klemmscheibe	Rondelle-frein	M8 PVC/NITR		
40	11120141	AB	1	O-ring	O-ring	Joint torique	Ø7x3 DIN3771		
41	11260100		1	Lens Head Screw	Flachkopfschraube	Vis à tête plate	M8x10 DIN85		
42	11260104		1	Hexagonal screw	Sechskantschraube	Vis hexagonal	M5x10 DIN85 GV		
43	11500003		1	Locking washer	Sicherungsscheibe	Tole-frein	A5.1 DIN6797		
44	12180014		1	Cable shoe	Flachsteckhülse	Cosse-câble	Ø1.5-2.5mm		
45	43070326		1	Seal for DI	Dichtung für DI	Joint pour DI			
46	12180144		1	Round plug	Rundstecker	Fiche ronde	Ø4mm		
47	42130403		1	DI-probe	DI-electrode	Sonde DI			
48	41425032		1	Bracket	Haltewinkel	Butée			
49	11260091		1	Lens Head Screw	Flachkopfschraube	*Vis à tête plate	M5x12 DIN85		
50			1	Not available	nicht lieferbar	pas disponible			
51	12180144		1	Round plug	Rundstecker	Fiche ronde	Ø4mm		
52	42135000		1	DI-probe	DI-electrode	Sonde DI			
53	11080027		1	Circlip	Sicherungsscheibe	Circlip	Ø7x0.9mm DIN6799		

**SPARE PARTS LIST/ERSATZTEILLISTE/LISTE DE PIÈCES DE RECHANGE**
**AS 0530 S26/2 D 50Hz Std. & Ex**

Valid from Serial Number: 100 -

Page :  
 Issue of : 20/10/11  
 Supersedes Issue :  
 Issue No. : 01,02,03  
 Drawing ref. Nr. : ANS12088-02

Pos. No.	Part No.	Kit	Qty	Description	Benennung	Designation	Dimensions /Din	Comments	Price
54	43070326		1	Seal for DI	Dichtung für DI	Joint pour DI			
55	11060014		1	Support washer	Tragscheibe	Rondelle	Ø42x52x2.5 DIN988		
56	11100066		1	Mechanical seal	Gleitringdichtung	Garniture mecanique	Ø20mm	CARBON-CHROME	
57	11070006	AB	1	Circlip	Sicherungsring	Circlip	Ø20x1.2 DIN471		
58	43025339		1	Cable EasyFit	Kabel EasyFit	Cable EasyFit	4x1.5 TecWater	10m	
58	43025340		1	Cable EasyFit	Kabel EasyFit	Cable EasyFit	4x1.5 TecWater	20m	
58	43025341		1	Cable EasyFit	Kabel EasyFit	Cable EasyFit	4x1.5 TecWater	30m	
58	43025323		1	Cable EasyFit	Kabel EasyFit	Cable EasyFit	7x1.5 TecWater	10m	
58	43025325		1	Cable EasyFit	Kabel EasyFit	Cable EasyFit	7x1.5 TecWater	20m	
58	43025327		1	Cable EasyFit	Kabel EasyFit	Cable EasyFit	7x1.5 TecWater	30m	
58	43025331		1	Cable EasyFit	Kabel EasyFit	Cable EasyFit	7x1.5 TLO7RN-F	10m ( Star/Delta )	
58	43025332		1	Cable EasyFit	Kabel EasyFit	Cable EasyFit	7x1.5 TLO7RN-F	20m ( Star/Delta )	
58	43025333		1	Cable EasyFit	Kabel EasyFit	Cable EasyFit	7x1.5 TLO7RN-F	30m ( Star/Delta )	
59	11120829		1	O-ring	O-ring	Joint torique	Ø32x3 DIN3771	Viton	
60	12180002		4 (7)	Cable shoe	Flachsteckhülse	Cosse-câble		(7) for 7 core cable	
	61195073	A	1	Seal kit	Dichtungssatz	Jeu de joint complet			
	61195077	B	1	Seal kit	Dichtungssatz	Jeu de joint complet	Viton		

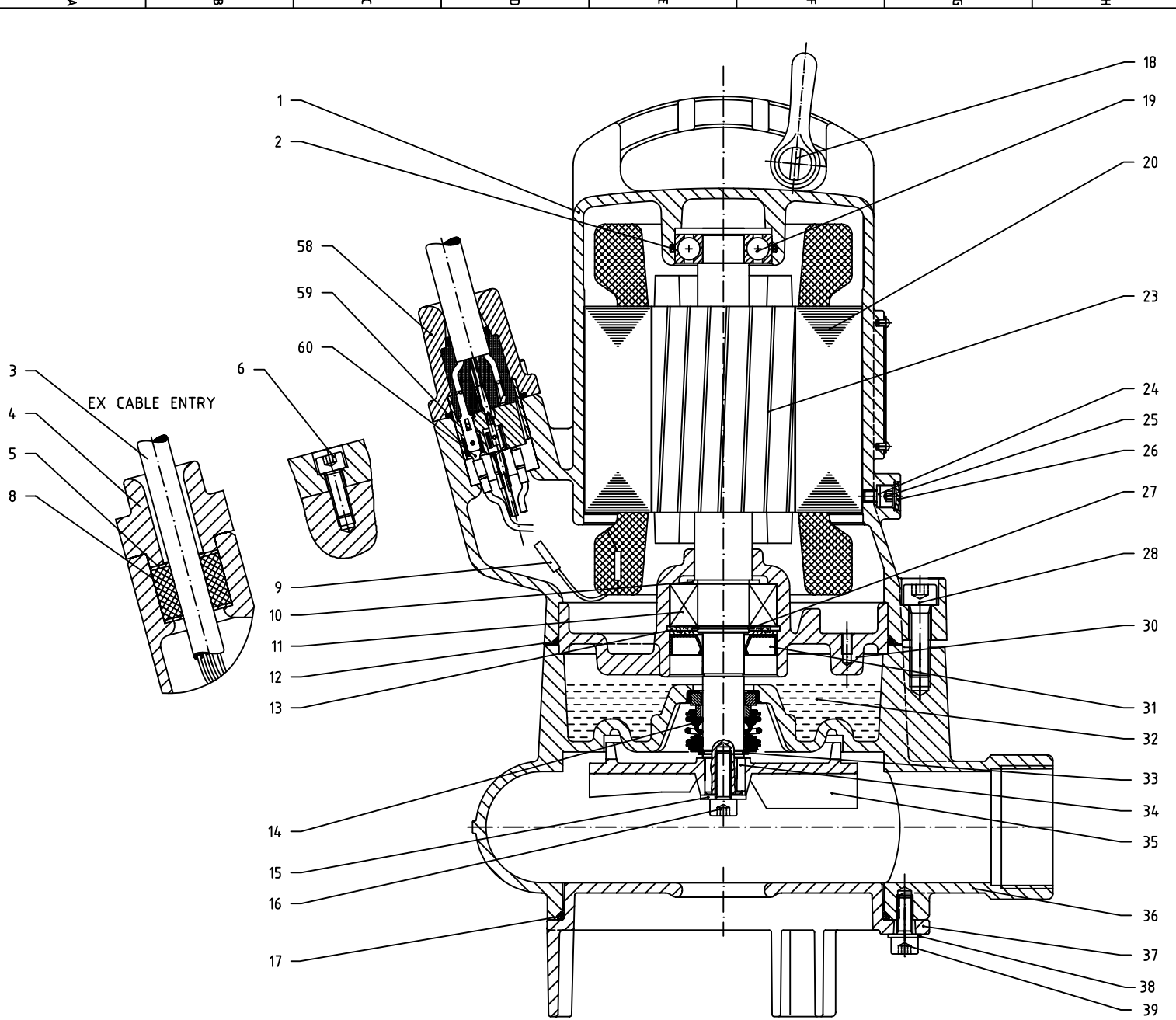

DI (OPTIONAL)  
Std. Euro/USA

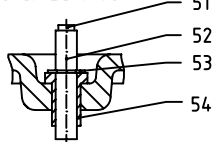

2nd Mech. seal

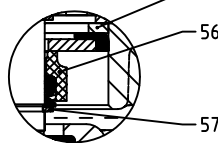

DI (OPTIONAL)  
EX EECS

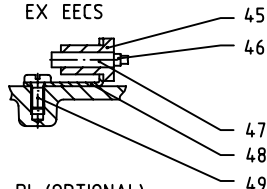

DI (OPTIONAL)  
FM

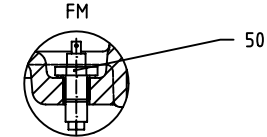

OIL SCREW

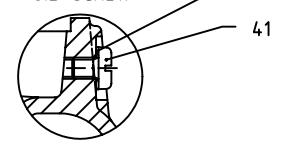

EARTH CONNECTION

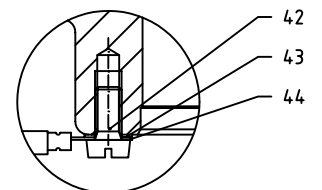

<b>SULZER</b>	SPARE PARTS LIST / ERSATZTEILLISTE LIST DE PIÈCES DE RECHANGE	AN-S 12.88 -02
	AS0530 S26-2 (50Hz) AS0530 S30-2 (60Hz)	CAD CODE: G4DWESLANS12888
		10.11.99 C.OLIVKE
		Technical changes reserved rangian vorbehalten Sans réserve de modification