

SULZER

Original instructions

Installation, operation and maintenance instructions
Submersible Wastewater Pump Type ABS AS 0530 -
0841



Table of contents

- 1. Important notice..... 4**
- 2. Symbols and notices..... 4**
- 3. General..... 5**
 - 3.1. Hydraulics..... 5
 - 3.2. Intended use and application..... 5
 - 3.3. Identification code..... 5
- 4. Performance range..... 6**
- 5. Safety..... 7**
 - 5.1. Personal protective equipment..... 7
- 6. Use of motors in Ex zones..... 7**
 - 6.1. Approvals..... 7
 - 6.2. Explosion-proof approvals..... 7
 - 6.3. General information..... 7
 - 6.4. Special conditions for safe use of S-type, explosion-proof motors..... 8
 - 6.5. Operation of explosion-proof submersible pumps in wet well installation..... 8
- 7.1. Technical data..... 8**
- 7.2. Nameplates..... 8**
 - 7.2.1. Nameplate drawings..... 9
- 8. General design features..... 11**
- 9. Weights..... 13**
 - 9.1. AS - 50 Hz..... 13
 - 9.2. AS - 60 Hz..... 13
 - 9.3. Chain (EN 818)*..... 14
- 10. Lifting, transport and storage..... 14**
 - 10.1. Lifting..... 14
 - 10.2. Transport..... 15
 - 10.3. Storage..... 15
 - 10.3.1. Moisture protection of motor connection cable..... 16
- 11. Setup and installation..... 16**
 - 11.1. Equipotential bonding..... 16
 - 11.1.1. Connection point..... 17
 - 11.2. Discharge line..... 17
 - 11.3. Installation types..... 18
 - 11.3.1. Submerged in a concrete sump..... 18
 - 11.3.2. Dry-installed..... 20
 - 11.3.3. Transportable..... 22
 - 11.3.4. Venting of the volute..... 22
- 12. Electrical connection..... 23**
 - 12.1. Seal monitoring..... 24
 - 12.2. Temperature monitoring..... 25
 - 12.2.1. Temperature sensor bimetal..... 25
 - 12.3. Wiring diagrams..... 26
- 13. Commissioning..... 27**
 - 13.1. Types of operation and frequency of starting..... 27
 - 13.2. Direction of rotation..... 28

13.2.1. Checking direction of rotation.....28

13.2.2. Changing direction of rotation.....29

14. Maintenance and service.....29

14.1. General maintenance instructions.....29

14.2. Oil filling and changing.....30

14.3. Oil quantities (liters).....30

14.4. Bottom plate adjustment (Contrablock).....31

14.5. Re-setting the clearance gap following wear.....31

 14.5.1. AS 0641 and 0840.....31

 14.5.2. AS 0831 and 0841.....32

14.6. Bearings and mechanical seals.....32

14.7. Changing the power cable.....32

14.8. Clearing pump blockage.....33

 14.8.1. Instructions for operator.....33



 14.8.2. Instructions for service personnel.....33

14.9. Cleaning.....34













15. Troubleshooting guide.....34

16. Company details.....35

1. Important notice

	NOTE
	The original version of this document is in English. All other languages are a translation of the original. In case of a discrepancy, the English version will prevail.
	NOTE
	The layout and wording of the online version of this manual may vary from the printed version. The same information is provided in both.

2. Symbols and notices

	 DANGER
	Presence of dangerous voltage
	 DANGER
	Danger of an explosion occurring.
	 WARNING
	Hot surface - danger of burn or injury.
	 WARNING
	Hot liquid - danger of burn or injury.
	 CAUTION
	Non-compliance may result in personal injury.
	ATTENTION
	Non-observance may result in damage to the unit or negatively affect its performance.
	NOTE
	Important information for particular attention.

3. General

	NOTE
	Sulzer reserves the right to alter specifications due to technical developments.

3.1. Hydraulics

Table 1.

Submersible Wastewater Pump Type ABS AS:							
0530	0630	0631	0641	0830	0831	0840	0841

3.2. Intended use and application

AS pumps have been designed for the economical and reliable pumping of commercial and industrial sewage and can be installed dry or wet. They are suitable for modern sewage installation systems and are suitable for pumping of the following liquids:

- Clean water and wastewater
- Sewage containing solids and fibrous material
- Faecal matter

These units must not be used in certain applications e.g. operating within flammable, combustible, chemical, corrosive, or explosive liquids.

	ATTENTION
	The maximum allowable temperature of the medium pumped is 40 °C / 104 °F.

	ATTENTION
	Leakage of lubricants could result in pollution of the medium being pumped.

	ATTENTION
	Always consult with your local Sulzer representative for advice on approved use and application before installing the unit.

3.3. Identification code

Table 2.

e.g. AS 0840 S 12/2 Ex	
Hydraulics:	Motor:
AS = Product range	S = Modular motor version

table continued

e.g. AS 0840 S 12/2 Ex	
Hydraulics:	Motor:
08 = Discharge outlet DN (cm)	12 = Motor power P_2 kW x 10
40 = Hydraulic type	2 = Number of poles
	Ex = Explosion proof

4. Performance range

Figure 1. Contrablock impeller 50 Hz / 60 Hz

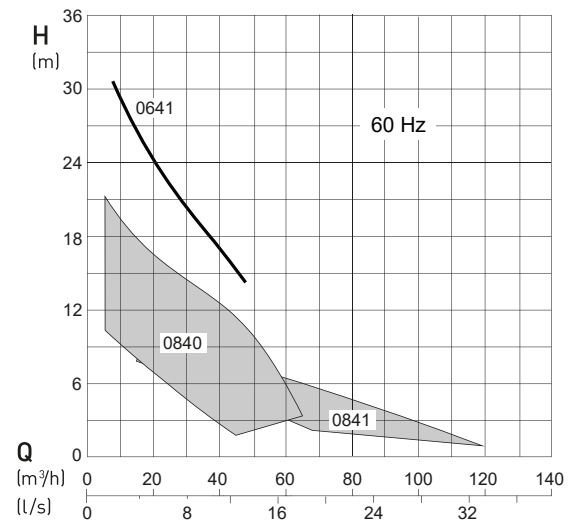
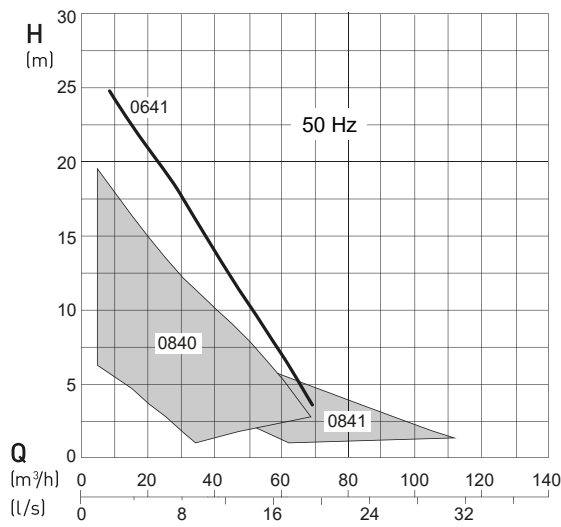
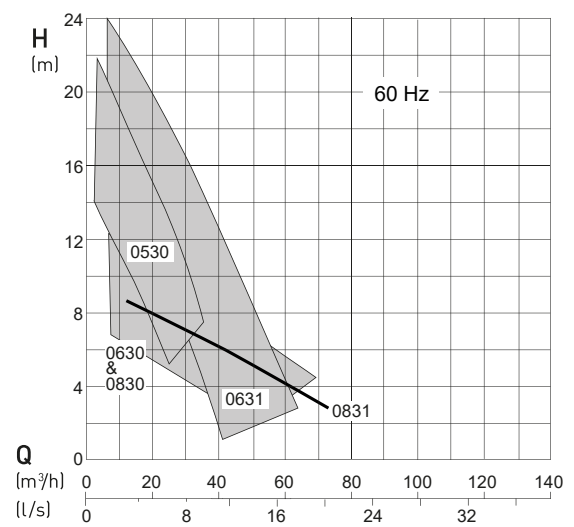
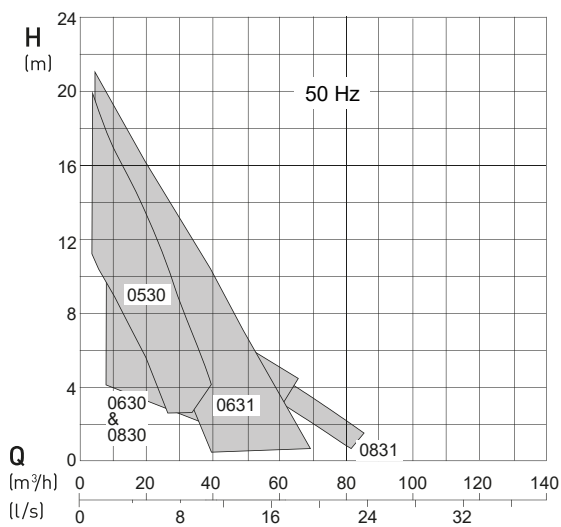



Figure 2. Vortex impeller 50 Hz / 60 Hz



5. Safety

The general and specific health and safety guidelines are described in detail in the “Safety Instructions for Sulzer Products Type ABS” booklet. If anything is unclear, or you have any questions regarding safety make certain to contact the manufacturer Sulzer.

This unit can be used by children aged 8 years and above, and persons with reduced physical, sensory, or mental capabilities, or lack of experience and knowledge, when they have been given supervision or instruction concerning the safe use of the device and understand the hazards involved. Children must not play with the appliance. Cleaning and user maintenance should not be performed by children without supervision.

	 CAUTION
	<p>Under no circumstances place a hand inside the suction or discharge openings unless the pump is completely isolated from the power supply.</p>

5.1. Personal protective equipment

Submersible electrical units can present mechanical, electrical, and biological hazards to personnel during installation, operation, and service. It is obligatory that appropriate personal protective equipment (PPE) is used. The minimum requirement is the wearing of safety glasses, footwear, and gloves. However, an on-site risk assessment should always be carried out to determine if additional equipment is required e.g. safety harness, breathing equipment etc.

6. Use of motors in Ex zones

6.1. Approvals



Electrical safety is CSA and CSA(U) approved.

6.2. Explosion-proof approvals

Explosion-proof motors of this series have certification in accordance with Factory Mutual (FM) Class 1Div. 1 Groups C and D (60 Hz, US), and ATEX 2014/34/EU [II 2G Ex db h IIB T4 Gb] (50 Hz).

	NOTE
	<p>Ex protection method type c “Constructional Safety” and k “Liquid immersion” in accordance with EN ISO 80079-36, EN ISO 80079-37 are used.</p>

6.3. General information

	 DANGER
	<p>Danger of explosion In hazardous areas care must be taken that during switching on and operation of the unit, the hydraulic section is filled with water (dry installation) or alternatively is submerged (wet well installation).</p>

Other types of operation e.g. snore operation or dry running are not allowed!

1. Explosion-proof submersible units may only be operated with the thermal sensing system connected.
2. Temperature monitoring of explosion-proof submersible units must be carried out by bi-metallic temperature limiters or thermistors according to DIN 44 082 connected to a suitable release device which is certified in accordance with EC directive 2014/34/EU and FM 3610.
3. Float switches, and any external seal monitoring (leakage sensor (DI), must be connected via an intrinsically safe electrical circuit, Protection Type EX (i), in accordance with IEC 60079-11 and FM 3610.
4. In the event that the unit is to be operated in explosive atmospheres using a variable speed drive (VFD), please contact your local Sulzer representative for technical advice regarding the various approvals and standards concerning thermal overload protection.

	ATTENTION
	Some units are approved for use in hazardous locations, and are fitted with a nameplate containing technical data and Ex certification. Repair work on Ex rated units must be carried out in Ex approved workshops by qualified personnel, using original parts supplied by the manufacturer. Otherwise it must no longer be used in hazardous locations, and where fitted, the Ex nameplate must be removed and replaced by a standard version.

	NOTE
	All local regulations and guidelines must be followed without exception.

6.4. Special conditions for safe use of S-type, explosion-proof motors

1. The integral supply cable shall be suitably protected from mechanical damage and terminated within an appropriate termination facility.
2. Pump motors rated for use with 50 Hz / 60 Hz sinusoidal supplies shall have the thermal protection devices connected in such a way that the machine is isolated from the supply in the event of the stator reaching 130 °C / 266 °F.
3. These motor units are not intended for user service or repair, any operation that may affect the explosion protection characteristics should be referred to the manufacturer. Repairs on flameproof joints may only be performed in accordance with the manufacturer’s design specifications. Repair on the basis of the values in tables 2 and 3 of EN 60079-1 or annex B and D of FM 3615 is not permitted.

6.5. Operation of explosion-proof submersible pumps in wet well installation

It must be ensured that the hydraulic of the Ex submersible pump is always fully submerged during start-up and operation!

7.1. Technical data

Maximum noise level ≤ 70 dB. In some types of installations it is possible that during operation the noise level of 70 dB(A) or the measured noise level may be exceeded.

Detailed technical information is available in the technical data sheet which can be downloaded from <https://www.sulzer.com>

7.2. Nameplates

Some units are approved for use in hazardous locations, and are fitted with a nameplate containing technical data and Ex certification. Repair work on Ex rated units must be carried out in Ex approved workshops by qualified personnel, using original parts supplied by

the manufacturer. Otherwise it must no longer be used in hazardous locations, and where fitted, the Ex nameplate must be removed and replaced by a standard version.

We recommend that you record the data from the standard nameplate on the unit in the legend below, and maintain it as a source of reference for the ordering of spare parts, repeat orders and general queries.

Always state the type, item number and serial number in all communications.

7.2.1. Nameplate drawings

Figure 3. Ex and standard

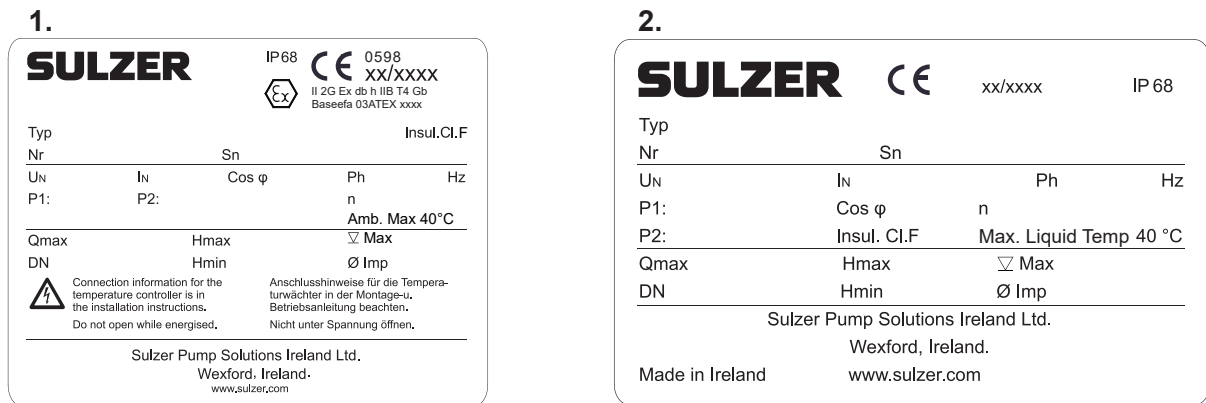

- 1 Ex version
- 2 Standard version

Table 3. Legend

Legend	Description	Data
Typ	Pump type	
Nr	Item No.	
Sn	Serial No.	
xx/xxxx	Production date (Week/Year)	
U _N	Rated voltage	V
I _N	Rated current	A
Ph	Number of phases	Hz
Hz	Frequency	Hz
P1	Rated input power	kW
P2	Rated output power	kW / hp
Cos φ	Power factor	pf
Qmax	Maximum flow	m ³ / h / gpm
DN	Discharge diameter	mm / ins
Hmax	Maximum head	m / ft

table continued

Legend	Description	Data
Hmin	Minimum head	m / ft
∇ Max	Maximum submergence depth	m
Ø Imp	Impeller diameter	mm / ins

Figure 4. FM and CSA

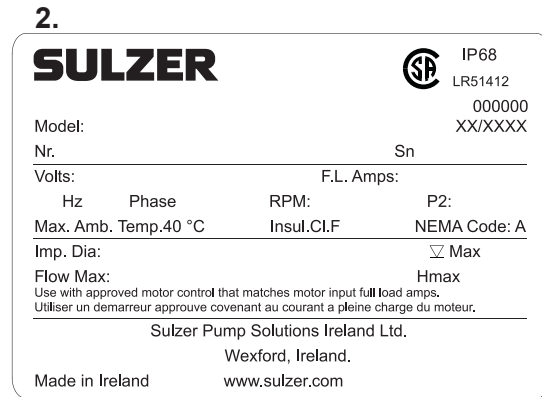
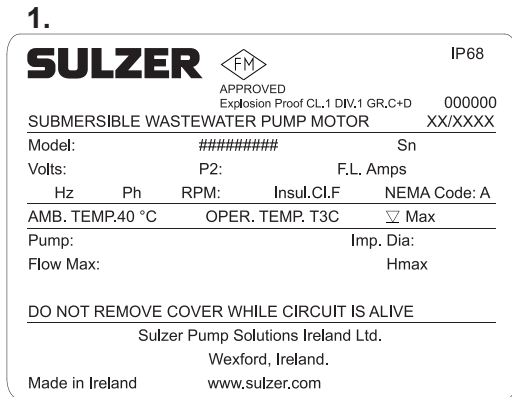

- 1 FM version
- 2 CSA version (standard Canada)

Table 4. Legend (FM and CSA)

Legend	Description	Data
Model (FM)	Motor type	
Model (CSA)	Pump type	
Pump	Pump type	
#####	Item no.	
Sn	Serial no.	
Nr	Item no.	
xx/xxxx	Production date (week/year)	
Volts	Rated voltage	V
P2	Rated output power	kW
F.L.Amps	Full load amps	A
Hz	Frequency	
Ph	Number of phases	
RPM	Speed	rpm
Imp. dia	Impeller diameter	mm
∇ Max	Max. submergence depth	m

table continued

Legend	Description	Data
Flow Max	Rated discharge	m ³ h
Hmax	Max. head	m

8. General design features

AS is a submersible sewage and wastewater pump. The water-pressure-tight, encapsulated, flood-proof motor and the pump section form a compact, robust, modular construction.

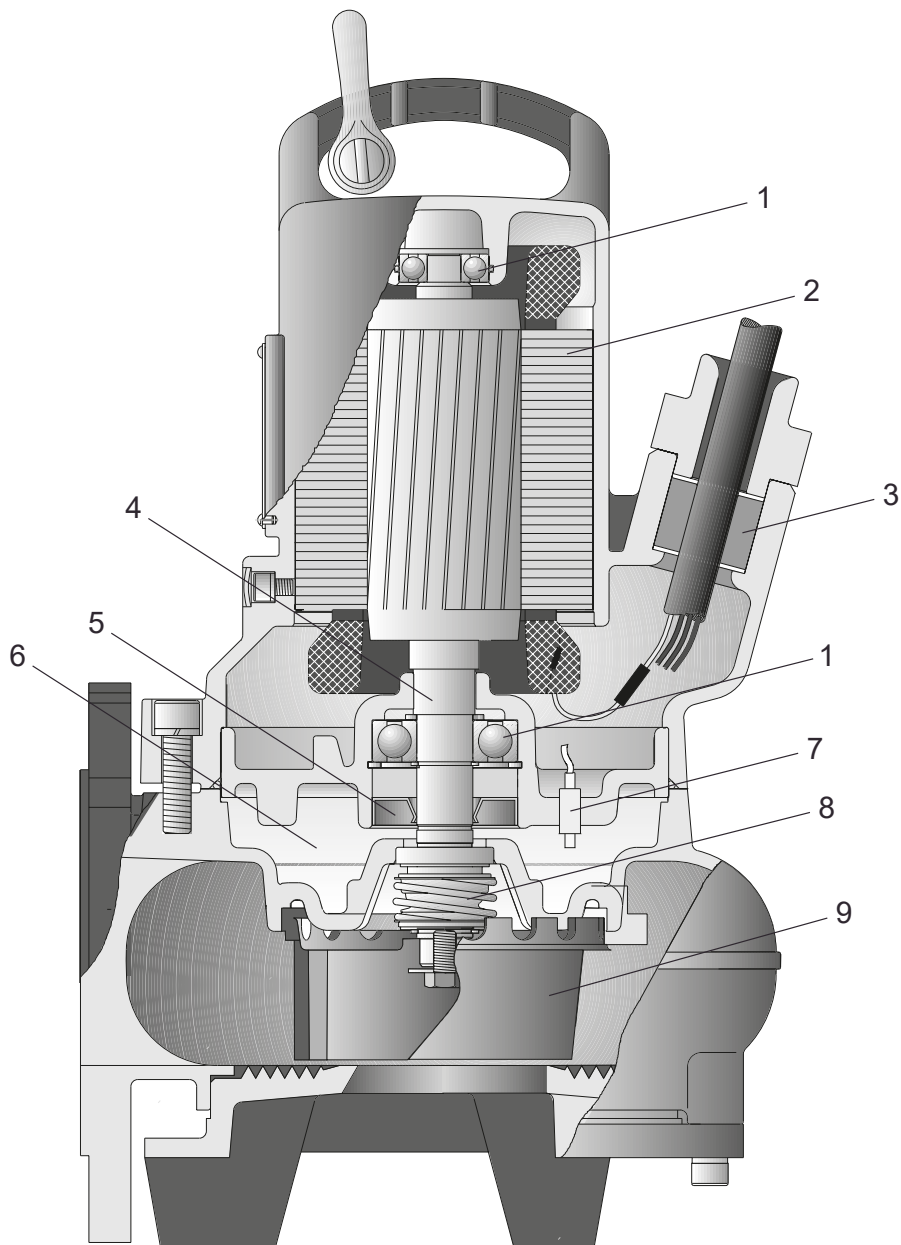

- 1 Lubricated-for-life ball bearings
- 2 Motor with thermal sensor in air-filled motor housing
- 3 Watertight cable entry
- 4 Stainless steel shaft
- 5 Lipseal
- 6 Seal chamber
- 7 Leakage sensor (DI)
- 8 Sic/Sic mechanical seal
- 9 Impeller - Contrablock version

9. Weights

!	NOTE
	Weight on nameplate is for pump and cable only.

9.1. AS - 50 Hz

Table 5.

AS		Pedestal bracket and fasteners (kg)	Horizontal supports (kg)	Transportable pump stand (kg)	Pump* (kg)
0530	S12/2W, S12/2D, S17/2D	2	n.a.	n.a.	34
	S26/2D	2	n.a.	n.a.	40
0630	S10/4W, S13/4D	3	1.2	2.7	37
	S22/4D	3	1.2	2.7	42
0631	S12/2W, S12/2D, S17/2W, S17/2D	3	n.a.	3.5	38
	S30/2D	3	n.a.	3.5	46
0641	S30/2D	3	n.a.	3.5	42
0830	S10/4W, S13/4D	2	1.2	2.7	40
	S22/4D	2	1.2	2.7	42
0831	S22/4D	2	6.5	6.0	45
0840	S12/2W, S12/2D, S17/2D	2	1.2	n.a.	35
	S26/2D	2	1.2	n.a.	40
0841	S13/4D	2	6.5	6.0	41
	S22/4D	2	6.5	6.0	56
*With 10 m cable					

9.2. AS - 60 Hz

Table 6.

AS		Pedestal bracket and fasteners (kg)	Horizontal supports (kg)	Transportable pump stand (kg)	Pump* (kg)
0530	S16/2W, S16/2D, S18/2W, S18/2D	2	n.a.	n.a.	34
	S30/2D	2	n.a.	n.a.	40

table continued



AS		Pedestal bracket and fasteners (kg)	Horizontal supports (kg)	Transportable pump stand (kg)	Pump* (kg)
0630	S10/4W, S10/4D, S16/4D	3	1.2	2.7	37
	S25/4D	3	1.2	2.7	42
0631	S16/2W, S16/2D, S18/2W, S18/2D	3	n.a.	3.5	38
	S35/2D	3	n.a.	3.5	46
0641	S35/2D	3	n.a.	3.5	42
0830	S10/4W, S10/4D, S16/4D	2	1.2	2.7	40
	S25/4D	2	1.2	2.7	42
0831	S25/4D	2	6.5	6.0	55
0840	S16/2W, S16/2D, S18/2W, S18/2D	2	1.2	n.a.	35
	S30/2D	2	1.2	n.a.	40
0841	S16/4D	2	6.5	6.0	48
	S25/4D	2	6.5	6.0	57

*With 10 m cable

9.3. Chain (EN 818)*

Length (m / ft)	Weight (kg / lbs)		
	WLL 320	WLL 400	WLL 630
1.6 / 5.24	0.74 / 1.63	-	-
3.0 / 9.84	1.28 / 2.82	1.62 / 3.57	2.72 / 5.99
4.0 / 13.12	1.67 / 3.68	2.06 / 4.54	3.40 / 7.49
6.0 / 19.68	2.45 / 5.40	2.94 / 6.48	4.76 / 10.49
7.0 / 22.96	2.84 / 6.26	3.38 / 7.45	4.92 / 10.84

* For chain supplied by Sulzer only.

	 CAUTION
	Weights of accessories, other than or in addition to those listed, must also be included when specifying the working load of any lifting equipment. Please consult with your local Sulzer representative prior to installation.

10. Lifting, transport and storage

10.1. Lifting

	ATTENTION
	Observe the total weight of the Sulzer units and their attached components! (see nameplate for weight of base unit).

The duplicate nameplate provided must always be located and visible close to where the unit is installed (e.g. at the terminal boxes / control panel where the cables are connected).

	NOTE
	Lifting equipment must be used if the total unit weight and attached accessories exceeds local manual lifting safety regulations.

The total weight of the unit and accessories must be observed when specifying the safe working load of any lifting equipment! The lifting equipment, e.g. crane and chains, must have adequate lifting capacity. The hoist must be adequately dimensioned for the total weight of the Sulzer units (including lifting chains or steel ropes, and all accessories which may be attached). The end user assumes sole responsibility that lifting equipment is certified, in good condition, and inspected regularly by a competent person at intervals in accordance with local regulations. Worn or damaged lifting equipment must not be used and must be properly disposed of. Lifting equipment must also comply with the local safety rules and regulations

	NOTE
	The guidelines for the safe use of chains, ropes and shackles supplied by Sulzer are outlined in the Lifting Equipment manual provided with the items and must be fully adhered to.

Related concepts

[Nameplate drawings](#) on page 9

10.2. Transport

During transport, care should be taken that the pump cannot fall over or roll and cause damage to the pump or injury to the person. The pumps have a lifting hoop for lifting or suspension of the pump.

	CAUTION
	After removal from its original packaging we recommend that during future transportation of the pump it is laid on its side and securely strapped to a pallet.

	DANGER
	Dangerous voltage The pump must be raised only by the lifting hoop and never by the power cable.

10.3. Storage

1. During long periods of storage the pump should be protected from moisture and extremes of cold or heat.
2. To prevent the mechanical seals from sticking it is recommended that occasionally the impeller is rotated by hand.
3. If the pump is being taken out of service the oil should be changed before storage.
4. After storage the pump should be inspected for damage, the oil level should be checked, and the impeller checked to ensure it rotates freely.

10.3.1. Moisture protection of motor connection cable

	ATTENTION
	The ends of the cables should never be immersed in water as the protective covers only provide protection against water spray or similar (IP44) and are not a water tight seal. The covers should only be removed immediately prior to connecting the pumps electrically.

During storage or installation, prior to the laying and connection of the power cable, particular attention should be given to the prevention of water damage in locations which could flood.

	ATTENTION
	If there is a possibility of water ingress then the cable should be secured so that the end is above the maximum possible flood level. Take care not to damage the cable or its insulation when doing this.



11. Setup and installation

These pumps are designed for wet well vertical installation on a fixed pedestal or as transportable on a pump stand. The pumps are also suitable for horizontal or vertical dry installation (except 0631, 0641) or vertical (only 0831, 0841).

The regulations of DIN 1986 as well as local regulations should be observed when installing the pump.

The following guidelines must be observed when setting the lowest switch off point.

- Care must be taken during switching on and operation that the hydraulic section is filled with water (dry installation) or alternatively is submerged or under water (wet installation). Other types of operation e.g. snore operation or dry running are not allowed!
- The minimum submergence allowed for specific pumps can be found on the dimension installation sheets available by download from <https://www.sulzer.com>

	 DANGER
	<p>Dangerous voltage</p> <p>The regulations covering the use of pumps in sewage applications, together with all regulations involving the use of explosion-proof motors, should be observed. The cable ducting to the control panel should be sealed off in a gas-tight manner by the use of a foaming material after the cable and control circuits have been pulled through. In particular the safety regulations covering work in enclosed areas in sewage plants should be observed together with general good technical practice.</p>

11.1. Equipotential bonding

	 DANGER
	<p>Dangerous voltage</p> <p>In pump stations/tanks, equipotential bonding must be carried out according to EN60079-14:2014 [Ex] or IEC 60364-5-54 [non-Ex] (Regulations for the installation of pipelines, protective measures in high voltage systems).</p>

11.1.1. Connection point

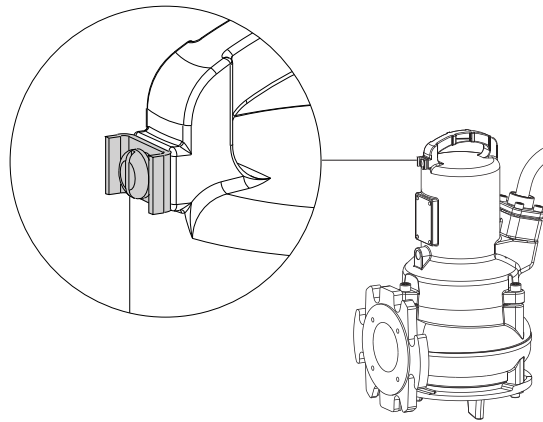

11.2. Discharge line

The discharge line must be installed in compliance with the relevant regulations. DIN 1986/100 and EN 12056 applies in particular to the following:

- The discharge line should be fitted with a backwash loop (180° bend) located above the backwash level and should then flow by gravity into the collection line or sewer.
- The discharge line should not be connected to a down pipe.
- No other inflows or discharge lines should be connected to this discharge line.



ATTENTION

The discharge line should be installed so that it is not affected by frost.

11.3. Installation types

11.3.1. Submerged in a concrete sump

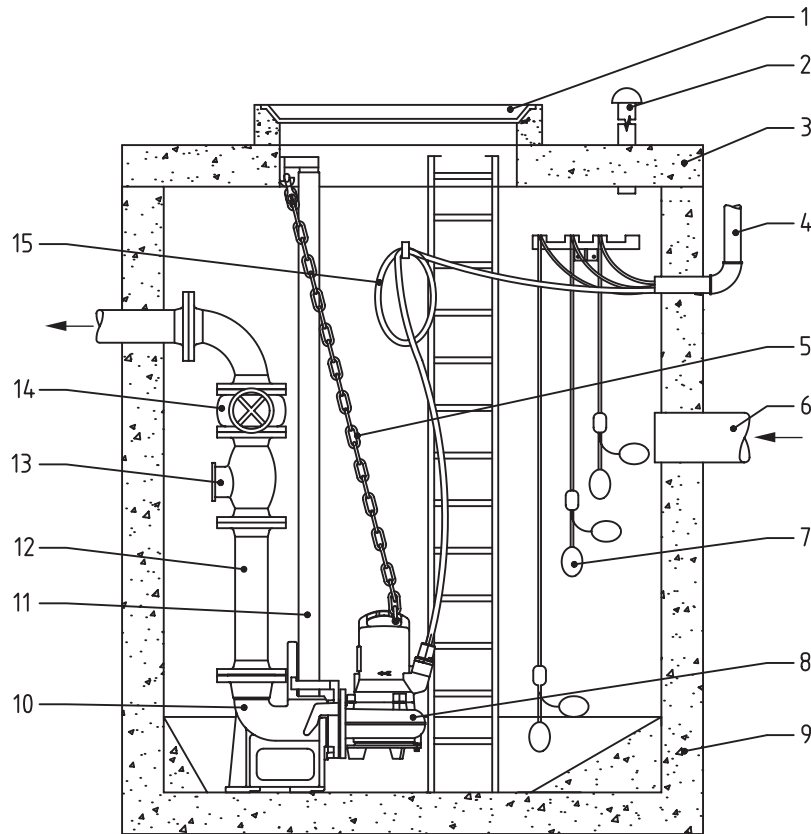

- 1 Sump cover
- 2 Venting line
- 3 Sump cover
- 4 Sleeve for cable ducting to the control panel
- 5 Chain
- 6 Inflow line
- 7 Ball-type float switch
- 8 Submersible pump
- 9 Concrete sump
- 10 Pedestal
- 11 Guide rail
- 12 Discharge line
- 13 Non-return valve
- 14 Gate valve
- 15 Power cable to motor

The pump is installed using the Sulzer pedestal kit as specified below for the particular AS model (assembly leaflet is supplied with the kit).

AS	Size	Part number
0530	2" without bend	62320560
0630, 0631, 0641	DN 65: 90° cast bend	62320673
0830, 0831, 0840, 0841	DN 80 without bend	62320557
	DN 80: 90° cast bend	62320649
	DN 80: 90° cast bend (plug/clamp connection)	62320650

Particular attention should be paid to:

- the provision of venting to the sump.
- installation of isolating valves on the discharge line.
- removal of any slack from the power cable by coiling and securing it to the sump wall so that it cannot be damaged during operation of the pump.

!	ATTENTION
	<p>The power cable should be handled carefully during installation and removal of the pump in order to avoid damage to the insulation. When raising the pump out of the concrete sump with the hoist ensure that the connection cables are lifted out simultaneously as the pump itself is being raised.</p>

11.3.1.1. Lowering of the pump on the guide rail

About this task

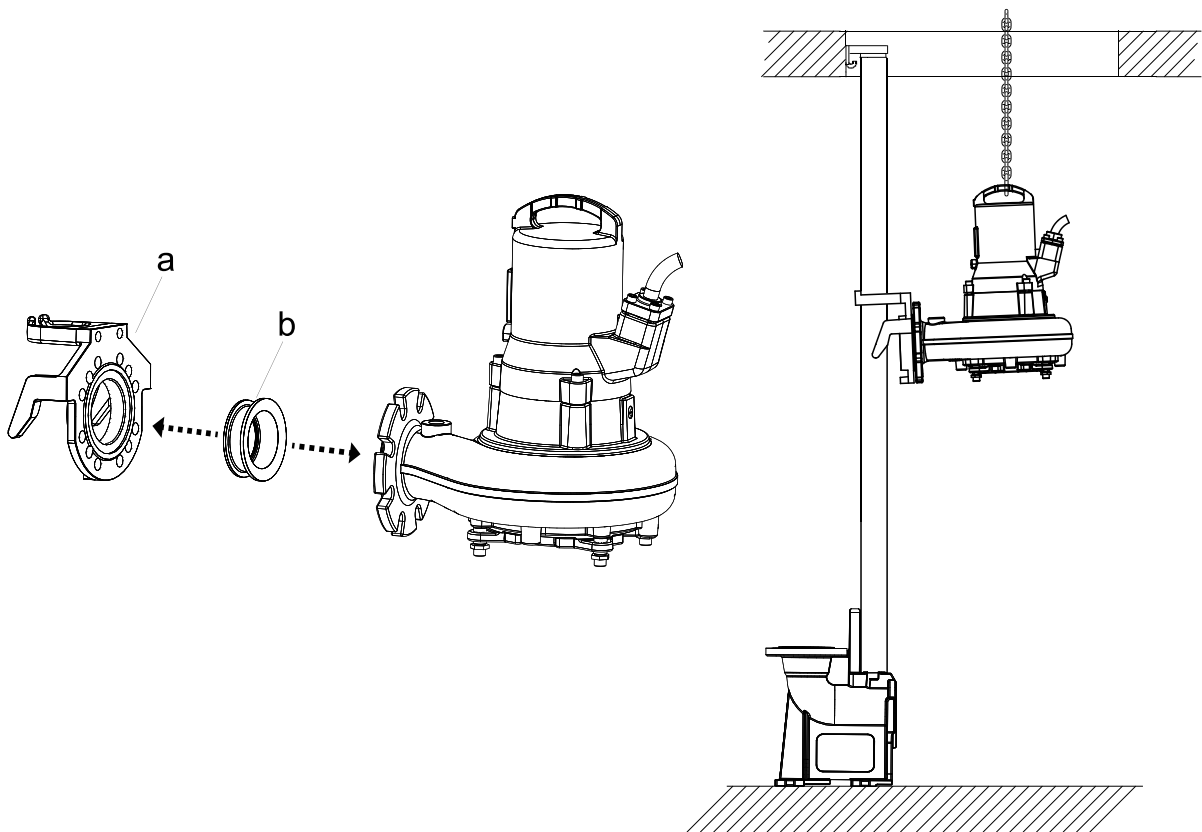

Procedure

1. Fit the pedestal coupling bracket (a) and seal (b) to the discharge flange of the pump.
2. Fit a chain and shackle to the lifting hoop and using a hoist lift the pump into position where the pedestal bracket can slide into place on the guide rail
3. Lower the pump slowly down along the guide rail at a slight angle.
4. The pump couples automatically on the pedestal, and seals to a leak-tight connection by the compression from the combination of its own weight and the fitted seal

11.3.2. Dry-installed

Horizontal

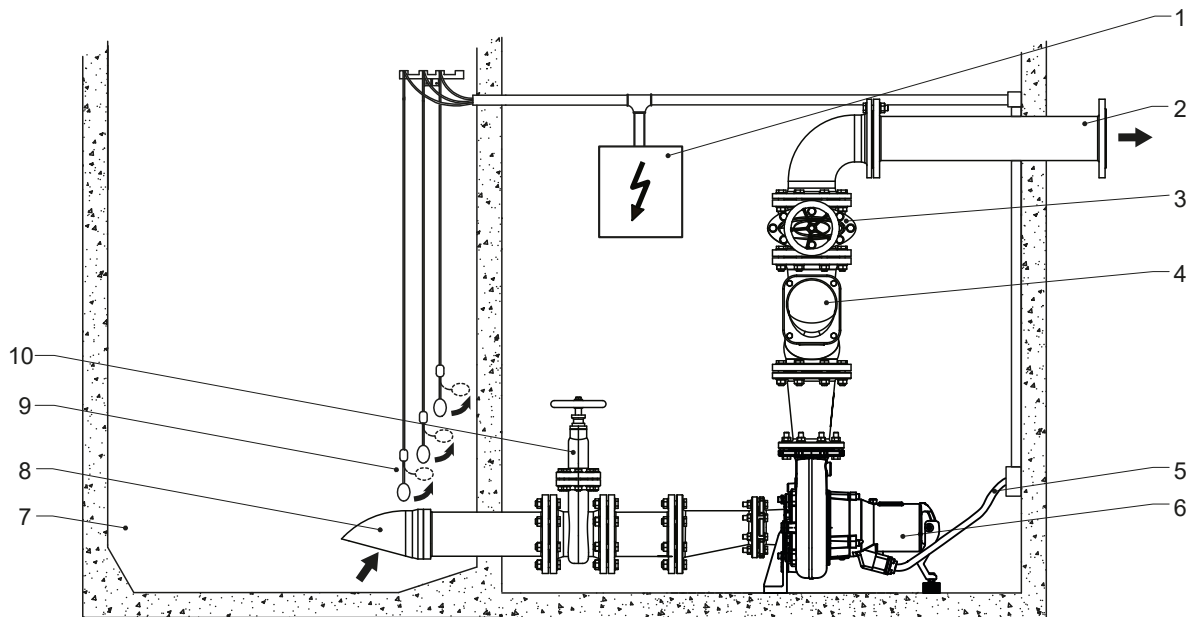

The pump is installed using the Sulzer horizontal support kit as specified for the particular model (assembly leaflet 15975757 is supplied with kit).

Table 7.

AS	Part number
0630, 0830, 0840	62665103
0831, 0841	61825001

Vertical

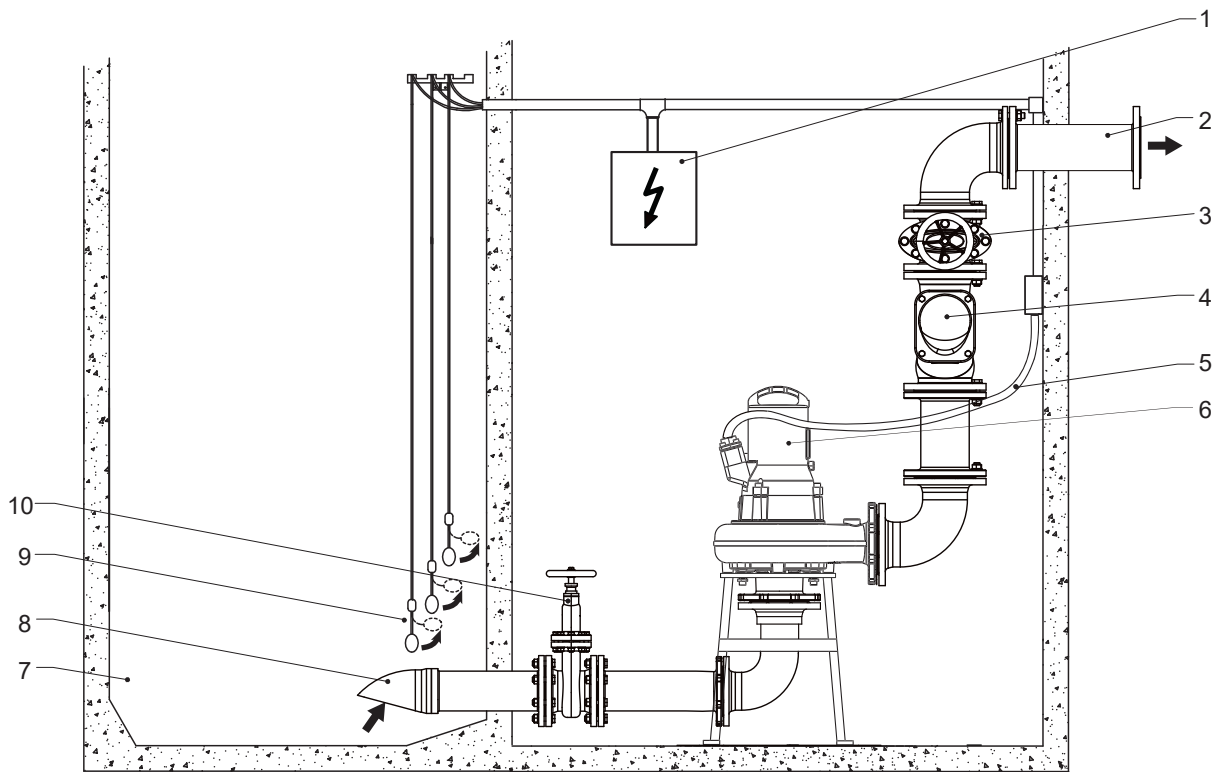

- 1 Control panel
- 2 Discharge line
- 3 Gate valve
- 4 Non-return valve
- 5 Power cable from motor to control panel
- 6 Pump
- 7 Collection sump
- 8 Inflow line
- 9 Ball-type float switch
- 10 Gate valve

Particular attention should be paid to:

- the provision of venting to the sump.
- installation of isolating valves on the inlet and discharge lines.
- removal of any slack from the power cable by coiling and securing it so that it cannot be damaged during operation of the pump.

	ATTENTION
	The power cable should be handled carefully during installation and removal of the pump in order to avoid damage to the insulation.

	WARNING
	Hot surface When dry-installed the pump motor housing may become hot. In such a case, to avoid burn injury, allow to cool down before handling.



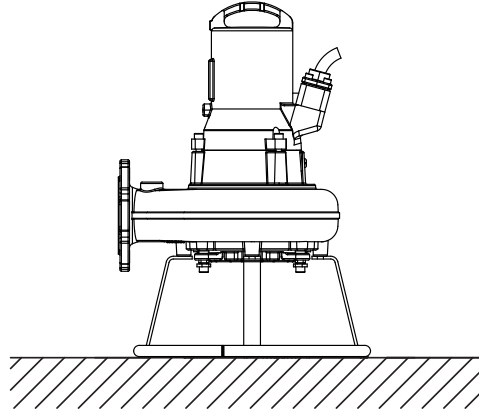

11.3.3. Transportable

About this task



For transportable installation the unit is fitted to a pump stand.

Hoses, pipes and valves must be sized to suit the pump performance.

	 DANGER
	<p>Dangerous voltage Arrange the cable run so that the cables will not be kinked or nipped.</p>
	 DANGER
	<p>Dangerous voltage Submersible pumps used outdoors must be fitted with a power cable of at least 10 meter length. Other regulations may apply in different countries.</p>

Procedure



1. Place the pump on a firm surface which will prevent it from overturning or burrowing down. The pump stand can also be bolted down to the floor surface, or the pump suspended slightly by the lifting hoop.
2. Connect the discharge pipe and cable.

11.3.4. Venting of the volute

After lowering the pump into the sump medium, an air lock may occur in the volute causing pumping problems. To clear the air lock, you can shake the pump and/or raise and lower the pump in the medium, until the resulting air bubbles no longer appear at surface level. If necessary, repeat this venting procedure.

We strongly recommend that dry-installed units are vented back into the sump through the drilled and tapped hole in the volute.



12. Electrical connection

	 DANGER
	<p>Dangerous voltage</p> <p>Before commissioning, an expert should check that one of the necessary electrical protective devices is available. Earthing, neutral, earth leakage circuit breakers, etc. must comply with the regulations of the local electricity supply authority and a qualified person should check that these are in perfect order.</p>

	ATTENTION
	<p>The power supply system on site must comply with local regulations with regard to cross-sectional area and maximum voltage drop. The voltage stated on the nameplate of the pump must correspond to that of the mains.</p>

Suitably rated means of disconnection shall be incorporated in the fixed wiring by the installer for all pumps in accordance with applicable local National codes.

The power supply cable must be protected by an adequately dimensioned slow-blow fuse corresponding to the rated power of the pump.



	 DANGER
	<p>Dangerous voltage</p> <p>The incoming power supply as well as the connection of the pump itself to the terminals on the control panel must comply with the circuit diagram of the control panel as well as the motor connection diagrams and must be carried out by a qualified person.</p>

All relevant safety regulations as well as general good technical practice must be complied with.

Submersible pumps used outdoors must be fitted with a power cable of at least 10 meter length. Other regulations may apply in different countries.

In all installations, the power supply to the pump must be via a residual current device (e.g. RCD, ELCB, RCBO etc.) with a rated residual operating current in accordance with local regulations. For installations not having a fixed residual current device the pump must be plugged into the power supply through a portable version of the device.

All three phase pumps must be installed with motor starting and overload protective devices in the fixed wiring by the installer. Such motor control and protective devices must comply with the requirements of IEC standard 60947-4-1. They must be rated for the motor that they control, and wired and set/adjusted according to the instructions provided by the manufacturer. In addition, the overload protective device that is responsive to the motor current shall be set / adjusted to 125% of the marked rated current.

	 DANGER
	<p>Dangerous voltage</p> <p>Risk of electrical shock. Do not remove cord and strain relief and do not connect conduit to pump.</p>

	NOTE
	<p>Please consult your electrician.</p>

The following components should be incorporated in the fixed wiring for all single phase pumps:

- Motor starting and/or running capacitor that complies with the requirements of IEC 60252-1 and rated as specified in the installation instruction. The capacitor shall be class S2 or S3.
- Motor contactor that complies with the requirements of IEC Standard 60947-4-1 and rated for the motor that it controls.

	 DANGER
	<p>Dangerous voltage This pump has not been investigated for use in swimming pools.</p>

12.1. Seal monitoring

These pumps can be fitted with an optional leakage sensor (DI) to detect and alert to the ingress of water into the motor chamber (non-Ex and Ex), and seal chamber (non-Ex only). Fitted as standard on 60 Hz Ex (FM).

In order to integrate this seal monitoring function into the control panel of the pump it is necessary to fit a Sulzer DI module and connect this in accordance with the circuit diagram below.

Figure 5. Sulzer leakage control type CA 461

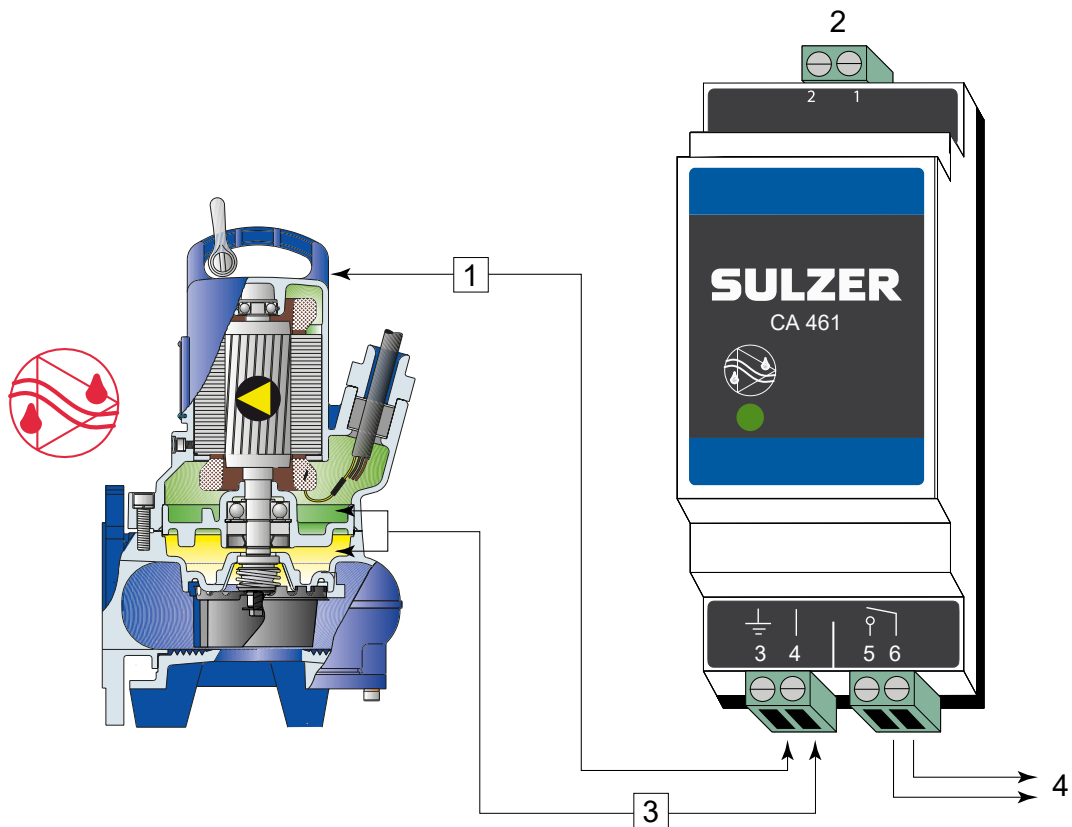

- 1 Connect terminal 3 to ground or housing of the pump.
- 2 Power supply
- 3 Leakage input
- 4 Output

Electronic amplifier

110 - 230 V AC 50/60 Hz (CSA) - Part No.: 16907010. **18 - 36 VDC, SELV** - Part No.: 16907011

Multiple-input leakage control modules are also available. Please consult with your local Sulzer representative.

!	ATTENTION
	Maximum relay contact loading: 2 Ampere

!	ATTENTION
	It is very important to note that with the connection example above it is not possible to identify which sensor/alarm is being activated. As an alternative Sulzer highly recommends to use a separate CA 461 module for each sensor/input, to allow not only identification but also to prompt to the appropriate response to the alarm category/severity.

!	ATTENTION
	If the leakage sensor (DI) is activated the unit must be immediately taken out of service. Please contact your Sulzer service center.

12.2. Temperature monitoring

12.2.1. Temperature sensor bimetal

Figure 6. Curve showing operation principle of bimetallic temperature limiter

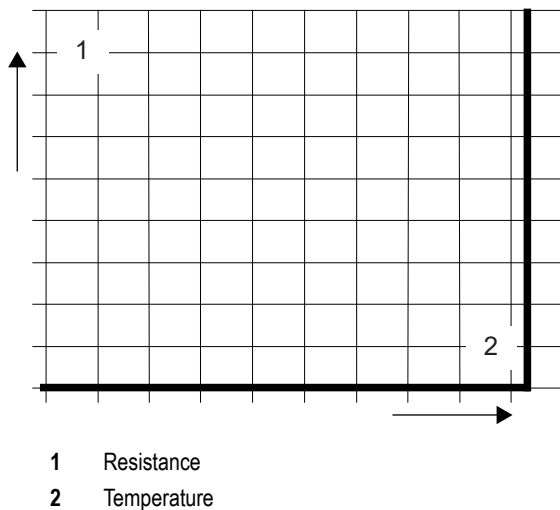

Table 8.

Application	Option
Function	Temperature switch using the bimetallic principle, which opens at a rated temperature
Switching	Taking care not to exceed the allowable switching current, these can be fitted directly into the control circuit

Operating voltage AC

100 V to 500 V ~

Rated voltage AC

250 V

Rated current AC $\cos \varphi = 1,0$

2.5 A

Rated current AC $\cos \varphi = 0,6$

1.6 A

Max. switching current at I_N

5.0 A



ATTENTION

The maximum switching ability of the thermal sensors is 5 A, the rated voltage 250 V. Explosion-proof motors which are connected to static frequency inverters must be fitted with thermistors. Activation must be by means of a thermistor protective relay device with PTB approval number.

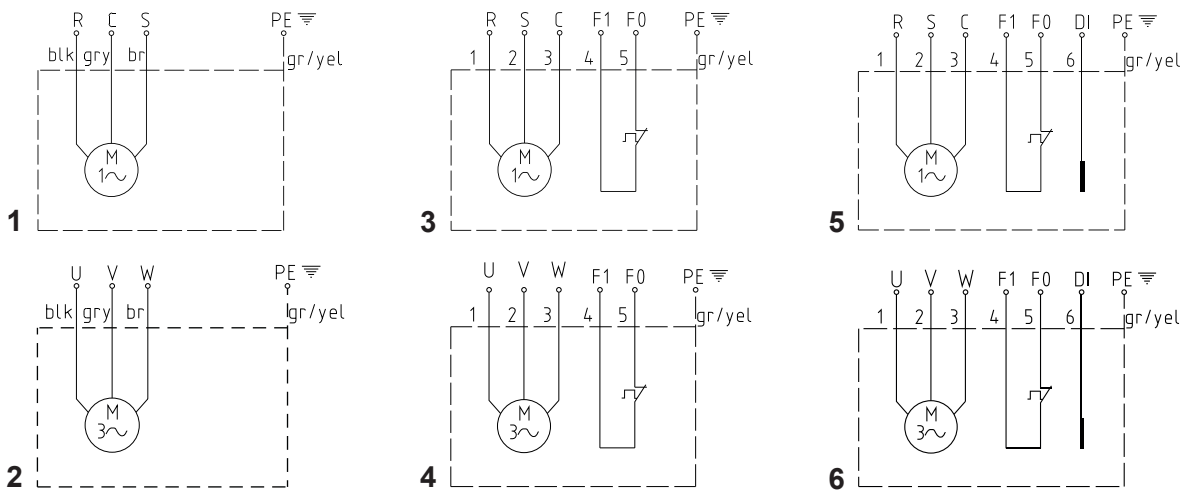

12.3. Wiring diagrams







1. Single phase wiring
2. Three phase wiring
3. Single phase wiring with temperature limiter
4. Three phase wiring with temperature limiter
5. Single phase wiring with temperature limiter and leakage sensor (DI)
6. Three phase wiring with temperature limiter and leakage sensor (DI)

Table 9.

Note:		Note USA:
U,V,W = Live	Di = Leakage sensor	U, V, W = T1, T2, T3
PE = Earth	F1/F0 = Thermal sensor	F1 = 1
gr/yel = Green / yellow	R = Run	F0 = 2
blk = Black	C = Common (Neutral)	Di = 3
gry = Grey	S = Start	
br = Brown		

	 DANGER
	<p>Danger of explosion</p> <p>Explosion-proof pumps may only be used in explosive zones with the thermal sensors connected (leads F0 & F1).</p>
	ATTENTION
	<p>It is important to use the correct capacitors with single phase pumps. Use of incorrect capacitors will lead to motor burn-out.</p>

13. Commissioning

	 CAUTION
	<p>All safety hints in other sections must be observed!</p>
	 DANGER
	<p>Danger of explosion</p> <p>In explosive zones care must be taken that during switching on and operation of the pumps, the pump section is filled with water (dry running) or alternatively is submerged or under water (wet installation). Ensure in this case that the minimum submergence given in the data sheet is observed. Other types of operation e.g. snore operation or dry running are not allowed.</p>

Before commissioning, the pump should be checked and a functional test carried out. Particular attention should be paid to the following:

- Have the electrical connections been carried out in accordance with regulations?
- Have the thermal sensors been connected?
- Is the seal monitoring device correctly installed?
- Is the motor overload switch correctly set?
- Does the unit sit correctly on the pedestal?
- Is the direction of rotation correct - even if run via an emergency generator?
- Are the switching ON and switching OFF levels set correctly?
- Are the level control switches functioning correctly?
- Are the required gate valves (where fitted) open?
- Do the non-return valves (where fitted) function easily?
- Has the volute been vented?
- Have the power and control circuit cables been correctly fitted?
- Was the sump cleaned out?
- Have the inflow and outflows of the pump station been cleaned and checked?
- Have the hydraulics been vented in the case of dry installed units?

Related concepts

[Venting of the volute](#) on page 22

13.1. Types of operation and frequency of starting

AS has been designed for intermittent use only (S3, 25%) when dry-installed, and continuous use (S1) when submerged, but only to the minimum water levels specified below.



Table 10.



AS	0530	0630	0631	0641	0830	0831	0840	0841
Minimum water level (mm)	331	348	346	346	408	445	379	450

13.2. Direction of rotation

13.2.1. Checking direction of rotation

When three phase units are being commissioned for the first time, and also when used on a new site, the direction of rotation must be carefully checked by a qualified person.

	 CAUTION
	<p>The direction of rotation should only be altered by a qualified person.</p> <p>When checking the direction of rotation, the pump should be secured in such a manner that no danger to personnel is caused by the rotating impeller or by the resulting air flow. Do not place your hand into the hydraulic system!</p>

	 CAUTION
	<p>When checking the direction of rotation, or when starting the unit, pay attention to the START REACTION. This can be very powerful and cause the pump to jerk in the opposite direction to the direction of rotation.</p>

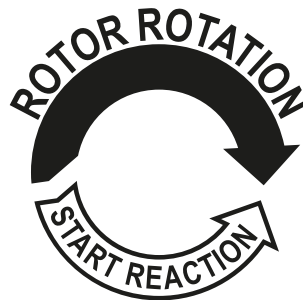



	ATTENTION
	When viewed from above, the direction of rotation is correct if the impeller rotates in a clockwise manner.

	NOTE
	The start reaction is anti-clockwise.



	ATTENTION
	If a number of pumps are connected to a single control panel then each unit must be individually checked.



	ATTENTION
	The mains supply to the control panel should have a clockwise rotation. If the leads are connected in accordance with the circuit diagram and lead designations, the direction of rotation will be correct.



13.2.2. Changing direction of rotation



	 CAUTION
	<p>The direction of rotation should only be altered by a qualified person.</p> <p>If the direction of rotation is incorrect, alter it by changing over two phases of the power supply cable in the control panel. The direction of rotation should then be rechecked.</p>



14. Maintenance and service

	 DANGER
	<p>Dangerous voltage</p> <p>Before commencing any maintenance work the unit should be completely disconnected from the mains by a qualified person and care should be taken that it cannot be inadvertently switched back on.</p>

	 CAUTION
	<p>When carrying out any on-site service or maintenance work i.e. cleaning, venting, fluid inspection or changing, and adjustment of the bottom plate gap, the safety regulations covering work in enclosed areas of sewage installations as well as good general technical practices should be followed.</p>

	 CAUTION
	<p>Repair work must only be carried out by qualified personnel approved by Sulzer.</p>

	 WARNING
	<p>Hot surface</p> <p>Under continuous running conditions the pump motor housing can become very hot. To prevent burn injury allow to cool down before handling.</p>

	 WARNING
	<p>Hot liquid</p> <p>Coolant temperature can reach up to 60 °C under normal operating conditions.</p>

	ATTENTION
	<p>The maintenance instructions given here are not designed for “do-it-yourself” repairs as special technical knowledge is required.</p>

14.1. General maintenance instructions

Sulzer submersible pumps are reliable quality products, each being subjected to careful final inspection. Lubricated-for-life ball bearings, together with monitoring devices, ensure optimum pump reliability provided that the pump has been connected and operated in accordance with the operating instructions. However, should a malfunction occur, do not improvise, but ask your Sulzer Customer Service Department for assistance. This applies particularly if the pump is continually switched off by the current overload in the control panel, by the thermal sensors of the thermo-control system, or by the leakage sensor (DI).

Regular inspection and care is recommended to ensure a long service life. Service intervals vary for Sulzer units depending on installation and application. For recommended service interval details contact your local Sulzer Service Center. A maintenance contract with our Service Department will guarantee the best technical service.

When carrying out repairs, only original spare parts supplied by the manufacturer should be used. Sulzer warranty conditions are only valid provided repair work has been carried out in a Sulzer approved workshop, and original Sulzer spare parts have been used.

!	ATTENTION	
	Repair work on explosion-proof motors may only be carried out in authorized workshops by qualified personnel using original parts supplied by the manufacturer. Otherwise the Ex-approvals are no longer valid. Detailed technical information is available in the technical data sheet which can be downloaded from https://www.sulzer.com	

Motor chamber: The motor chamber should be inspected every 12 months to ensure it is free from moisture.

14.2. Oil filling and changing

The seal chamber between the motor and the hydraulic section has been filled at manufacture with lubricating oil. An oil change is only necessary if a fault occurs.

Oil: white ISO VG8 - VG10

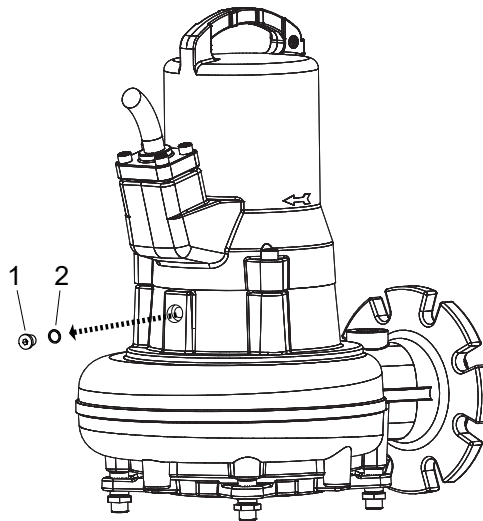

14.3. Oil quantities (liters)

Table 11.

Pump type	Motor		Liter
	50 Hz	60 Hz	
AS 0530	S12/2	S16/2	0.48
AS 0530	S17/2	S18/2	0.48
AS 0530	S26/2	S30/2	0.48
AS 0630	S10/4	S10/4	0.56

table continued

Pump type	Motor		Liter
	50 Hz	60 Hz	
AS 0630	S13/4	S16/4	0.56
AS 0630	S22/4	S25/4	0.56
AS 0631	S12/2	S16/2	0.48
AS 0631	S17/2	S18/2	0.48
AS 0631	S30/2	S35/2	0.48
AS 0641	S30/2	S35/2	0.48
AS 0830	S10/4	S10/4	0.56
AS 0830	S13/4	S16/4	0.56
AS 0830	S22/4	S25/4	0.56
AS 0831	S22/4	S25/4	0.56
AS 0840	S12/2	S16/2	0.43
AS 0840	S17/2	S18/2	0.43
AS 0840	S26/2	S30/2	0.43
AS 0841	S13/4	S16/4	0.56
AS 0841	S22/4	S25/4	0.56

14.4. Bottom plate adjustment (Contrablock)

At manufacture, the Contrablock bottom plate is fitted to the volute with the correct clearance gap set between the impeller and the bottom plate (for optimum performance max 0.2 mm).

14.5. Re-setting the clearance gap following wear

14.5.1. AS 0641 and 0840

About this task

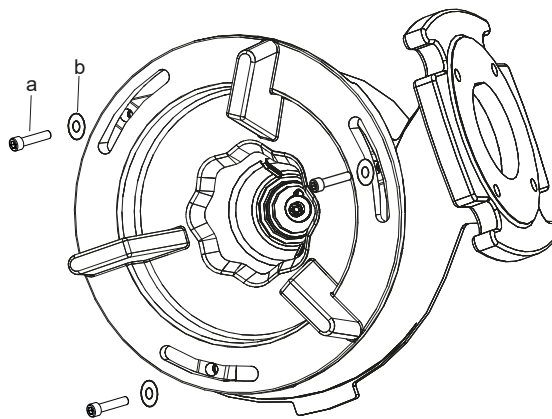

Procedure

1. Loosen the three securing screws (a) and washers (b).
2. Rotate the bottom plate anti-clockwise to lower it until there is contact with the impeller.
3. Rotate the bottom plate clockwise until there is 0.3 mm to 0.5 mm clearance between it and the impeller.
4. Tighten the securing screws to 17 Nm.
5. Check that the impeller rotates freely.

14.5.2. AS 0831 and 0841

About this task

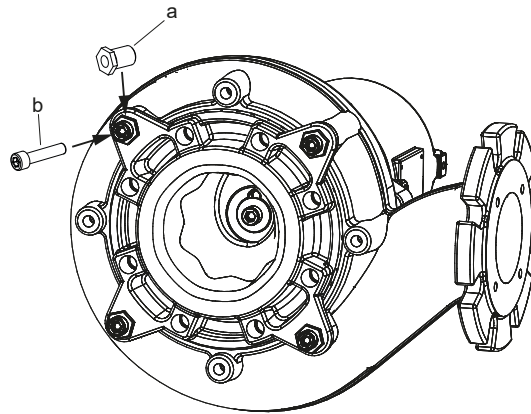

Procedure

1. Loosen the four securing screws (b).
2. Rotate the four adjusting screws (a) anti-clockwise until there is contact between the bottom plate and the impeller.
3. Rotate the adjusting screws clockwise until there is 0.3 mm to 0.5 mm clearance between the bottom plate and the impeller.
4. Tighten the securing screws to 33 Nm.
5. Check that the impeller rotates freely.

14.6. Bearings and mechanical seals

These pumps are fitted with lubricated-for-life ball bearings. Shaft sealing between the motor and hydraulic section is by means of a mechanical seal (Sic/Sic). Seal at the motor side is by an oil lubricated lip seal.

	ATTENTION
	Once removed, bearings and seals must not be re-used, and must be replaced in an approved workshop with genuine Sulzer spare parts.



14.7. Changing the power cable

	⚠ DANGER
	Dangerous voltage The power cable must be replaced by the manufacturer, its service agent or a similar qualified person, in strict adherence to relevant safety regulations.

14.8. Clearing pump blockage

14.8.1. Instructions for operator



The operator should only attempt to unblock the pump by re-setting the overload reset button or MCB on the control panel. The initial start force may be enough to displace any clogged material. If the pump continues to trip out on restart then a qualified service agent must be called.



	 DANGER
	<p>Dangerous voltage</p> <p>To carry out the procedure above safely the control panel must not need to be opened to do so. The overload reset button or MCB must therefore be an externally mounted design.</p>

14.8.2. Instructions for service personnel

About this task

	 DANGER
	<p>Dangerous voltage</p> <p>The pump must be isolated from the power supply before removing it from the installation</p>

	 CAUTION
	<p>Adequate personal protective equipment must be worn at all times.</p>

	 CAUTION
	<p>Lifting safety regulations must be adhered to when lifting the pump.</p>

Procedure

1. Ensure that the pump is secured so that it cannot topple or roll over.
2. Use pump pliers to check for rags etc in the volute inlet and discharge, and try to turn the impeller by hand to check if there is anything jammed behind it.

	ATTENTION
	<p>Never use fingers, even in gloves, to check around the volute internally due to the danger of something sharp piercing the gloves and skin.</p>

3. Remove the bottom plate and clear out any debris with a pliers.
4. If the impeller is still jammed from behind then the impeller has to be removed.
5. The impeller and bottom plate should be checked for impact and wear damage.
6. Once the debris has been cleared out the impeller is refitted and should rotate freely by hand.

7. Refit the bottom plate

	ATTENTION
	The gap between the bottom plate must be checked and adjusted if necessary. This is important as a measure to help prevent future blockages.

8. Reconnect the pump to the power source and dry run to check audibly for bearing or other mechanical damage.

	ATTENTION
	Secure the pump so it cannot roll or fall on starting, and do not stand near the pump or directly in front of the pump discharge.

Related concepts

[Personal protective equipment](#) on page 7

[Lifting](#) on page 14

[Bottom plate adjustment \(Contrablock\)](#) on page 31

14.9. Cleaning

If the pump is used for transportable applications, then in order to avoid deposits of dirt and encrustation it should be cleaned after each usage by pumping clear water. In the case of fixed installation, we recommend that the functioning of the automatic level control system be checked regularly. By switching the selection switch (switch setting “HAND”) the sump will be emptied. If deposits of dirt are visible on the floats then these should be cleaned. After cleaning, the pump should be rinsed out with clear water and a number of automatic pumping cycles carried out.

15. Troubleshooting guide



Table 12.

Fault	Cause	Fix
Pump does not run	Leakage sensor shutdown	Check for loose or damaged oil plug, or locate and replace faulty mechanical seal / damaged o-rings. Change oil. ¹⁾
	Air lock in volute	Shake or raise and lower the pump repeatedly until resulting air bubbles no longer appear at surface level.
	Level control override	Check for float switch that is faulty or tangled and held in OFF position in sump.
	Impeller jammed.	Inspect and remove jammed object. Check gap between impeller and bottom plate and adjust if necessary.
	Gate valve closed, non-return valve blocked.	Open gate valve, clean blockage from non-return valve.
Pump switching on/off intermittently	Temperature sensor shutdown.	Motor will restart automatically when pump cools down. Check thermal relay settings in control panel. Check for impeller blockage. If none of above, a service inspection is required. ¹⁾

table continued

Fault	Cause	Fix
Low head or flow	Wrong direction of rotation.	Change rotation by interchanging two phases of the power supply cable.
	Gap too wide between impeller and bottom plate	Reduce gap.
	Gate valve partially open.	Open valve fully.
Excessive noise or vibration	Defective bearing.	Replace bearing. ¹⁾
	Clogged impeller.	Clear the pump blockage to remove and clean hydraulics.
	Wrong direction of rotation.	Change rotation by interchanging two phases of the power supply cable.

¹⁾Pump must be taken to approved workshop.

	 CAUTION
	<p>Before commencing any inspection or repair work the pump should be completely disconnected from the mains by a qualified person and care should be taken that it cannot be inadvertently switched back on.</p>

Related concepts

[Bottom plate adjustment \(Conrablock\)](#) on page 31

16. Company details

Address: Sulzer Pump Solutions Ireland Ltd. Clonard Road, Wexford, Ireland

Telephone: +353 53 91 63 200

Website: www.sulzer.com