

SULZER

Water and wastewater solutions

Submersible dewatering pumps

In the real world time is money, and worksites have no time for unwanted water. Sulzer has the solutions in a complete pump range for reliable dewatering. sulzer.com/dewatering





Dewatering solutions for the real world

Sulzer's submersible dewatering pumps are the result of more than 50 years of technical and real-world experience. Each pump type is presented with its key features, as well as dimensions, performance curves and the most important technical data for specific pump models.

Whether you work in mining, tunneling or construction, the pumps here are your best insurance against water-related downtime. From purchasing to service, you can turn to us for dewatering solutions that make a difference in the real world.

Performance range 60 Hz

Sulzer's complete range of submersible dewatering pumps provides reliable solutions for all major dewatering needs.

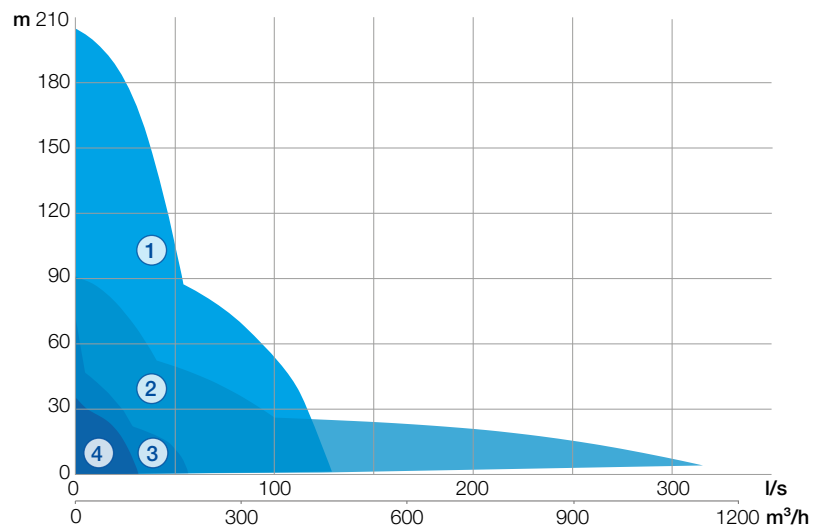

- ① XJ 900
- ② J 205 - J 604
- ③ J 12 - J 15, JC 34, XJ 25 - XJ 110, XJC 50 - XJC 110
- ④ JS 4 - JS 8, JS 12 - JS 15, XJS 25 - XJS 110

Submersible drainage pump J

Submersible drainage pump J is suitable for pumping water and dirty water mixed with light abrasives. The low weight and compact design makes for convenient transport, handling and installation.

1 Easy start

A built-in contactor connected to the thermal sensors in the stator windings protects the motor from overheating and features an automatic restart function.

2 Wear resistance

An impeller in white cast iron with a full upper shroud and adjustable wear parts coated in nitrile rubber ensure high abrasion resistance.

3 Reliable operation

A double mechanical shaft seal in an oil bath, with primary and secondary seal surfaces in silicon carbide, extends the life of the pump. A double outer casing and good heat convection enable the pump to operate continuously at low levels – or even run dry without damaging the motor.

4 Serviceability

Due to the modular design, the same parts can be used for different pumps, which lowers the overall service costs. An adjustable diffuser ensures proper clearance throughout the impeller lifetime. By removing the top cover of the pump, the electrical junction area can easily be checked.



Submersible drainage pump J 12

J 12 W/J 12 WKS*	1-phase	3-phase
J 12 D/J 12 DKS**		
Motor rating P2	1.1 kW, 1~ (1.5 hp)	1.1 kW, 3~ (1.5 hp)
Voltage (V)	115 / 230	230 / 380 / 460 / 575
Full load (A)	13.8 / 6.9	4.3 / 2.6 / 2.1 / 1.7
Speed	3360 rpm	3380 rpm
Strainer hole	6.5 x 22 mm	
Discharge connections	Hose 1½", 2", 2½", 3" Thread G/BSP 2", 2½", 3"	
Weight (excl. cable)	19 kg (W), 18 kg (D)	
Motor protection	Built-in	
Electric cable	20 m	

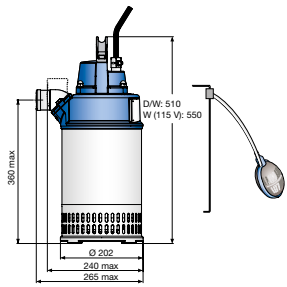
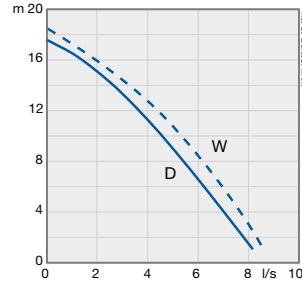

Submersible drainage pump J 15

J 15 W/J 15 WKS*	1-phase	3-phase
J 15 D/J 15 DKS**		
Motor rating P2	1.5 kW, 1~ (2.0 hp)	1.7 kW, 3~ (2.3 hp)
Voltage (V)	230	230 / 380 / 460 / 575
Full load (A)	10.3	6.2 / 3.8 / 3.1 / 2.5
Speed	3420 rpm	3320 rpm
Strainer hole	6.5 x 22 mm	
Discharge connections	Hose 1½", 2", 2½", 3" Thread G/BSP 2", 2½", 3"	
Weight (excl. cable)	21 kg (W), 19 kg (D)	
Motor protection	Built-in	
Electric cable	20 m	

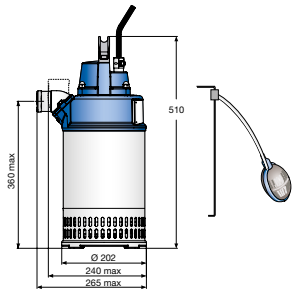
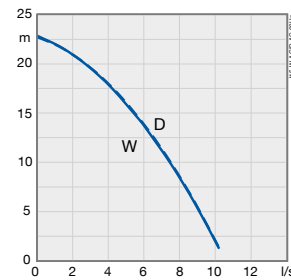

* Built-in float switch available as option.

** KS version not available in 575 V.



Submersible drainage pump XJ

Submersible drainage pump XJ is excellent for pumping water and dirty water mixed with light abrasives. The slim design makes the pump easy to move and easy to handle.

1 Easy and fail-safe starting

Instead of a built-in contactor, an optional AquaTronic unit can be used. The AquaTronic unit compensates for incorrect phase order, which ensures correct motor rotation every time. (Additional AquaTronic functions for electronic supervision are explained on pages 18-21.)

2 Wear resistance

An impeller and wear ring in white cast iron, as well as diffusers coated in oil-resistant nitrile rubber, provide high abrasion resistance.

3 Reliable operation

Double mechanical shaft seals in an oil bath, with primary seal surfaces in silicon carbide and secondary seal surfaces in silicon carbide on carbon, extend the life of the pump. A double cable-entry seal system increases the protection against moisture entering the electrical junction area. A double outer casing and good heat convection enable the pump to operate continuously at low levels – or even run dry without damaging the motor.

4 Serviceability

Due to the modular design, the same parts can be used for different pumps, which lowers the overall service costs. The adjustable wear ring ensures proper clearance throughout the impeller lifetime. External inspection ports for the oil and motor chambers enable quick and easy evaluation of the shaft seal during service. By removing the top cover of the pump, the electrical junction area can easily be checked.

5 Less energy and environmental impact

The high-efficiency motor and new hydraulics combine with low-friction bearings to reduce power losses. The result is low total energy costs and minimized carbon footprint.

6 Flexibility

Conversion between high-volume and high-head hydraulics is managed with only a few parts, ensuring the right performance for the application.

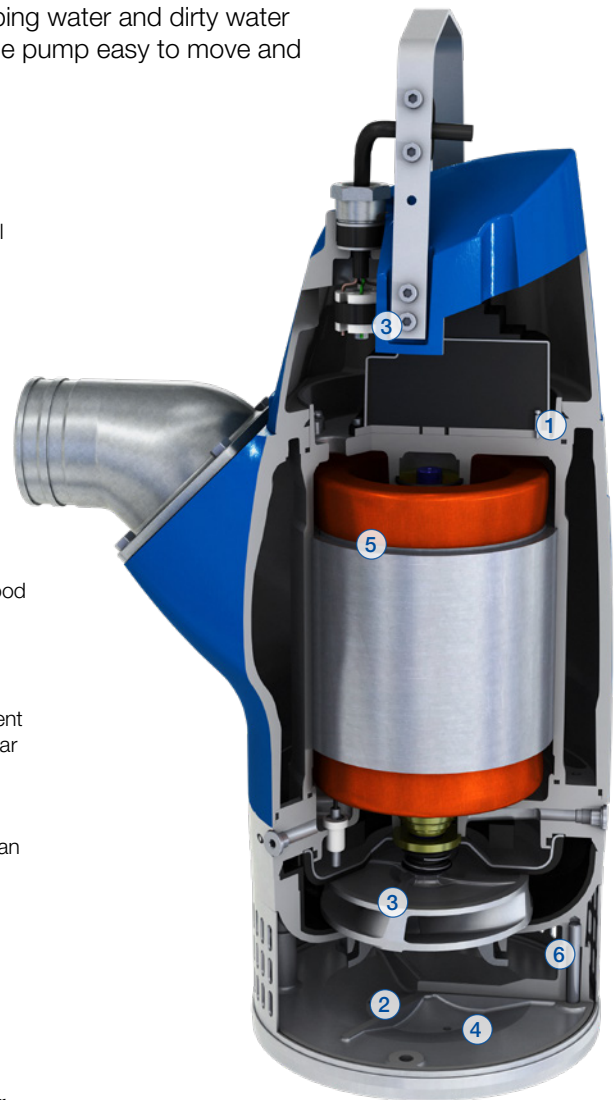

Submersible drainage pump XJ 25

XJ 25 ND*

XJ 25 HD*

Motor rating P2

Voltage (V)

Full load (A)

Speed

Strainer hole

Discharge connections

Weight (excl. cable)

Motor protection

Electric cable

Medium head

High head

2.9 kW, 3~ (4 hp)

230 / 380 / 460 / 575

9.8 / 5.9 / 4.9 / 3.9

3500 rpm

7.5 x 22 mm

Hose 2½", 3", 4"

Thread G/BSP 2½", 3", 4"

39 kg

Built-in

20 m

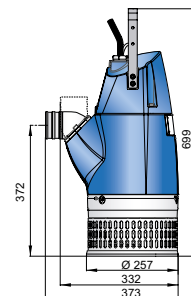
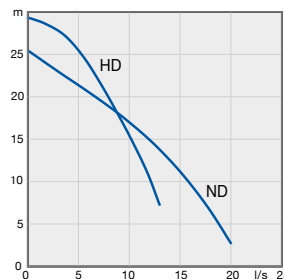

Submersible drainage pump XJ 40

XJ 40 ND*	Medium head
XJ 40 HD*	High head
Motor rating P2	4.3 kW, 3~ (6 hp)
Voltage (V)	230 / 380 / 460 / 575
Full load (A)	14.8 / 8.9 / 7.4 / 5.9
Speed	3470 rpm
Strainer hole	7.5 x 22 mm
Discharge connections	Hose 2½", 3", 4" Thread G/BSP 2½", 3", 4"
Weight (excl. cable)	42 kg
Motor protection	Built-in
Electric cable	20 m

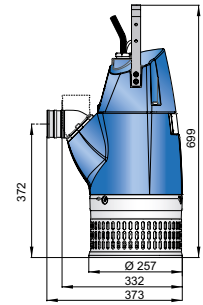
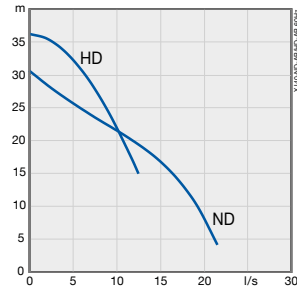

Submersible drainage pump XJ 50

XJ 50 ND*	Medium head
XJ 50 LD*	High flow
XJ 50 HD*	High head
Motor rating P2	6.7 kW, 3~ (9 hp)
Voltage (V)	230 / 380 / 460 / 575
Full load (A)	22.4 / 13.6 / 11.2 / 9.0
Speed	3520 rpm
Strainer hole	7.5 x 22 mm
Discharge connections	Hose 3", 4", 6" Thread G/BSP 3", 4", 6"
Weight (excl. cable)	59 kg
Motor protection	Built-in
Electric cable	20 m

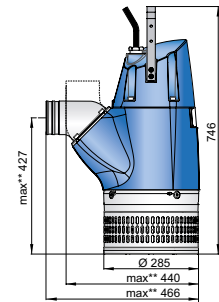
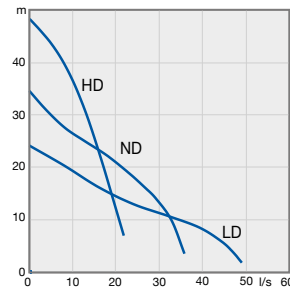

Submersible drainage pump XJ 80

XJ 80 ND*	Medium head
XJ 80 LD*	High flow
XJ 80 HD*	High head
XJ 80 SD*	High head
Motor rating P2	9.8 kW, 3~ (13 hp)
Voltage (V)	230 / 380 / 460 / 575
Full load (A)	31.4 / 19.0 / 15.7 / 12.6
Speed	3520 rpm
Strainer hole	7.5 x 22 mm
Discharge connections	Hose 3", 4", 6" Thread G/BSP 3", 4", 6"
Weight (excl. cable)	63 kg (ND/LD/HD), 78 kg (SD)
Motor protection	Built-in
Electric cable	20 m

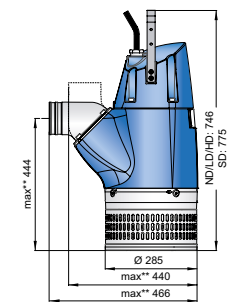
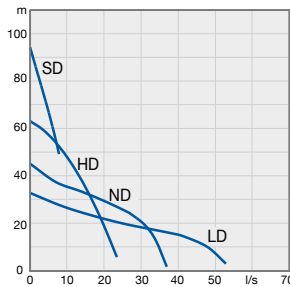

Submersible drainage pump XJ 110

XJ 110 ND*	Medium head
XJ 110 HD*	High head
Motor rating P2	13.5 kW, 3~ (18 hp)
Voltage (V)	230 / 380 / 460 / 575
Full load (A)	42.8 / 25.9 / 21.4 / 17.1
Speed	3500 rpm
Strainer hole	7.5 x 22 mm
Discharge connections	Hose 3", 4", 6" Thread G/BSP 3", 4", 6"
Weight (excl. cable)	81 kg
Motor protection	Built-in
Electric cable	20 m

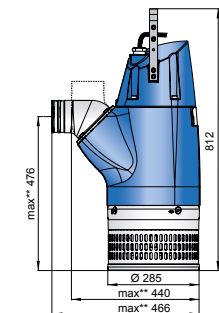
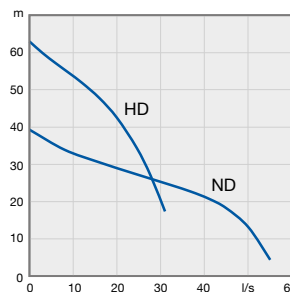

* Option: AquaTronic, built-in electronic pump control.

** Max measurement based on largest discharge size.

Submersible drainage pump J

Submersible drainage pump J is suitable for pumping water and dirty water mixed with light abrasives. The pump design enables convenient transport, handling and installation.

1 Easy to start

Pump J 205 has a built-in contactor connected to the thermal sensors in the stator windings, which protects the motor from overheating and features an automatic restart function. Pumps J 405 and J 604 have thermal sensors in the stator windings that protect the motor from overheating by means of an external control panel.

2 Wear resistance

Abrasive-resistant impellers, combined with diffusers and wear rings coated in oil-resistant nitrile rubber, provide extended pump life in tough applications.

3 Reliable operation

Double mechanical shaft seals in an oil bath, with primary seal surfaces in silicon carbide, extend the life of the pump. In pumps J 205 and J 405, the primary and secondary seals comprise an easy-to-replace seal cartridge. A double outer casing and good heat convection enable the pump to operate continuously at low levels – or even run dry without damaging the motor.

4 Serviceability

External inspection ports for the oil and motor chambers enable quick and easy evaluation of the shaft seal during service. By removing the top cover of the pump, the electrical junction area can easily be checked. The adjustable wear ring ensures proper clearance throughout the impeller lifetime.

5 Flexibility

Conversion between high-volume and high-head hydraulics is managed with only a few parts, ensuring the right performance for the application.

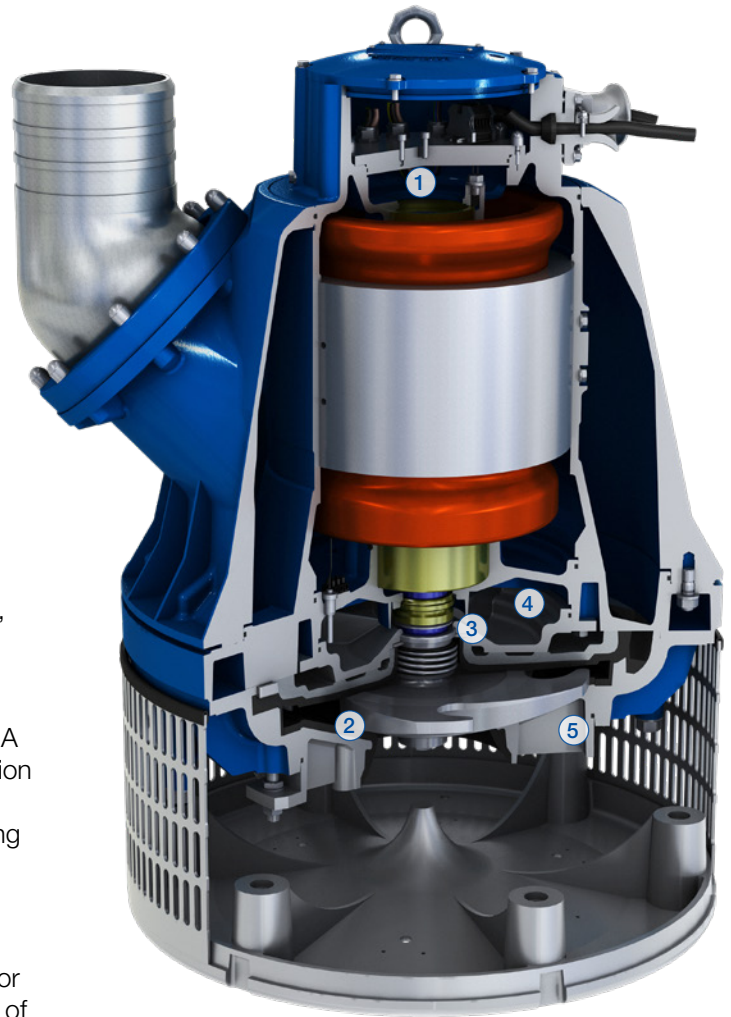

Submersible drainage pump J 205

J 205 ND	Medium head
J 205 HD	High head
Motor rating P2	26 kW, 3~ (35 hp)
Voltage (V)	230 / 380 / 460 / 575
Full load (A)	82 / 50 / 41 / 33
Speed	3'500 rpm
Strainer hole	8 x 34 mm
Discharge connections	Hose 4", 6", 8" Thread G/BSP 4", 6", 8"
Weight (excl. cable)	155 kg
Motor protection	Built-in
Electric cable	20 m

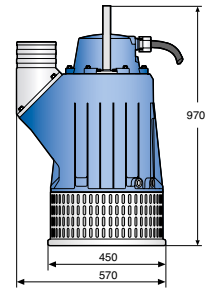
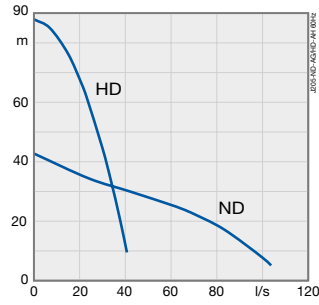

Submersible drainage pump J 405

J 405 ND	Medium head
J 405 HD	High head
Motor rating P2	43 kW, 3~ (57 hp)
Voltage (V)	230 / 380 / 460 / 575
Full load (A)	136 / 82 / 68 / 54
Speed	3'537 rpm
Strainer hole	8 x 34 mm
Discharge connections	Hose 4", 6", 8" Thread G/BSP 4", 6", 8"
Weight (excl. cable)	270 kg
Motor protection	Thermal overload sensors
Electric cable	20 m

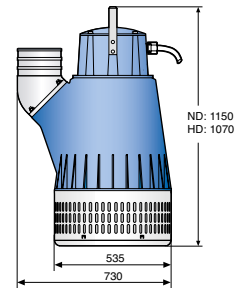
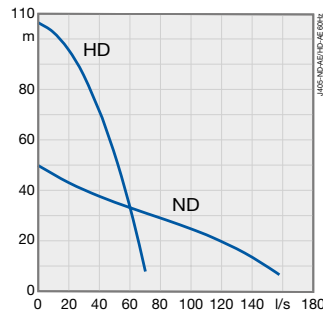

Submersible drainage pump J 604

J 604 ND	Medium head
J 604 HD	High head
Motor rating P2	70 kW, 3~ (94 hp)
Voltage (V)	230 / 380 / 460 / 575
Full load (A)	226 / 137 / 113 / 91
Speed	1'730 rpm
Strainer hole	12 x 60 mm
Discharge connections	Hose 6", 8", 10" Thread G/BSP 6", 8"
Weight (excl. cable)	525 kg
Motor protection	Thermal overload sensors
Electric cable	20 m

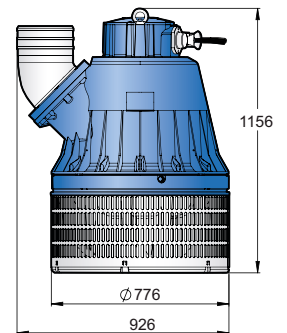
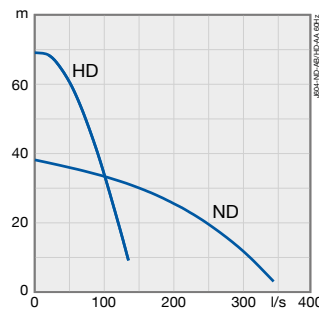

Submersible drainage pump XJ 900

Submersible drainage pump XJ is designed for difficult application environments with abrasives and small solids. The innovative design allows for easy conversion from high head to high flow.

1 Easy conversion from ND to HD

The pump is fitted with impellers and diffusers for both HD and ND versions. When connected in series they give high head and when connected in parallel they give high volume. This gives fewer parts and a simplified conversion from ND to HD.

2 Wear resistance for long life

Impellers and flow elbows in white cast iron together with rubber coated volutes ensure a long lifetime and high efficiency. The impellers are built back to back together with double exit volutes which gives low axial forces and secures long bearing life.

3 Reliable operation

Strong cast iron construction with outer casing gives good cooling and enables the pump to run all the way until the water level reaches the strainer. Double mechanical seals with silicon carbide surface give extended service life.

4 Built-in motor protection

Bimetal thermal switches or Pt100 sensors in stator windings are used to protect the motor from overheating. Moisture sensors are used in the oil chamber, the motor chamber and in the connection chamber to signal the ingress of moisture into the motor. An additional monitoring option for Pt100 sensors in bearings for temperature measurement provides an added level of protection.

5 Serviceability

External inspection ports for the oil and the motor chambers enable quick and easy evaluation of the shaft seal during service. The electrical installation can be easily checked by removing the inspection cover of the pump.



6 Reduced environmental impact

The high-efficiency IE3 motor and the new hydraulics combined with low-friction bearings reduce power losses and extend stator life. The result is low total energy costs and minimized carbon footprint.

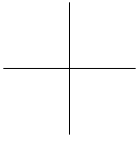

State of the art design

The innovative design with dual impellers allows for a quick and simple conversion between hydraulic performance options, reducing the need to addition inventory to cover the range. Both high head and high flow versions use the same two impellers.

In the HD version, the water circulates from the first impeller to the second impeller, connecting the impellers in series, creating higher pressure.

For the ND version, the impellers are connected in parallel. The water flows into both impellers simultaneously, creating higher flow.

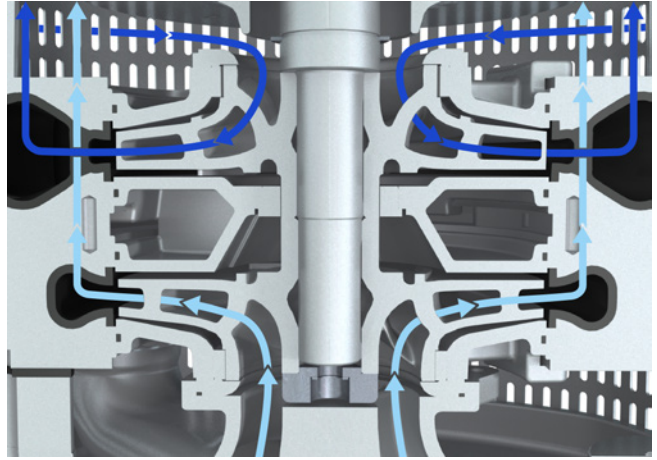

XJ 900 ND

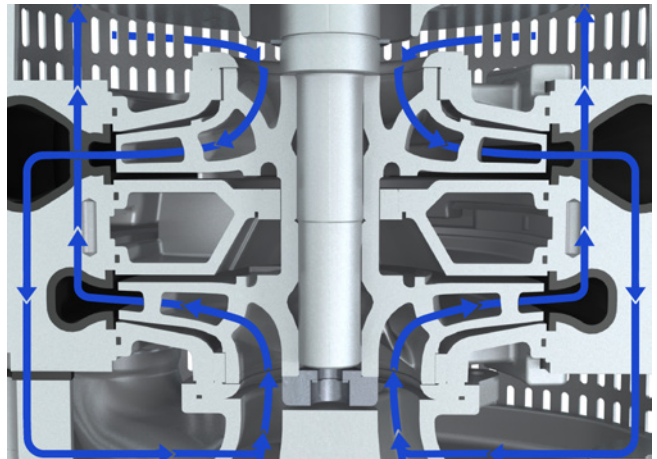

XJ 900 HD

Submersible drainage pump XJ 900

XJ 900 ND	High flow
XJ 900 HD	High head
Motor rating P2	108 kW, 3~ (145 Hp)
Voltage (V)	380 / 480 / 575
Full load (A)	190 / 154 / 124
Speed	3560 rpm
Strainer hole	8 x 34 mm
Discharge connections	DN100/4" (standard HD) DN150/6" (standard ND)
Flanged connections	Class 250 (standard HD) Class 150 (standard ND)
Weight (excl. cable)	1200 kg
Motor protection	Built-in
Electric cable	20 m (longer cable on request)

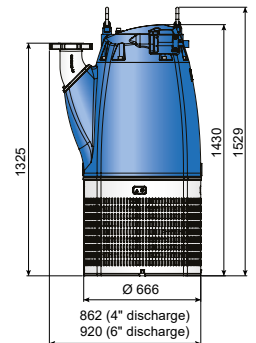
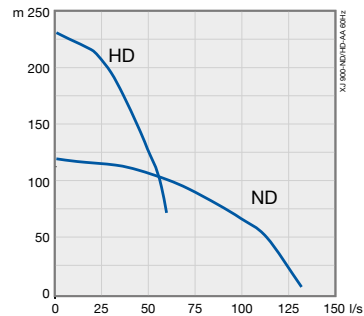

Submersible drainage center-line pumps JC and XJC

Submersible drainage center-line pumps JC and XJC are excellent for pumping water and dirty water mixed with light abrasives. The slim design makes them easy to move and easy to handle, and they are perfect for applications with limited installation space.

1 Easy and fail-safe starting

In XJC pump models, an optional AquaTronic unit can be used instead of a built-in contactor. The AquaTronic unit compensates for incorrect phase order, which ensures correct motor rotation every time. (Additional AquaTronic functions for electronic supervision are explained on pages 18-21.) In JC pump models, a built-in contactor with an automatic restart function protects the motor.

2 Wear resistance

An impeller and wear ring in white cast iron, as well as diffusers coated in oil-resistant nitrile rubber, provide high abrasion resistance.

3 Reliable operation

Double mechanical shaft seals in an oil bath, with primary seal surfaces in silicon carbide and secondary seal surfaces in silicon carbide on carbon, extend the life of the pump. Pumps XJC 50 - XJC 110 have a double cable-entry seal system that increases the protection against moisture entering the electrical junction area. A double outer casing and good heat convection enable the pump to operate continuously at low levels – or even run dry without damaging the motor.

4 Serviceability

Due to the modular design, the same parts can be used for different pumps, which lowers the overall service costs. The adjustable wear ring ensures proper clearance throughout the impeller lifetime. External inspection ports for the oil and motor chambers enable quick and easy evaluation of the shaft seal during service. By removing the top cover of the pump, the electrical junction area can easily be checked.

5 Less energy and environmental impact

Pumps XJC 50 - XJC 110 are equipped with high-efficiency motors and new hydraulics, which combine with low-friction bearings to reduce power losses. The result is low total energy costs and minimized carbon footprint.

6 Flexibility

Pumps XJC 50 - XJC 110 allow conversion between high-volume and high-head hydraulics with only a few parts, ensuring the right performance for the application.



Submersible drainage center-line pump JC 34

JC 34 ND	Medium head
JC 34 HD	High head
Motor rating P2	4.3 kW, 3~ (6 hp)
Voltage (V)	230 / 460 / 575
Full load (A)	16 / 8 / 6,4
Speed	3400 rpm
Strainer hole	8 x 33 mm
Discharge connections	Hose 2", 3" Thread G/BSP 2", 3"
Weight (excl. cable)	31 kg
Motor protection	Built-in
Electric cable	20 m

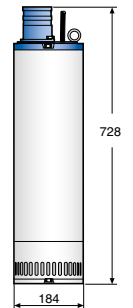
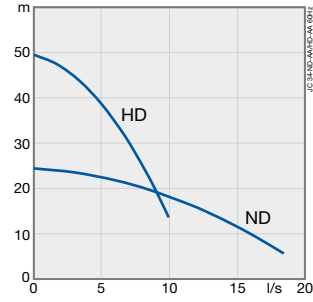

Submersible drainage center-line pump XJC 50

XJC 50 ND*	Medium head
XJC 50 LD*	High flow
XJC 50 HD*	High head
Motor rating P2	6.7 kW, 3~ (9 hp)
Voltage (V)	230 / 380 / 460 / 575
Full load (A)	22.4 / 13.6 / 11.2 / 9.0
Speed	3520 rpm
Strainer hole	7.5 x 22 mm
Discharge connections	Hose 3", 4", 6" Thread G/BSP 3", 4", 6"
Weight (excl. cable)	59 kg
Motor protection	Built-in
Electric cable	20 m

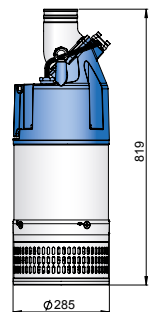
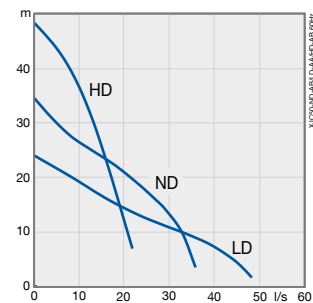

Submersible drainage center-line pump XJC 80

XJC 80 ND*	Medium head
XJC 80 LD*	High flow
XJC 80 HD*	High head
XJC 80 SD*	High head
Motor rating P2	9.8 kW, 3~ (13 hp)
Voltage (V)	230 / 380 / 460 / 575
Full load (A)	31.4 / 19.0 / 15.7 / 12.6
Speed	3520 rpm
Strainer hole	7.5 x 22 mm
Discharge connections	Hose 3", 4", 6" Thread G/BSP 3", 4", 6"
Weight (excl. cable)	63 kg (ND/LD/HD), 78 kg (SD)
Motor protection	Built-in
Electric cable	20 m

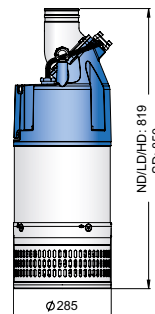
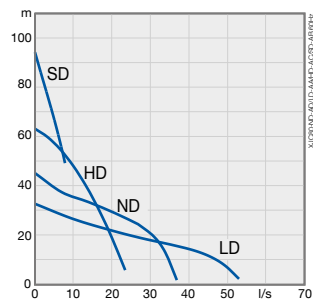

Submersible drainage center-line pump XJC 110

XJC 110 ND*	Medium head
XJC 110 HD*	High head
Motor rating P2	13.5 kW, 3~ (18 hp)
Voltage (V)	230 / 380 / 460 / 575
Full load (A)	42.8 / 25.9 / 21.4 / 17.1
Speed	3500 rpm
Strainer hole	7.5 x 22 mm
Discharge connections	Hose 3", 4", 6" Thread G/BSP 3", 4", 6"
Weight (excl. cable)	80 kg
Motor protection	Built-in
Electric cable	20 m

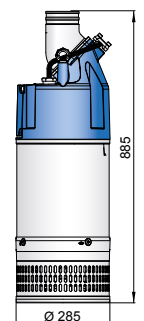
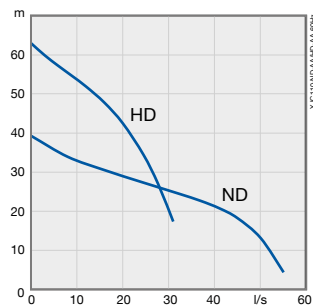

* Option: AquaTronic, built-in electronic pump control.

Submersible sludge pump JS

Submersible sludge pump JS is excellent for pumping dirty water and water mixed with solids. The pump has a slim design and low weight, which makes it easy to move and easy to handle.

1 Easy to start

A built-in contactor connected to the thermal sensors in the stator windings protects the motor from overheating and features an automatic restart function.

2 Clog-free pumping

A free-flow vortex impeller and pump volute make the pump ideal for pumping solids. The impeller is available in different sizes to meet specific requirements.

3 Reliable operation

Both the impeller and volute are made from heavy-duty ductile iron for maximum durability. Double mechanical shaft seals in an oil bath, with primary and secondary seal surfaces in silicon carbide, extend the life of the pump.

4 Convenient handling

The top cover and motor housing are made of lightweight aluminum, which creates a pump that is very easy to handle and install.

5 Serviceability

Due to the modular design, the same parts can be used for different pumps, which lowers the overall service costs. External inspection ports for the oil and motor chambers enable quick and easy evaluation of the shaft seal during service. By removing the top cover of the pump, the electrical junction area can easily be checked.



Submersible sludge pump JS 12

JS 12 W/WKS*	-95	1-phase	
JS 12 W/WKS*	-104	1-phase	
JS 12 D/DKS*	-95		3-phase
JS 12 D/DKS*	-104		3-phase
Motor rating P2		1.1 kW, 1~ (1.5 hp)	1.1 kW, 3~ (1.5 hp)
Voltage (V)		230	230 / 380 / 460 / 575
Full load (A)		6.9	4.3 / 2.6 / 2.1 / 1.7
Speed		3360 rpm	3380 rpm
Free passage		Ø 40 mm	
Discharge connections		Hose 2", 2½", 3"	
		Thread G/BSP 2", 2½", 3"	
Weight (excl. cable)		20 kg (W), 19 kg (D)	
Motor protection		Built-in	
Electric cable		20 m	

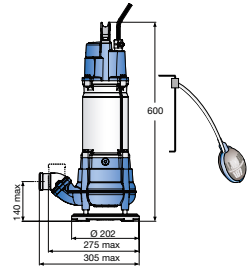
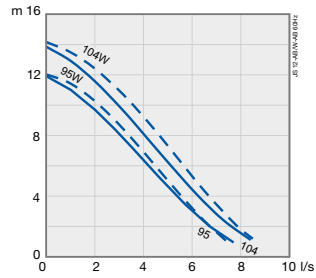

Submersible sludge pump JS 15

JS 15D/DKS* -114		3-phase	
JS 15D/DKS* -126		3-phase	
Motor rating P2		1.7 kW, 3~ (2.3 hp)	
Voltage (V)		230 / 380 / 460 / 575	
Full load (A)		6.2 / 3.8 / 3.1 / 2.5	
Speed		3320 rpm	
Free passage		Ø 40 mm	
Discharge connections		Hose 2", 2½", 3"	
		Thread G/BSP 2", 2½", 3"	
Weight (excl. cable)		20 kg	
Motor protection		Built-in	
Electric cable		20 m	

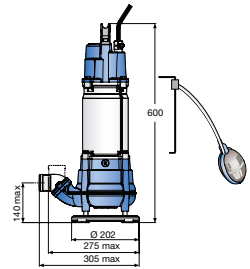
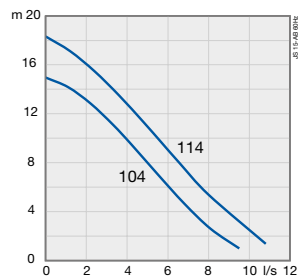

* Built-in float switch available as option. KS version not available in 575 V.



Submersible sludge pump XJS

Submersible sludge pump XJS is excellent for pumping dirty water and water mixed with solids. The slim design makes the pump easy to move and easy to handle.

1 Easy and fail-safe starting

Instead of a built-in contactor, an optional AquaTronic unit can be used. The AquaTronic unit compensates for incorrect phase order, which ensures correct motor rotation every time. (Additional AquaTronic functions for electronic supervision are explained on pages 18-21.)

2 Clog-free pumping

A free-flow vortex impeller and pump volute make the pump ideal for pumping solids. The impeller is available in different sizes to meet specific requirements.

3 Reliable operation

Both the impeller and volute are made from heavy-duty ductile iron for maximum durability. Double mechanical shaft seals in an oil bath, with primary seal surfaces in silicon carbide and secondary seal surfaces in silicon carbide on carbon, extend the life of the pump. A double cable-entry seal system increases the protection against moisture entering the electrical junction area.

4 Convenient handling

The top cover and motor housing are made of lightweight aluminum, which creates a pump that is very easy to handle and install.

5 Serviceability

Due to the modular design, the same parts can be used for different pumps, which lowers the overall service costs. External inspection ports for the oil and motor chambers enable quick and easy evaluation of the shaft seal during service. By removing the top cover of the pump, the electrical junction area can easily be checked.

6 Less energy and environmental impact

The high-efficiency motor and hydraulics combine with low-friction bearings to reduce power losses. The result is low total energy costs and minimized carbon footprint.



Submersible sludge pump XJS 25

XJS 25 D* -128

XJS 25 D* -143

Motor rating P2

Voltage (V)

Full load (A)

Speed

Free passage

Discharge connections

Weight (excl. cable)

Motor protection

Electric cable

2.9 kW, 3~ (4 hp)

230 / 380 / 460 / 575

9.8 / 5.9 / 4.9 / 3.9

3500 rpm

45 x 55 mm

Hose 2½", 3", 4"

Thread G/BSP 2½", 3", 4"

39 kg

Built-in

20 m

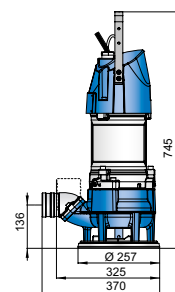
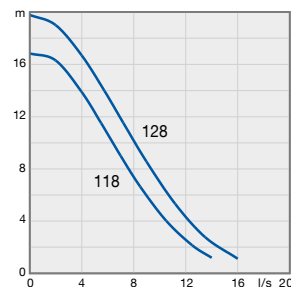

Submersible sludge pump XJS 40

XJS 40 D* -128

XJS 40 D* -143

Motor rating P2	4.3 kW, 3~ (6 hp)
Voltage (V)	230 / 380 / 460 / 575
Full load (A)	14.8 / 8.9 / 7.4 / 5.9
Speed	3470 rpm
Free passage	45 x 55 mm
Discharge connections	Hose 2½", 3", 4" Thread G/BSP 2½", 3", 4"
Weight (excl. cable)	41 kg
Motor protection	Built-in
Electric cable	20 m

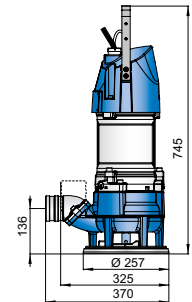
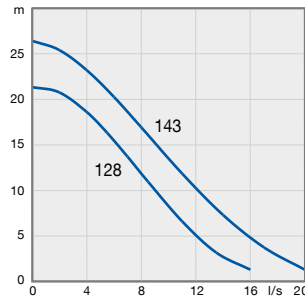

Submersible sludge pump XJS 50

XJS 50 D* -143

XJS 50 D* -160

Motor rating P2	6.7 kW, 3~ (9 hp)
Voltage (V)	230 / 380 / 460 / 575
Full load (A)	22.4 / 13.6 / 11.2 / 9.0
Speed	3520 rpm
Free passage	48 x 60 mm
Discharge connections	Hose 2½", 3", 4" Thread G/BSP 2½", 3", 4"
Weight (excl. cable)	59 kg
Motor protection	Built-in
Electric cable	20 m

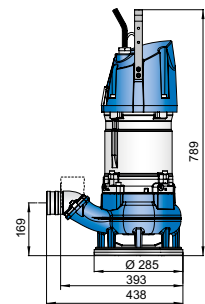
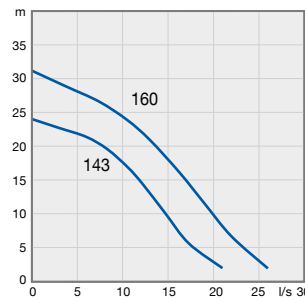

Submersible sludge pump XJS 80

XJS 80 D* -160

XJS 80 D* -175

Motor rating P2	9.8 kW, 3~ (13 hp)
Voltage (V)	230 / 380 / 460 / 575
Full load (A)	31.4 / 19.0 / 15.7 / 12.6
Speed	3520 rpm
Free passage	48 x 60 mm
Discharge connections	Hose 2½", 3", 4" Thread G/BSP 2½", 3", 4"
Weight (excl. cable)	64 kg
Motor protection	Built-in
Electric cable	20 m

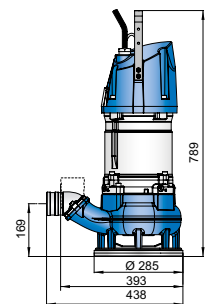
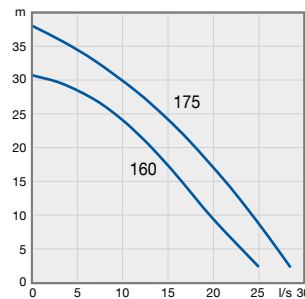

Submersible sludge pump XJS 110

XJS 110 D* -155

XJS 110 D* -166

Motor rating P2	13.5 kW, 3~ (18 hp)
Voltage (V)	230 / 380 / 460 / 575
Full load (A)	42.8 / 25.9 / 21.4 / 17.1
Speed	3500 rpm
Free passage	48 x 60 mm
Discharge connections	Hose 2½", 3", 4" Thread G/BSP 2½", 3", 4"
Weight (excl. cable)	80 kg
Motor protection	Built-in
Electric cable	20 m

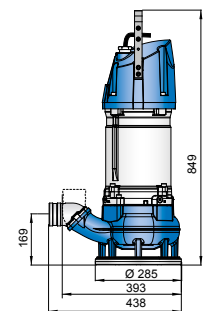
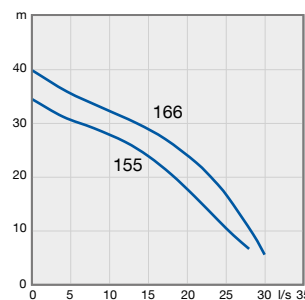

* Option: AquaTronic, built-in electronic pump control.

Dewatering pumps with built-in AquaTronic

Submersible dewatering pumps XJ 25-110, XJC 50-110 and XJS 25-110 have several options for electronic supervision that make them even more reliable and easy to use. Most important is the AquaTronic unit, which ensures correct motor rotation, gives motor protection, allows the pump to start via a level sensor and gives you all the performance information in your PC, and much more.

Built-in AquaTronic

The contactor in the basic pump configuration can be replaced with an AquaTronic unit for built-in intelligence. The AquaTronic unit should be ordered when ordering the pump.

Ensures correct motor rotation

The AquaTronic unit automatically controls phase order and changes the motor connection to make sure the pump starts with the correct impeller rotation every time. This ensures that full capacity is obtained from the installed pump, it saves energy and reduces wear.

No control panels needed

The built-in pump electronics eliminate the need for traditional electrical control panels. This increases ease of handling.

Motor protection ensures safe running

The pump stops if there is a power overload at high amperage, a high temperature in the winding or a missing phase. In this way any crucial failures can be prevented.

Anti-clog function reduces unwanted stops

If the pump fails to start due to a heavy start or a locked rotor, the pump will attempt to free the blocked impeller with backspin and automatic restart.



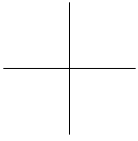

The AquaTronic unit in the pump work in stand-alone mode, but when adding the electronic accessories below, more of the unit's functions can be accessed.

Dewatering pump with AquaTronic and level sensor or float switch

A level sensor connected to the AquaTronic makes sure the pump starts and stops at given water levels.

The pump can also be set to stop when the pump runs dry and start again at a specified level. This lowers the power consumption and minimizes wear.



Dewatering pump with AquaTronic and AquaPlug/AquaTronic control panel

When using an AquaPlug/AquaTronic control panel you will get access to additional features included in the AquaTronic unit.

The pump can be set to energy save mode for automatic on/off functionality with level sensors.

Both units provide flashing LED light alarms as well as indications of important parameters for easy and efficient handling, such as the service indication light that helps to easily spot alarms.

Another function is the automatic restart when power supply problems, such as unbalanced voltage or low/high voltage, are solved.

You can easily stop and start the pump with the AquaPlug and AquaTronic control panel.



Built-in intelligence with service diagnostics program

Check the pump conditions without disassembly by simply connecting the pump to a PC via a USB cable for access to the service diagnostics program. The program will show the pump data saved in the pump's built-in memory such as:

- Pump status data
- Pump operating history
- Pump failure history
- Pump service/maintenance history
- Digital manual and spare parts documentation



Overview of electronic supervision features

AquaTronic

Key benefits of the AquaTronic unit include:

- Correction of motor rotation if phases are improperly connected
- Run mode - no control panels needed
- Integrated start equipment (direct or soft start depending on pump model)
- Motor protection against high temperature, high amperage and missing phase

If the pump is also equipped with an optional level sensor, AquaTronic provides:

- Precise level control
- Protection against dry running

AquaTronic service diagnostic program

Connecting a PC to the AquaTronic unit via USB cable provides access to the service diagnostic program, which offers:

- Pump status data (temp, voltage, moisture, etc.)
- Pump operating history
- Pump failure history
- Pump service and maintenance history
- Digital manual and spare parts documentation

AquaPlug and AquaTronic control panel

AquaPlug and AquaTronic control panel are options that combine with AquaTronic to provide additional alarm and start/stop functions, as well as indications for important parameters. AquaPlug is incorporated into the power line via 16 A or 32 A sockets.

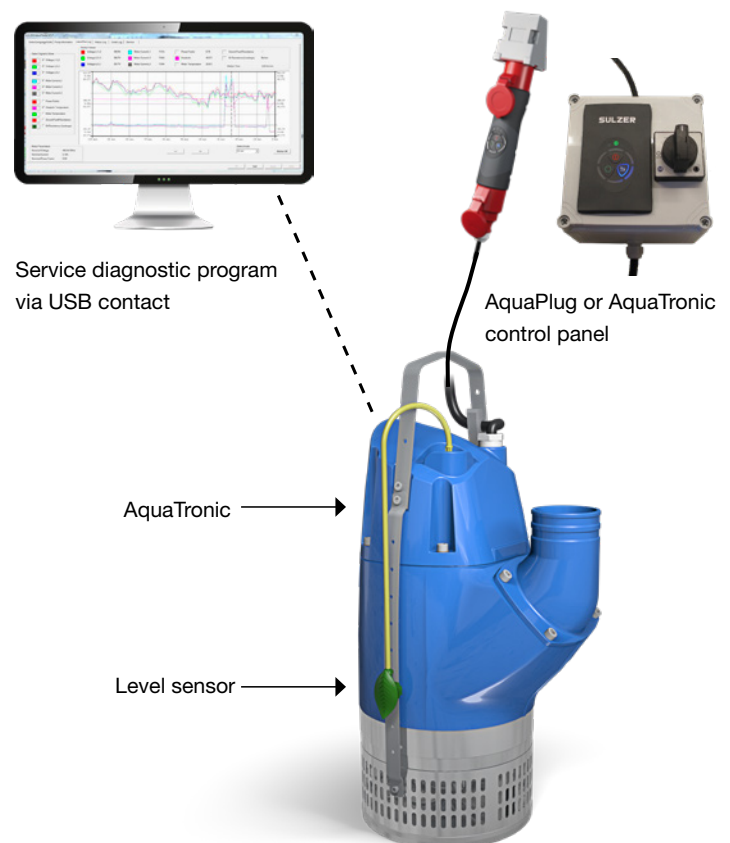

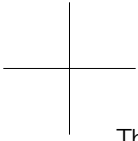

The table below shows the range of features available when the AquaTronic unit and other electronic supervision options are used with the submersible dewatering pumps XJ 25-110, XJC 50-110 and XJS 25-110.

Electronic supervision feature	Basic pump configuration with contactor	Pump with AquaTronic	Pump with AquaTronic + level sensor	Pump with AquaTronic + AquaPlug/ AquaTronic control panel	Pump with AquaTronic + AquaPlug/AquaTronic control panel + level sensor
Run mode	●	●	●	●	●
Integrated start equipment	●	●	●	●	●
Automatic correction of rotation		●	●	●	●
Motor protection – high temp	●	●	●	●	●
Motor protection – high amp		●	●	●	●
Protection against missing phase		●	●	●	●
Level control			●		●
Protection against dry running			●		●
Automatic restart			●		●
Stop mode				●	●
E-mode (automatic stop/run)			●		●
Indication of water in oil				●	●
Indication of low motor insulation				●	●
Indication of high/low voltage				●	●
Indication of high temp				●	●
Indication of high amp				●	●
Indication of phase imbalance				●	●
USB cable connection		●	●	●	●

● = Fault indication when pump is automatically stopped to protect the motor

Pump options and accessories

AquaTronic unit for correct motor rotation

Our built-in AquaTronic unit integrates electronic intelligence into the pump, ensuring correct motor rotation by automatically adjusting for incorrect phase order. It also protects the motor by stopping the pump in the event of over-ampereage, overheating, low or high voltage or missing phase. Another feature of the AquaTronic unit is the internal software that allows pump performance and service diagnostics data to be viewed on a PC via USB link, enabling accurate evaluation of service and maintenance needs. The workshop manual and spare parts list, readily available in the AquaTronic unit, can be viewed via the link as well. The AquaTronic unit should be ordered when ordering the pump.

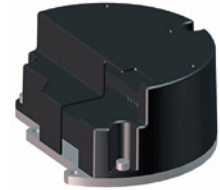

AquaPlug and AquaTronic control panel

AquaPlug and AquaTronic control panel are options that combine with AquaTronic to provide additional alarm and start/stop functions, as well as indications for important parameters. AquaPlug is incorporated into the power line via 16 A or 32 A sockets.



Level sensor for precise and cost effective water level control

Together with AquaTronic, the level sensor provides precise and cost-effective water level control, and helps lower power consumption.



SoftDrive for cost effective operation

Sulzer offers a built-in SoftDrive concept on the J 205 pumps. It reduces starting current dramatically and provides smooth operation for both the power net and pump equipment. The pump can be started with a smaller-sized generator compared to a standard pump started directly on-line.



Quick and easy installation with flotation ring

Sulzer offers a solution for pumps up to 45 kg. The ring is easy to install and can be used with dewatering pumps J 12 - J 15, XJ 25 - XJ 40.



Flotation system to prevent unnecessary wear

An easy-to-install flotation system for pumps up to 1'300 kg. Can be used as a series installation with several pontoons. The system is mainly designed for J 205 - J 604 and XJ 900.

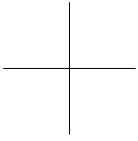

Zinc anode belts for more durable operation

Sulzer submersible dewatering pumps can easily be fitted with zinc anode belts providing protection against galvanic corrosion. The cast parts of the pump can also be protectively coated, ensuring trouble-free operation when pumping salty or brackish water.

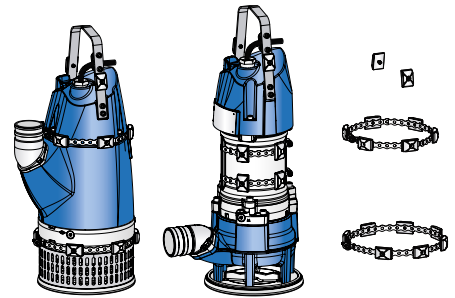

Polyurethane for prolonged drainage pump life

Sulzer offers wear rings in polyurethane, which increases resistance when pumping fine sand and other abrasive mediums. Polyurethane-coated wear rings are available as an option on J 205 - J 604.

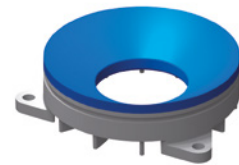

Series connections for pumping high heads

With minimal effort, the standard Sulzer drainage pumps can be rebuilt to function in series for high head applications.

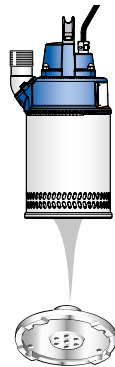

Bottom suction adapter for total water removal

On pumps J 12 - J 15, the standard bottom plate may be replaced by a bottom suction adapter. A basement floor or a tank can be pumped practically dry with this adapter.



Repair kits that save time and money

Sulzer offers repair kits for all submersible dewatering pumps. The repair kits include common parts required for a typical repair. Our modular pump design makes it possible to repair all drainage and sludge pumps with just a few repair kits.

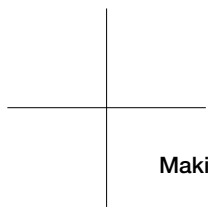

Making water go around. Water and wastewater solutions by Sulzer.

Sulzer offers a broad range of pumps and related equipment for water production and transportation as well as wastewater collection and treatment for municipalities and industries. Our expertise also includes separation technologies, and services on rotating equipment.

E10361 en (60 hz) 6.2023, Copyright © Sulzer Ltd 2023

This brochure is a general presentation. It does not provide any warranty or guarantee of any kind. Please, contact us for a description of the warranties and guarantees offered with our products. Directions for use and safety will be given separately. All information herein is subject to change without notice.

