

Leading Tray Technology

Reliability and Performance

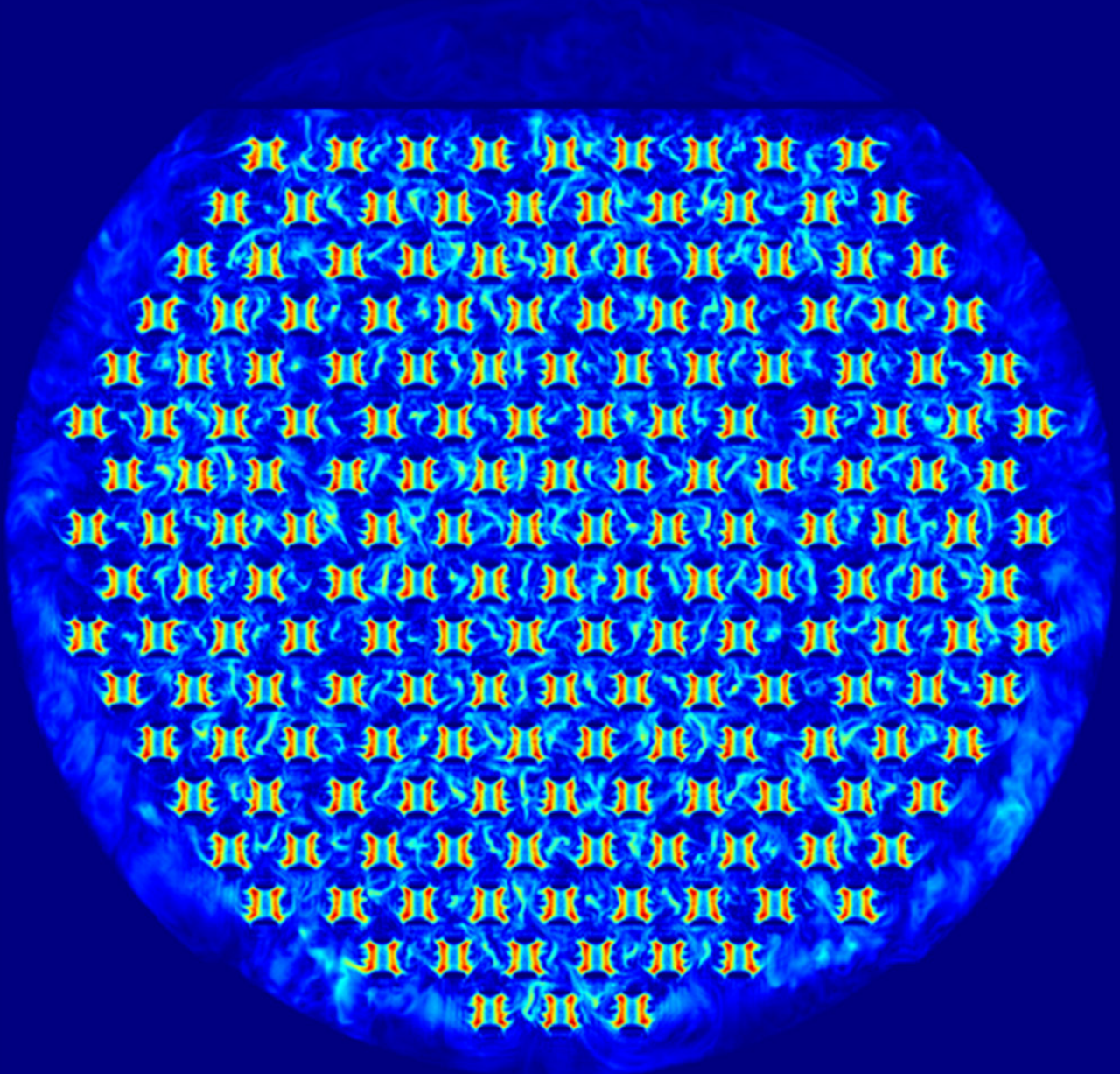

Sulzer Chemtech – Mass Transfer Technology

Your partner in separation and mixing technology

The highest level of application know-how

Our team provides state-of-the-art expert know-how for more than 500 applications in 100 processes, this enables us to optimize the performance and your installation.

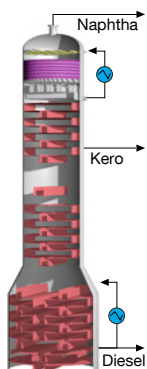

Fast and reliable turnaround services

We don't shut-down, when you shut-down. You can rely on Sulzer professionals, expertise and procedures to get you back and running in the shortest possible time.



Comprehensive engineering and technology services

We provide a full scope of associated engineering and technology services to optimize or trouble-shoot your installation.



A broad range of innovative and high-performing products

Our more than 200 products cover a wide range of needs in the field of separation and mixing technology.

They have proven their performance in more than 100'000 columns, 50'000 gas/liquid or liquid/liquid separators and 100'000 static mixers in operation worldwide.



MellapakPlus™ Packing

Often copied, never equaled



UFMPlus™ trays

One of the best high performance trays ever tested at FRI



NeXRing™

The next big thing in random packing



SMV™ static mixer

High mixing efficiency combined with large turn-down processing capabilities



Dusec Plus™ Coalescer

High performance liquid/liquid coalescer

Conventional trays for special applications	4
Conventional valves	6
High performance valves	8
Sulzer high performance trays	10
Shell high performance trays	12
Internals	16
Mechanical features and services	20

We understand the ever increasing requirement for both reliability and performance of your process equipment. To meet these challenges, you can rely on our innovative, industry-leading products and expertise. Our extensive tray portfolio ranges from single pass to multi-downcomer as well as conventional to high-performance, including the latest technology in ultra-system limit trays. All designs are tailored to meet the exact requirements of your specific application.

For your most demanding applications, our High Performance Trays include VGPlus™ trays with MVG™

decks and enhanced downcomer technology as well as the newest trays, UFMPlus™ with UFM™ valves. The UFM valve is an industrially proven, advanced movable mini valve providing the highest efficiency and capacity. For fouling applications, Sulzer has developed a new high performance anti-fouling valve UFM™ AF, which provides high capacity in addition to its superior fouling resistance. This portfolio has been greatly enriched since 2000 by our technology alliance with Shell Global Solutions, and also includes Shell high performance trays such as the Shell HiFi™ trays, ideal for high liquid load applications, and Shell ConSep™ trays with proven ultra-system capabilities.

Tray portfolio

Sulzer technology				Sulzer-Shell alliance	
Conventional trays		Chordal downcomer High performance trays		Multi downcomer High performance trays	
Floating valves	Other orifices	Enhanced deck	Enhanced deck and downcomer		
BDHT™ / BDP™	Bubble Cap	Floating valves	VGPlus™	Shell HiFi™ Plus	
Round valves	Sieve	UFM™	UFMPlus™	Shell HiFi™	
Fixed valves	Counter flow trays	Fixed valves		Shell Calming Section™ Plus	
XVG™	Dual Flow	MVG™		Shell Calming Section™ (CS)	
SVG™	Baffle	MMVG™		Dual flow high performance trays	
SVG-H™	Shower Deck	UFM™ AF		Shell CS Grid™	
LVG™	Disc and Donut			Ultra-system limit high performance trays	
Slit Trays™				Shell ConSep™	

Conventional Trays for Special Applications

Sieve trays for simple solutions

Sieve trays are widely accepted as a low cost mass transfer device where high turndown is not required. Sulzer offers all common sieve tray designs including smaller holes for higher vapor capacity and venturi holes for lower pressure drop.

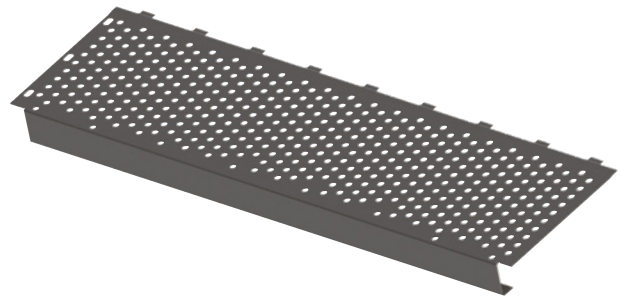

Sieve Tray Panel

Bubble Cap trays for high turndown

Bubble Cap trays are generally used for low liquid loads and have a very high turn down ratio. Sulzer offers a standard cap for 3" and 4" and a slotted type for 6". Applications include amine absorbers, regenerators and caustic towers.

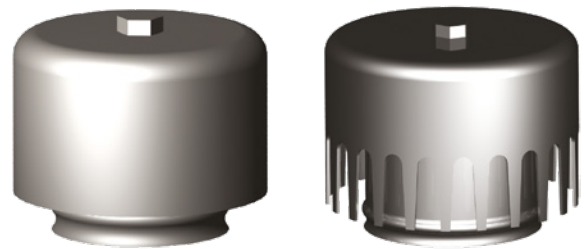

Bubble Caps

Dual Flow trays for fouling conditions

Dual Flow trays are perforated trays with no downcomer. They are typically equipped with large holes which make them particularly suitable for fouling applications.

For services with moderate fouling but requiring the efficiency of cross-flow trays, Sulzer offers high performance VG AF Anti-Fouling trays.

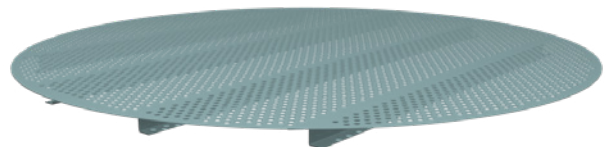

Dual Flow Trays

Baffle, shower deck, disc & donut trays for severe fouling conditions

These trays are typically applied in severely fouling services. They are configured so that the liquid flows downward through the column, splashing from one baffle to the next lower one. Ascending vapor contacts the liquid by passing through the liquid curtains. These trays are used in washing sections where fouling resistance has priority over high efficiency.

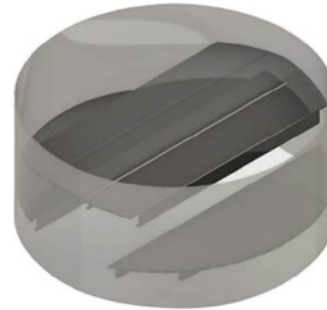

2-Pass Baffle Trays

Cartridge trays for small columns

Cartridge trays are typically used for small flanged columns where physically installing the trays inside the column is not feasible. Column diameters range between 300 to 800 mm (12" to 30"). Cartridge trays are assembled in bundles for easy and fast installation. They can be equipped with all types of tray decks and downcomers.

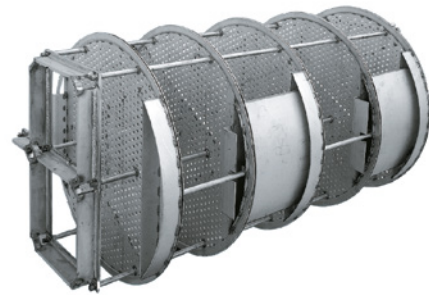

Cartridge Tray

LLE for liquid-liquid extraction

Conventional extraction trays are designed with holes punched in the tray deck. Sulzer extraction trays are equipped with enhanced downcomers and extruded holes which allow:

- Higher fouling resistance
- More uniform droplets, thus higher efficiency
- Wider operating range



Extruded holes from liquid-liquid extraction holes

Slit Trays™ for high efficiency

Slit Trays are high efficiency, radial liquid flow devices featuring rows of concentric slits for vapor passage. They are mainly used for the distillation of aqueous systems and specialty chemicals. Features of Slit Trays:

- Low tray spacing: 150 - 250 mm (6" – 10")
- High fractionation stages per given column height
- Self supporting structure
- High turndown ratio, up to 4:1
- Suitable for 2 liquid phase systems

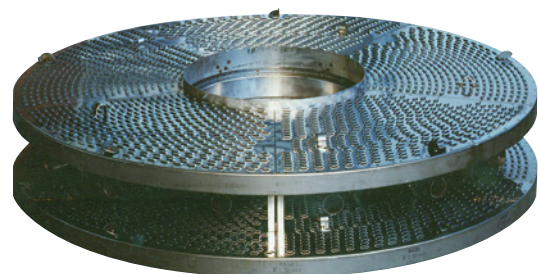

Slit Trays™ type

Conventional Valves

Floating valves for wider operation flexibility

BDH™

The unique rectangular-shape sets the BDH apart from the conventional round valves. The BDH is oriented parallel to the liquid flow direction, providing lateral vapor release and a closed upstream edge to minimize weeping. This contributes to an improved efficiency/capacity profile compared to conventional round valves.

Further advantages of the rectangular valves:

- Improved liquid flow along the flow path of the tray deck
- Wider operating range than round valves
- Robust mechanical design due to wide legs
- Anti-rotating which reduces wear and tear

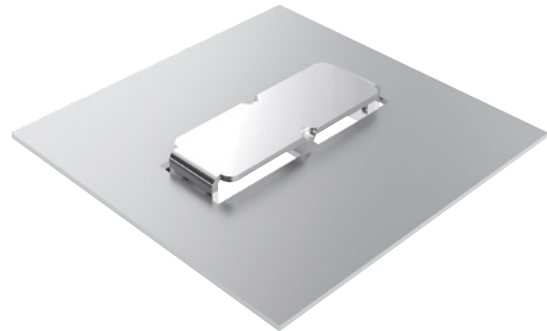

BDH™ floating valve

Round Valve

Sulzer offers conventional round valve trays for replacement or whenever requested by the customer.

There are two types of round valves available, conventional and caged valves.

The conventional valve types available are:

- RV1 for flat decks
- RV4 for decks equipped with venturi holes for lower pressure drop

The caged types available are:

- RC1 for flat decks
- RC4 for decks equipped with venturi holes for lower pressure drop



Round valve

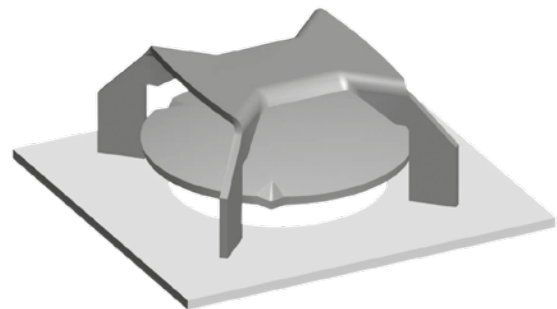

Caged valve

Fixed Valves for lower pressure drop

V-Grid

V-Grid tray technology utilizes fixed valves and combines the attributes of sieve holes and float valves. V-Grids offer low pressure drop while delivering high tray performance in terms of capacity and efficiency.

The tapered, rectangular valves are extruded from the tray deck and oriented parallel to the liquid flow providing unique advantages compared to sieve holes:

- Lower froth height, less entrainment due to lateral vapor release
- Increased capacity and improved turndown
- High efficiency over a wide operating range
- Superior mechanical strength
- Excellent fouling resistance

Smaller valves provide more capacity than larger ones due to reduced pressure drop and entrainment rate. To meet your requirements we offer following standard sizes: MMVG™, MVG™, SVG™ and XVG™.

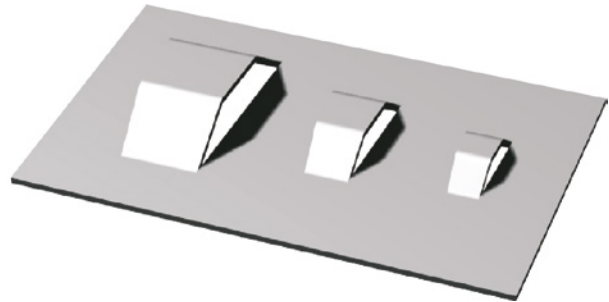

SVG™

SVG valves are high lift fixed valves. These large lateral openings produce a vapor cleaning effect on the tray deck which results in excellent operational performance in fouling services, guaranteeing a long run time.

Sulzer also offers the SVG-H™ fixed valve, which is fitted to the deck rather than extruded. This method is used to avoid cracking in materials such as titanium, zirconium and inconel.

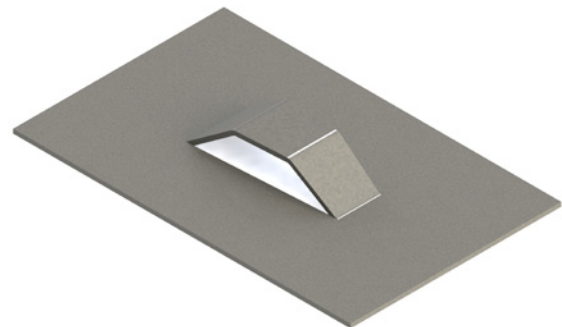

SVG™ Valve

XVG™

XVG (Extra Large V-Grid) valves are intended for severe fouling services.

The valves can be combined with other anti-fouling design features, such as modified outlet weirs and push valves to minimize the accumulation of solids on trays.



XVG™ Valve

High Performance Valves

For higher capacity and lower pressure drop

MVG™

MVG valves provide higher capacity compared to standard sieve holes or conventional valves while providing higher efficiency and lower pressure drop. The MVG valves offer better turndown capability than a sieve tray, i.e. up to 3:1.

MVG valves are well proven in various industrial applications ranging from low to high pressure distillation, i.e. atmospheric towers to C3 Splitters.

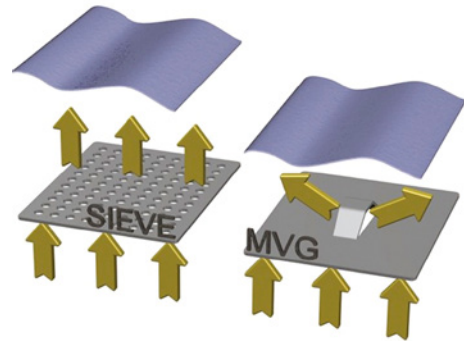

FRI VALIDATION

Sulzer MVG Trays have been successfully tested in the C6/C7 system at 0.34 and 1.64 bara pressure. Measurements showed up to a 20% advantage in capacity and efficiency compared to sieve trays.

MMVG™

MMVG valves are used where extremely high vapor capacity is required. The smaller size opening compared to MVG results in up to 7% additional capacity with equivalent tray efficiency.

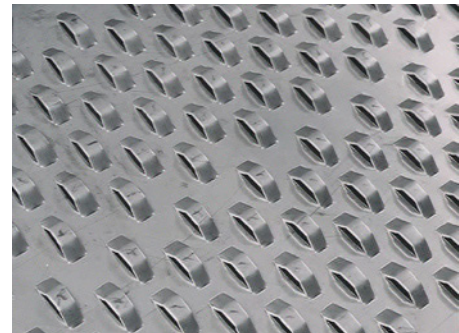

MMVG™ Valve Tray

UFM™ AF

UFM AF is the latest addition to our anti-fouling valve family. These fixed valves have high vapor handling capacity, similar to that of UFM, and high fouling resistance.

KEY AREAS OF APPLICATION

- Atmospheric and Vacuum Towers, Coker, HF Alkylation, Waste Water Towers
- Primary Fractionators, Depropanizers, Debutanizers, Caustic Towers, Butadiene Towers, Amine Contractors
- Beer Columns, PVC Slurry Strippers

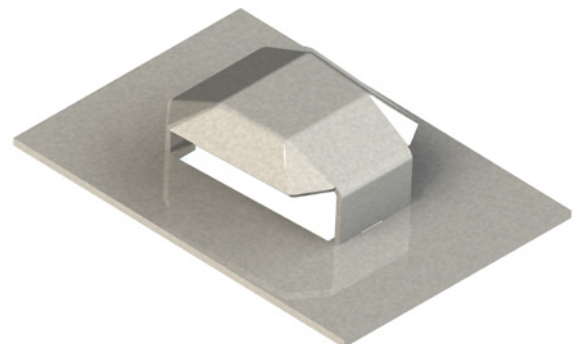

UFM™ AF Valve

For higher capacity and wider operation flexibility

UFM™

UFM valves are an advanced type of movable mini-valves which maximize the hydraulic capacity, the separation efficiency, and the operating range of fractionation trays.

The distinctive “Umbrella” shape:

- Reduces vertical jetting momentum of the vapor, minimizing entrainment and providing higher capacity
- Maximizes contact area between vapor and liquid on tray deck for higher efficiency
- Minimizes pressure drop while maximizing the operating range of the movable valve



UFM™ Valve

UFM valves are oriented parallel to the liquid flow to minimize hydraulic gradient along the flow path of the tray. Distinctive features are:

- Two wide legs to maximize robustness, minimizing wear and tear
- Four spacers which prevent valves sticking to the tray deck

UFM valves should be used when both high performance and wide operating range are needed for any distillation column, absorber and regenerator.



UFM™ Tray Deck

FRI VALIDATION

Sulzer UFM valves have been tested at FRI, in the cyclo-hexane/n-hexane system at 1.6 bar and in the ortho-xylene/para-xylene system at 1.0 bar. The UFM valves showed a 30% higher capacity at comparable or higher efficiency than conventional valves, making the UFM tray one of the highest capacity trays ever tested at FRI, at these conditions.

KEY AREAS OF APPLICATION

- Main fractionators of refineries
- Gas concentration columns of refineries
- Light ends columns of petrochemical plants
- LNG / NGL fractionation columns
- Absorbers & regenerators of gas sweetening plants

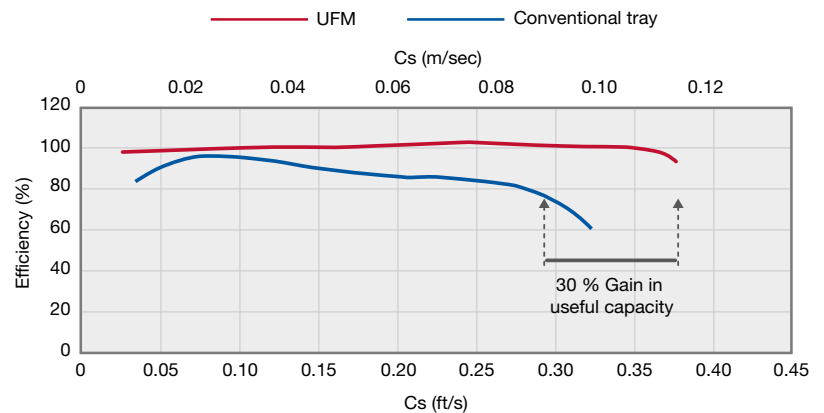

Cs: = Capacity factor based on superficial area
Efficiency 1.6 bar
Cyclohexane/normal heptane

Sulzer High Performance Trays

For higher capacity

UFMPlus™ and VGPlus™

UFMPlus and VGPlus Trays, are Sulzer's high performance chordal downcomer trays. They offer industry proven and validated advanced tray technology.

High capacity UFMPlus and VGPlus make use of enhanced downcomers such as truncated, StepArc™, ModArc™ or Prism downcomers, for larger active area for higher vapor capacity. Their decks are equipped with UFM and MVG/MMVG high performance valves respectively, for higher vapor handling capacity.



2-pass UFMPlus tray equipped with Prism downcomers, UFM™ and push valves.

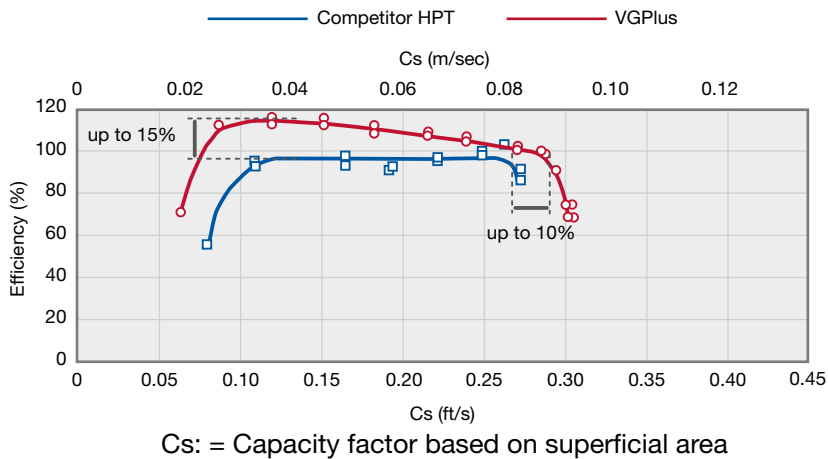

Comparing against Conventional Trays

- Higher capacity: up to 30%
- Lower pressure drop: up to 20%
- Equal or higher efficiency
- Elimination of hydraulic gradient
- Uniform liquid flow and vapor distribution

Please refer to **Sulzer High Performance Trays brochure** for more information on Sulzer UFMPlus and VGPlus, as well as their areas of applications and case studies.



See pages 6-8

For higher fouling resistance

UFM™ AF

UFM AF is the latest addition to our fixed valve portfolio. This enhanced valve is part of the UFMPlus tray family, developed for fouling service.

UFM AF is a large size valve which provides excellent fouling resistance, especially when designed with the following anti-fouling features on the tray:

- Modified outlet weirs: stepped or sloped
- Push valves

UFM AF is a premium anti-fouling valve with very high efficient capacity. Enhanced downcomers can be applied to UFM AF trays for even higher capacity, if required.

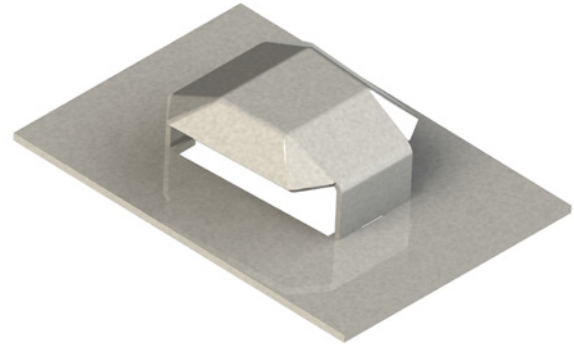

UFM™ AF Valve

VG AF™

VG AF (AntiFouling) trays are part of the VGPlus tray family and especially designed for fouling services.

Tray decks of VG AF will either be with SVG, our standard anti-fouling valve, or XVG, our extra large V-Grid developed especially for severe fouling services. Other anti-fouling tray design features like enhanced outlet weirs and push valves will also be applied.



2-pass VG AF trays with V-Grid, sloped outlet weir and push valves.



Please refer to **Sulzer High Performance Trays brochure** for more information on Sulzer Anti-Fouling Trays, as well as their areas of applications and case studies.



See page 9

Shell High Performance Trays

Shell HiFi™ Plus trays

Shell HiFi trays are high capacity fractionation trays equipped with multiple envelope downcomers.

The HiFi Plus trays are an enhanced version featuring advanced valves (i.e. MVG, MMVG, UFM) to further boost the tray deck performance, and may include the Crown Inlet Device CID™ to maximize the downcomer capacity as well.

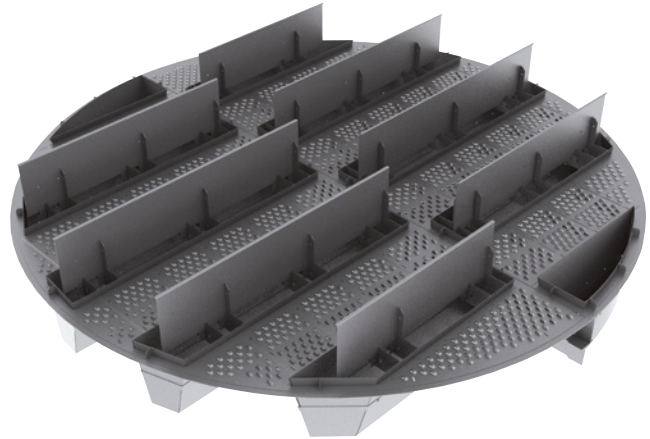

HiFi™ Plus tray with MVG™ valves

Self balancing operating

- The unique orientation of the HiFi downcomers creates a more uniform liquid distribution on the tray deck (blue arrows).
- The vapor is uniformly distributed underneath the tray deck and released laterally through the MVG valves perpendicular to the liquid flow (red arrows).
- Both liquid and vapor are naturally selfbalanced across the entire tray for the most uniform mixing, contacting, and separating efficiency.
- The liquid flow path lengths are uniform across all over the entire tray.

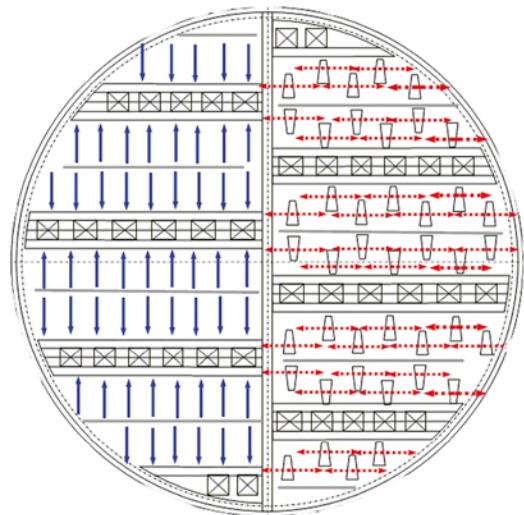

Top view of HiFi™ Plus tray

Please refer to **Sulzer High Performance Trays brochure** for more information on Shell HiFi (Plus) trays, as well as their areas of applications and case studies.



See pages 10-11

Shell HiFi™ Extraction trays

Shell HiFi extraction trays are particularly well suited for liquid-liquid extraction systems with interfacial tensions below 25 dyne/cm and large phase ratios. They can be used to increase the capacity of existing towers in aromatics extraction, caustic treating and lube oil applications.

Shell HiFi extraction trays vs. conventional sieve trays:

- up to 15% additional capacity with same efficiency
- less tray spacing without capacity loss

Shell HiFi extraction trays vs. Rotating Disc Contactor in Sulfolane extraction:

- up to 25% additional capacity and 20% more separation stages

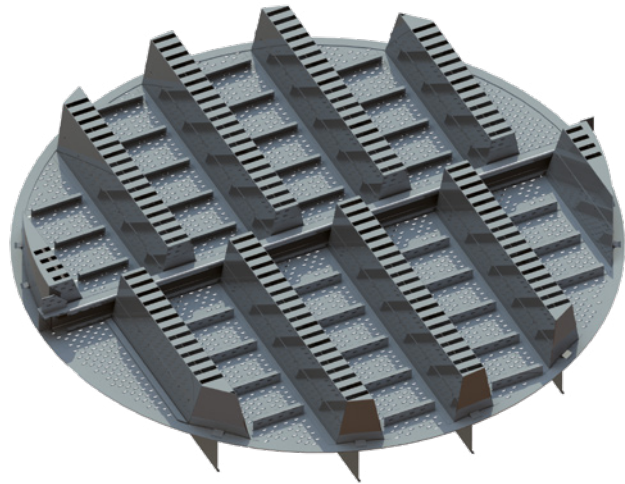

Shell HiFi™ extraction trays equipped with upcomers

KEY AREAS OF APPLICATION

- Benzene Extraction, Butadiene Wash, Isoprene Purification, DCH and ECH Recovery from Heavy Ends
- LP Sweetening, Lube Oil Extraction

Shell High Performance Trays

Shell CS Grid™ trays

Shell CS Grid trays are high capacity dual flow trays constructed with adjacent round or flat bars. Open area is defined by the size and pitch of the bars.

These trays are equipped with 4 vertical baffles oriented radially to achieve the most uniform froth distribution over the tray deck. Each tray is rotated 45° respective to the tray above for most uniform vapor and liquid contacting. They are supported on a 360° support ring and major beams.

Shell CS Grid trays are mainly used for heat transfer services in fouling and/or corrosive environments.



Shell CS Grid™ trays equipped with round bars

KEY AREAS OF APPLICATION

- Slurry pumparound of FCC Main Fractionators
- Oil and water quench towers of Ethylene plants
- Top pumparound of CDU and Coker Main Fractionators
- Bottom pumparound of Visbreaker and Thermal Cracker Main Fractionators

Shell ConSep™ trays

Shell ConSep trays are one of the highest capacity fractionation trays available on the market, offering up to 80% additional capacity over conventional trays without any major impact on separation efficiency.

They utilize the principle of de-entrainment by centrifugal force to overcome the gravitational limitation of jet flooding and the system limit of the vessel.

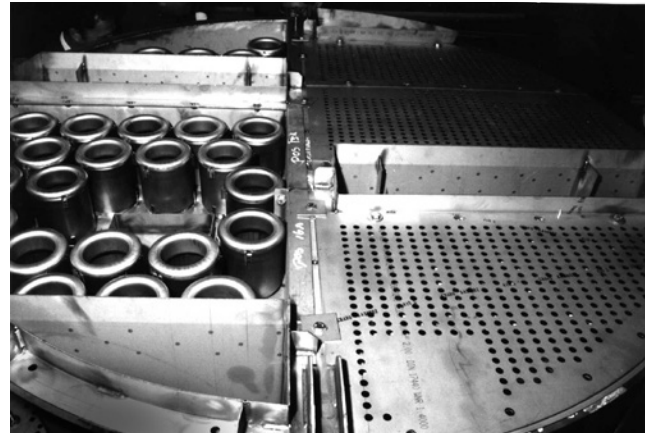

Shell HiFi™ Sieve Trays with ConSep™ decks

Operating mechanism

Shell ConSep trays start to work when the conventional trays reach incipient flooding. The vapor carrying entrained liquid, before reaching the next tray, passes through the swirl tubes where the entrained liquid is separated by means of centrifugal acceleration and is collected on the swirl tube deck which is then refluxed back to the downcomer below by means of a secondary downcomer. Thus only clear vapor will rise up to the tray above.

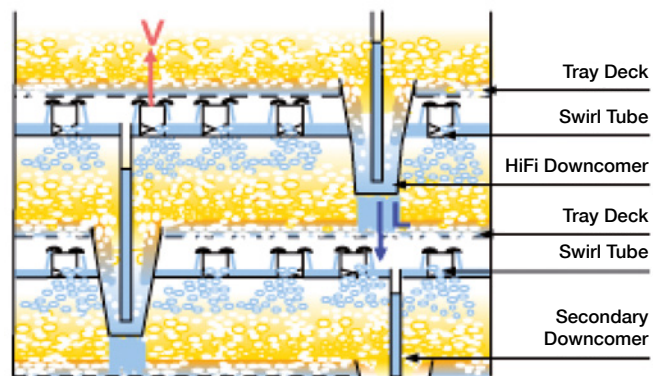

Please refer to **Sulzer High Performance Trays brochure** for more information on ConSep trays, as well as their areas of applications and case studies.



See pages 12-13

Internals

Internals for trayed columns

Internals inside trayed columns such as feed inlet distributors are pivotal to the performance of the column. Proper design of these essential internals is the key in ensuring steady operation and optimal tray performance.

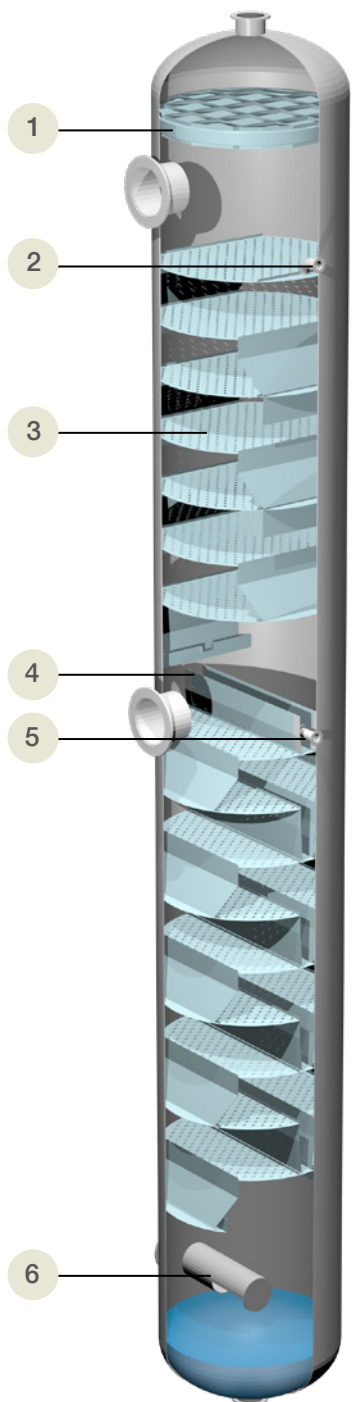

Chordal Downcomer Tray

- 1. Mist eliminator**
Mist Eliminator above top tray, to minimize liquid carryover in the overhead vapor.
- 2. Reflux feed inlet**
Sulzer will design the optimal feed inlet considering the feed loadings, nozzle size, nozzle orientation and tray type.
- 3. Trays for your application**
Sulzer's extensive tray portfolio allow us to offer the optimum trays specifically designed for your application.
- 4. Transition**
Custom designed transitions are critical for optimal column operation.
- 5. Intermediate feed inlet**
The design for intermediate feed inlet requires special care. The design has to achieve good distribution to the tray designs above and below the feed inlet.
- 6. Vapor feed (reboiler) inlet**
Sulzer offers customized solutions for the optimal vapor distribution.

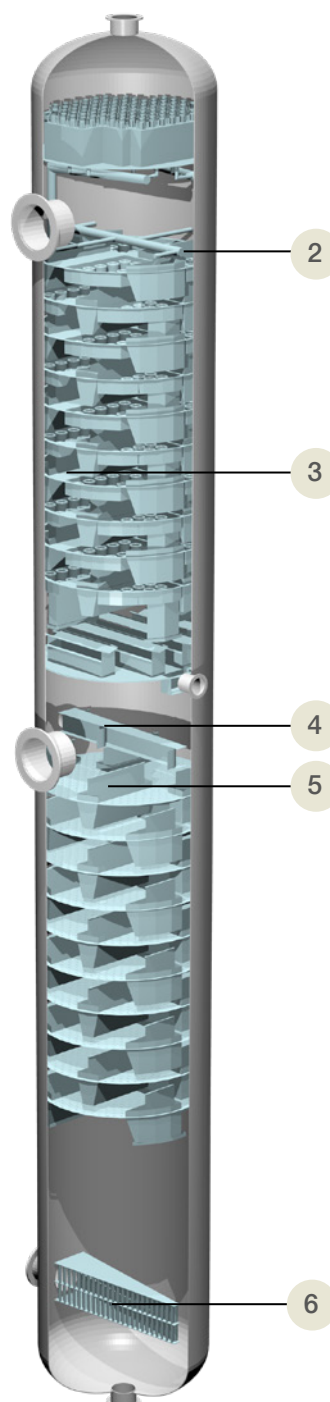

Shell Tray

For liquid feed distribution and draws-off

Liquid feed distribution

Every Sulzer liquid distribution system is customized based on tray geometry, nozzle orientation and feed condition to ensure good distribution to the trays.

A good liquid distribution system is especially important for multi-pass trays, such as 4-pass and 6-pass because any mal-distribution to the different tray sections could lead to poor column performance.

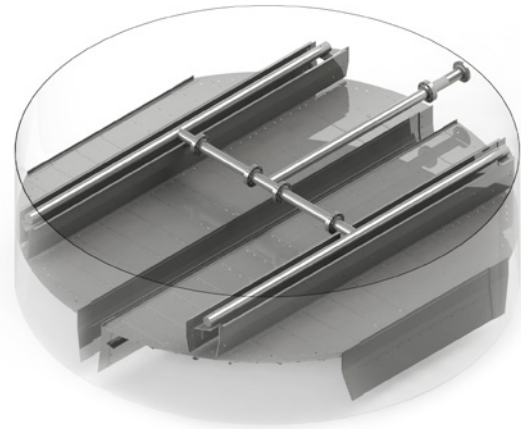

Liquid Inlet to a 4-pass tray

Liquid draw-off

Liquid can be drawn from the column as a side-product or pumparound.

A well designed draw-off system ensures:

- Adequate draw-off nozzle sizing for the liquid amount to be drawn
- Sufficient residence time for deaeration of the liquid
- Adequate liquid hold-up volume for smooth column operation with the draw-off system

Depending on the process conditions, the draw-off system can be as simple as the draw-off from the double sealpan under downcomer (shown below).

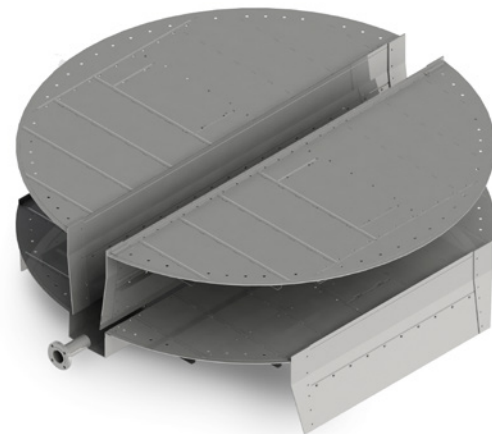

Liquid drawoff from center downcomer of a 2-pass tray

For draw-off systems which require longer residence time, or total liquid draw-off, a chimney tray liquid collector can be used.

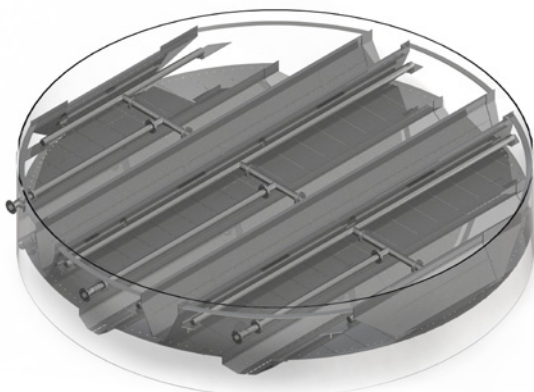

Intermediate Liquid Inlet to a 6-pass tray

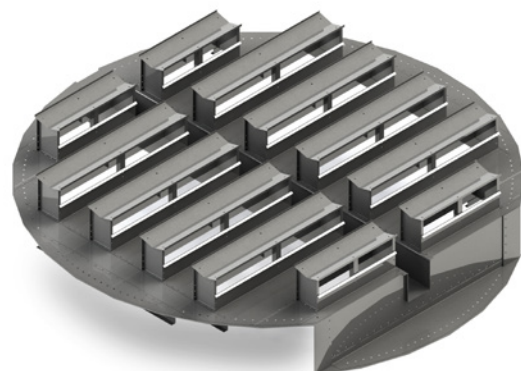

Chimney tray liquid collector

Internals

For vapor and mixed feed distribution

Vapor and mixed feed distribution

Vapor maldistribution can lead to localized flooding and/or weeping which can reduce column performance.

For an optimum vapor inlet system, Sulzer customizes the solution according to the tray geometry, nozzle orientation and feed condition.

For flashing intermediate feeds onto a tray, an inlet V-baffle at the feed nozzle can minimize liquid entrainment and provide a better vapor distribution by directing the vapor to the sides of the column wall.

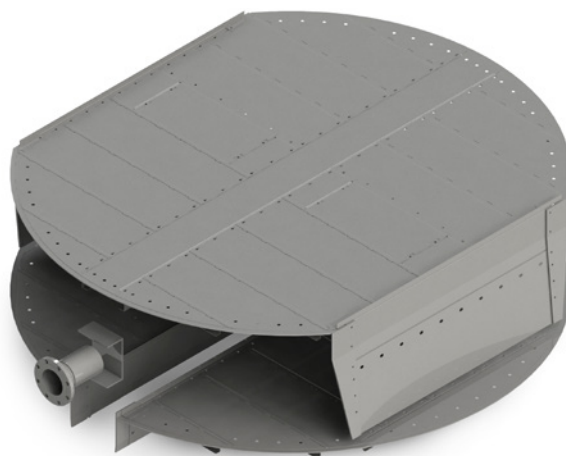

Vapor Feed to a 2-pass tray

Shell Schoepentoeter™, Shell Schoepentoeter Plus

Shell Schoepentoeter is a well known vane-type radial feed inlet device.

Shell Schoepentoeter Plus is an enhanced version of the Schoepentoeter, with the same vapor distribution performance but with a higher gas-liquid separation capability. Testing shows that liquid entrainment can be reduced by 33% compared to a conventional Schoepentoeter.

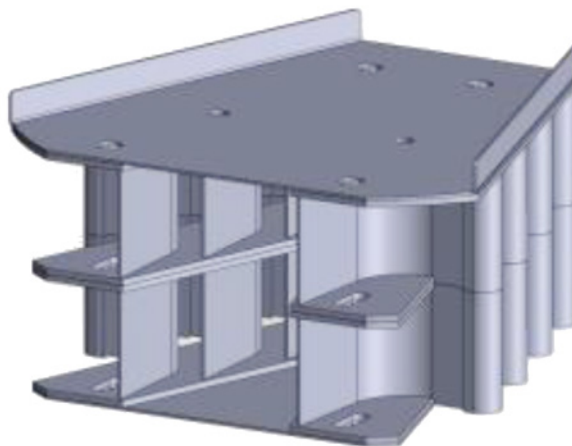

Schoepentoeter Plus

For transition

Tray-to-tray transitions

Vapor and liquid loadings inside the column can vary drastically for different tray sections due to process conditions. Often, the most economic design is to equip columns with sections of trays with different number of passes or with different diameters.

A proper transition between the different layouts is critical to avoid mal-distribution of liquid and vapor which could lead to reduced column performance.

Sulzer provides customized solutions based on the tray geometry (2-pass, 4-pass and 8-pass etc), orientation and the internal loading to ensure optimal transition.



Transition from a 1-pass tray to a 2-pass tray over a conical section.

Tray-to-packing transitions

It is common for modern refineries to use both tray and packing sections within a single column.

With excellent engineering know-how in both tray and packed bed technology, Sulzer can provide optimized solutions to overcome the challenges by ensuring proper vapor and liquid distribution throughout the entire column.

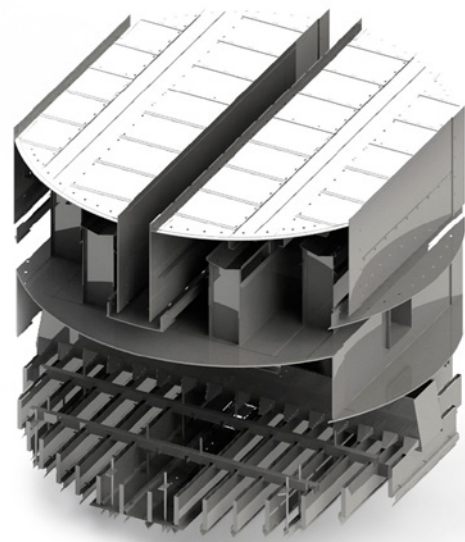

Transition from a 4-pass tray to a packed section with a trapout for partial draw-off.

Mechanical Features

Non-welded tray support system

In several revamp projects aimed to increase the separation stages of an existing column, the number of actual trays had to increase (e.g. 3-for-2, 4-for-3, or 5-for-4).

To accomplish this, a mechanical design is required to avoid impact on the schedule of the plant's turn-around, and minimize cost as well.

Sulzer has developed a mechanical solution enabling installation of the trays by reusing the existing tower attachments, without any direct welding to the tower wall, thus avoiding any post-welding heat treatment and/or hydraulic testing of the vessel. This technique consistently reduce the turnaround time by using this technique.

The following devices show in the illustration below are used:

- Expansion rings
- Expansion joints
- Vertical struts
- Downcomer adaptors
- Solid or lattice beams

The system can be also used for other purposes: modify the geometry of existing downcomers, modify the number of passes; change the tray orientation; replace packing beds with trays.

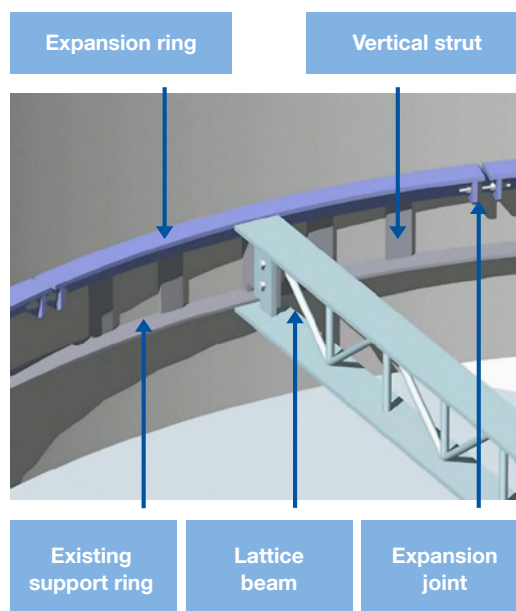

Trays for heavy duty services

In some applications, particularly those subjected to operating upsets leading to panel dislodgment, the trays must withstand higher than normal mechanical loadings, i.e. 7000 N / m² (1 psi) or even 14000 N / m² (2 psi).

In such cases, special features may be employed in the mechanical design:

- Through-bolting panel connection
- Shear clips
- Downcomer spreaders
- Explosion doors

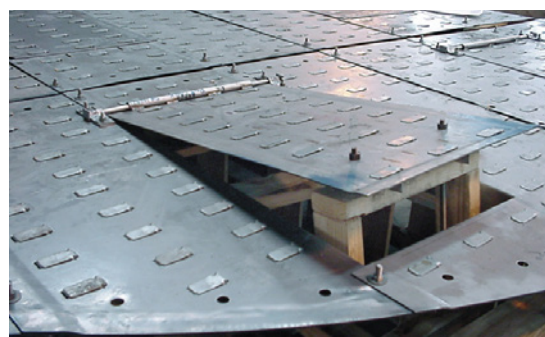

2 psi uplift BDH™ tray equipped with through-bolting assembly, shear clips and explosion doors.

Horizontally installed trays

Some projects require the trays to be installed at the vessel fabricator workshop. In such cases, the installation will be done with the vessel in the horizontal position.

Sulzer has developed a specific procedure for horizontal installation and transportation of trays which:

- Avoids partial deformation and breakage
- Avoids panel shifting
- Avoids joint dislodgment
- Reduces additional inspection at site
- Avoids parts readjustment at site
- Minimizes installation time
- Minimizes cost

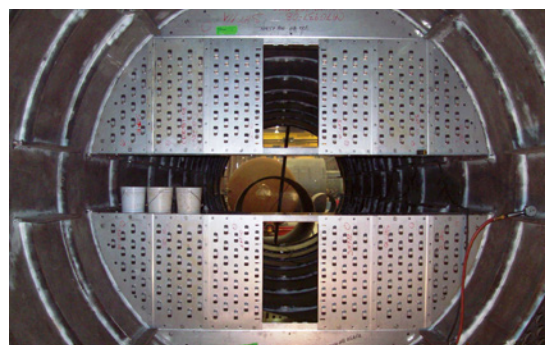

Horizontally installed trays

Lip-Slot™ panel connection

The Lip-Slot is an enhanced type of tray panel connection which allows for:

- safe and easy installation
- up to 30% less installation time
- less maintenance costs as it does not use any bolted connection
- same mechanical reliability as conventional connections

The Lip-Slot is combined with universal clamps for the fixation around the tray periphery.

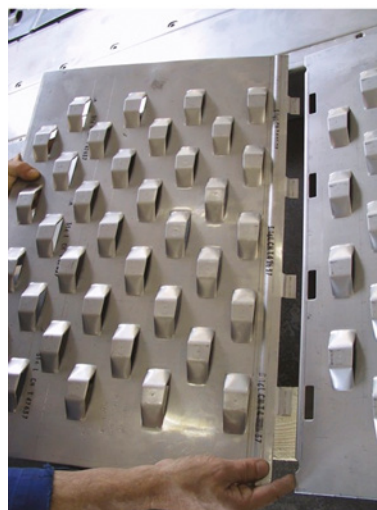

MVG tray equipped with Lip-Slot panels connection

Services

Computer-Aided Engineering (CAE): 3D Models

Upfront engineering and design play a crucial role in cost optimization. Sulzer has integrated all major mass transfer products into an in-house design tool, creating a global standard.

Customers profit directly from the use of our internal CAE tool. Layout drawings supplied in the course of the engineering phase will show a 3D sketch of the equipment being designed, for an easy and fast checking by the customer.



Natural Frequency Analysis for Tray Vibration Phenomena

In some critical applications and under specific operating conditions, vibration phenomena may be induced to the trays. Based on plant feed-back data and in-house know-how, Sulzer has developed a design tool to check for the following two main parameters:

- Natural frequency of the tray panels, as a function of the geometry, the supports, and the material of construction.
- Vibration factor, as a function of the flow rates and physical properties of the streams being processed.

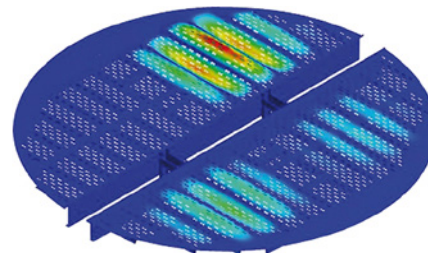

Natural frequency analysis of a full tray

Finite Elements Method (FEM) and Computational Fluid Dynamics (CFD)

Sulzer also employs other advanced design tools, for example verification of mechanical integrity and functionality using finite element and CFD analysis.

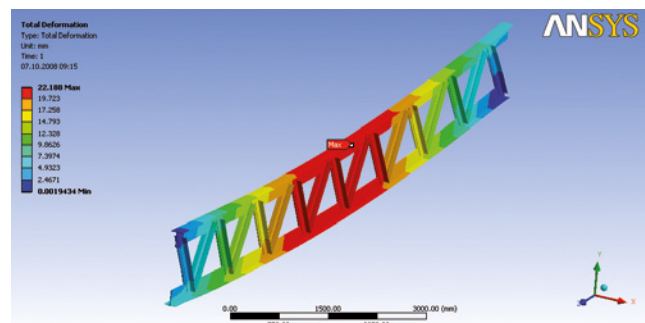

Turn Around and Tower Field Services

Sulzer's global manufacturing capabilities ensure fast delivery of any tray hardware and replacement tray parts, regardless of original supplier. These can be manufactured from existing drawings or damaged parts and supplied on site quickly to meet your turnaround schedules. Replacement hardware can be supplied on consignment in lockers or trailers for convenience.



Customer Hydraulic Design Software SULCOL

SULCOL is the latest, state-of-the-art design tool for mass transfer columns. It is available to customers via the Sulzer website.

Tray hydraulic design and rating

- Fixed and movable valves
- One pass and multipass tray design
- Conventional downcomer design
- Description of Sulzer tray portfolio including Shell tray technology

The screenshot displays the SULCOL software interface for tray design. It is divided into two sections, 'Sec. 1' and 'Sec. 2'.

Section 1: Packing

Diams [mm]	Fluid Data	Packing Design	Packing Type	Height [m]	NTS req.	HETP [mm]
3048	Fluid_2	Packing2	M250.Y	5.096	0.0	0

Flows

	G [kg/h]	L [kg/h]	ρ [kg/m ³]	ρ L [kg/h]	ρ L [m ³ /h]	ρ L [m ³ /h]	ρ L [m ³ /h]	Cap [°]	FF [m ² /h]	Liq load [m ³ /h]	Asp/A.z [m ² /h]	H [m]	dp [mbar]
Top	204116.6	108862.2	19.222	720.83	12.00	0.200	0.0100	73.4	1.77	20.70	1.41	3.8	8.97
Botm	204116.6	108862.2	19.222	720.83	12.00	0.200	0.0100	73.4	1.77	20.70	1.41	3.8	8.97

Text: System factor 1.00

Geom. Details

Section 2: Tray

Diams [mm]	Fluid Data	Tray Design	Tray Type	DC Type	# Plat. Spac. [mm]	# Trays	Height [m]	NTS required	Effic. [%]
3048	Fluid_3	Tray1	BMV	STAND	T	610	10	5.486	0

Flows

	G [kg/h]	L [kg/h]	ρ [kg/m ³]	ρ L [kg/h]	ρ L [m ³ /h]	ρ L [m ³ /h]	ρ L [m ³ /h]	Jet Fl. [°]	Weir load [m ³ /h]	Asp/Tray [m ² /h]	dc [m]	DC vel [m/s]	DC slip [m/s]	DC slip [%]
Load 1	204116.6	108862.2	19.222	720.83	12.00	0.200	0.0100	58	174.91	5.77	24.70	0.080	48	
Load 2	204116.6	108862.2	19.222	720.83	12.00	0.200	0.0100	58	174.91	5.77	24.70	0.080	48	

Text: System factor 1.00

Geom. Details

Total sections: 2

Column data: p top [mbar] 0.00, Δ p total [mbar] 66.25

Current Section: 1

You may download SULCOL from www.sulzer.com

